

Powerex, Inc., 200 Hillis Street, Youngwood, Pennsylvania 15697-1800 (724) 925-7272

Fast Recovery Diode Module
600 Amp/1400 Volts

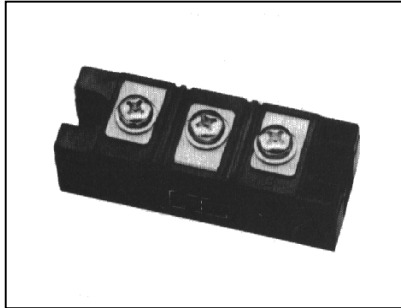
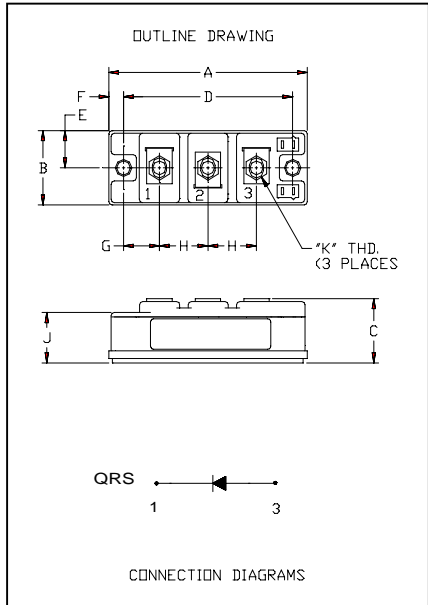

QRS1460T30
Fast Recovery Diode Module
600 Amperes / 1400 Volts

Description:

Powerex Fast Recovery Diode Modules are designed for use in applications requiring fast switching. The modules are isolated for easy mounting with other components on a common heatsink.

Features:

- Fast Recovery Time
- Isolated Mounting
- Metal Baseplate
- Low Thermal Impedance
- 3000 V isolating voltage

Applications:

- Switching Power Supplies
- Inverters
- Choppers
- Welding Power Supplies
- Free Wheeling Diode
- High Frequency Rectifiers

Dimensions	Inches	Millimeters
A	3.70	94
B	1.34	34
C	1.18	30
D	3.15	80
E	0.67	17
F	0.28	6.99
G	0.67	17.1
H	0.91	23
J	0.91	23
K	M6X1.0	M6X1.0

Powerex, Inc., 200 Hillis Street, Youngwood, Pennsylvania 15697-1800 (724) 925-7272

Fast Recovery Diode Module
600 Amp/1400 Volts**Absolute Maximum Ratings, $T_J=25^\circ\text{C}$ unless otherwise specified**

Characteristics	Conditions	Symbol	QRS1460T30	Units
Repetitive Peak Reverse Blocking Voltage	-	V_{RRM}	1400	Volts
Non-Repetitive Peak Reverse Blocking Voltage	-	V_{RSM}	$V_{RRM} + 100$	Volts
Average Forward Current	180° Conduction, $T_c=25^\circ\text{C}$	$I_{F(AV)}$	600	Amperes
Peak Half Cycle Non-Repetitive Surge Current	$t = 8.3\text{mS}$, 100% V_{RRM} Reapplied	I_{FSM}	4000	Amperes
I^2t for Fusing for One Cycle	$t = 8.3\text{mS}$, 100% V_{RRM} Reapplied	I^2t	66670	A^2sec
Operating Junction Temperature	-	T_J	-40 to 150	$^\circ\text{C}$
Storage Temperature	-	T_{STG}	-40 to 150	$^\circ\text{C}$
Maximum Mounting Torque, M6 Mounting Screw	-	-	26	In.-lb.
Maximum Terminal Torque, M6 Terminal Screw	-	-	26	In.-lb.
Module Weight (Typical)	-	-	220	Grams
V Isolation	60 Hz, circuit to base, all terminals shorted, $t = 1 \text{ sec}$	V_{RMS}	3000	Volts

Electrical Characteristics, $T_J=25^\circ\text{C}$ unless otherwise specified

Characteristics	Symbol	Test Conditions	Min.	Typ.	Max.	Units
Peak Reverse Leakage Current	I_{RRM}	Rated V_{RRM}	-	-	2	mA
Peak On-State Voltage	V_{FM}	$I_F=600\text{A}$	-	-	3.8	Volts
Reverse Recovery Time	t_{rr}	$I_F = 600\text{A}$, $di/dt = -1200\text{A}/\mu\text{s}$	-	-	300	ns
Reverse Recovery Charge	Q_{rr}	$I_F = 600\text{A}$, $di/dt = -1200\text{A}/\mu\text{s}$	-	6.0	-	μC

Thermal Characteristics, $T_J=25^\circ\text{C}$ unless otherwise specified

Characteristics	Symbol	Min.	Typ.	Max.	Units
Thermal Resistance, Junction to Case	$R_{\theta JC}$	-	-	0.06	$^\circ\text{C}/\text{Watt}$
Thermal Resistance, Case to Sink Lubricated	$R_{\theta CS}$	-	-	0.04	$^\circ\text{C}/\text{Watt}$

Powerex, Inc., 200 Hillis Street, Youngwood, Pennsylvania 15697-1800 (724) 925-7272

Fast Recovery Diode Module 600 Amp/1400 Volts

