

Silicon Schottky Diodes

- For low-loss, fast-recovery, meter protection, bias isolation and clamping applications
- Integrated diffused guard ring
- Low forward voltage

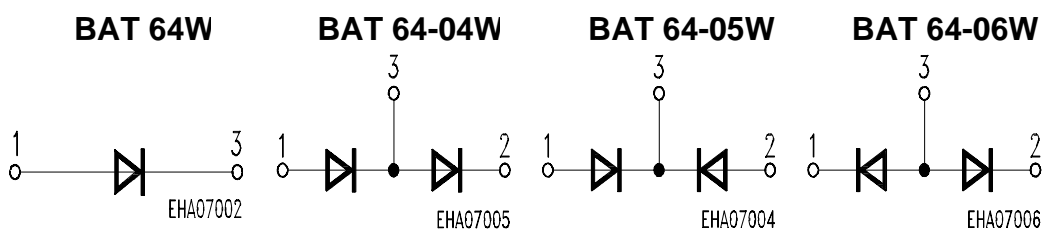
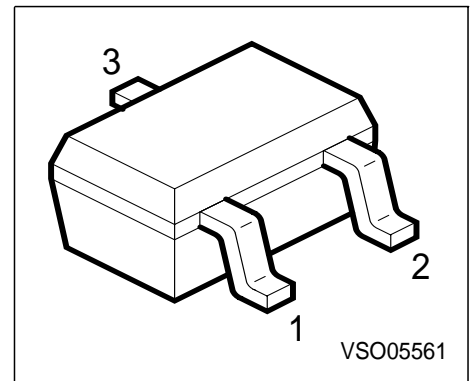

ESD: Electrostatic discharge sensitive device, observe handling precaution!

Type	Marking	Ordering Code	Pin Configuration			Package
BAT 64W	63s	Q62702-A1159	1 = A	2 n.c.	3 = C	SOT-323
BAT 64-04W	64s	Q62702-A1160	1 = A1	2 = C2	3 = C1/A2	
BAT 64-05W	65s	Q62702-A1161	1 = A1	2 = A2	3 = C1/2	
BAT 64-06W	66s	Q62702-A1162	1 = C1	2 = C2	3 = A1/2	

Maximum Ratings

Parameter	Symbol	Value	Unit
Diode reverse voltage	V_R	40	V
Forward current	I_F	250	mA
Average forward current (50/60Hz, sinus)	I_{FAV}	120	
Surge forward current ($t < 100\mu s$)	I_{FSM}	800	
Total power dissipation BAT 64W, $T_S \leq 120^\circ C$	P_{tot}	250	
Total power dissipat. BAT64-04/06W, $T_S \leq 111^\circ C$	P_{tot}	250	
Total power dissipation BAR 64-05W, $T_S \leq 104^\circ C$	P_{tot}	250	
Junction temperature	T_j	150	$^\circ C$
Storage temperature	T_{stg}	-55...+150	

Thermal Resistance

Junction - ambient	¹⁾ BAT 64W	R_{thJA}	≤ 255	K/W
Junction - ambient	¹⁾ BAT 64-04/06W	R_{thJA}	≤ 290	
Junction - ambient	¹⁾ BAT 64-05W	R_{thJA}	≤ 455	
Junction - soldering point	BAT 64W	R_{thJS}	≤ 120	
Junction - soldering point	BAT 64-04/06W	R_{thJS}	≤ 155	
Junction - soldering point	BAT 64-05W	R_{thJS}	≤ 185	

¹⁾ Package mounted on epoxy pcb 40mm x 40mm x 1.5mm / 6cm² Cu

Electrical Characteristics at $T_A = 25\text{ }^\circ\text{C}$, unless otherwise specified.

Parameter	Symbol	Values			Unit
		min.	typ.	max.	

DC characteristics

Reverse current $V_R = 30\text{ V}$	I_R	-	-	2	μA
Reverse current $V_R = 30\text{ V}, T_A = 85\text{ }^\circ\text{C}$	I_R	-	-	200	
Forward voltage $I_F = 1\text{ mA}$ $I_F = 10\text{ mA}$ $I_F = 30\text{ mA}$ $I_F = 100\text{ mA}$	V_F	-	320 385 440 570	350 430 520 750	mV

AC characteristics

Diode capacitance $V_R = 1\text{ V}, f = 1\text{ MHz}$	C_T	-	4	6	pF
---	-------	---	---	---	-------------

Forward current $I_F = f(V_F)$

$T_A = \text{Parameter}$

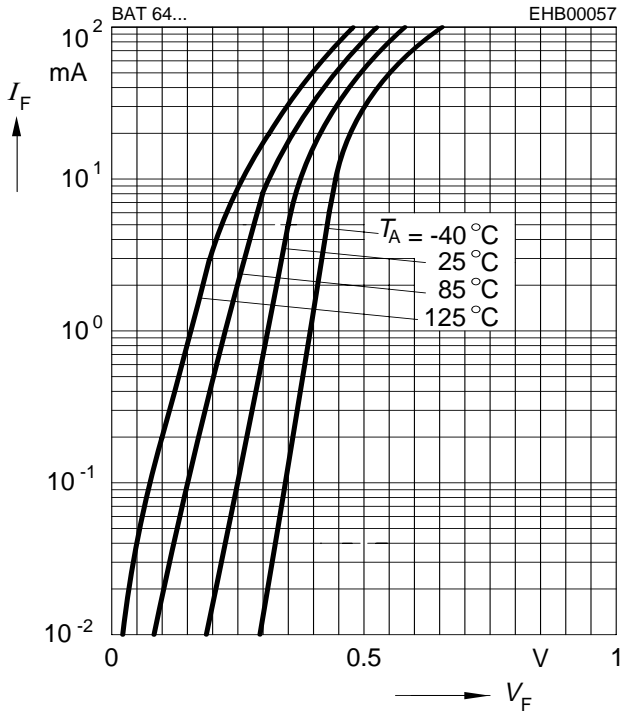

Reverse current $I_R = f(V_R)$

$T_A = \text{Parameter}$

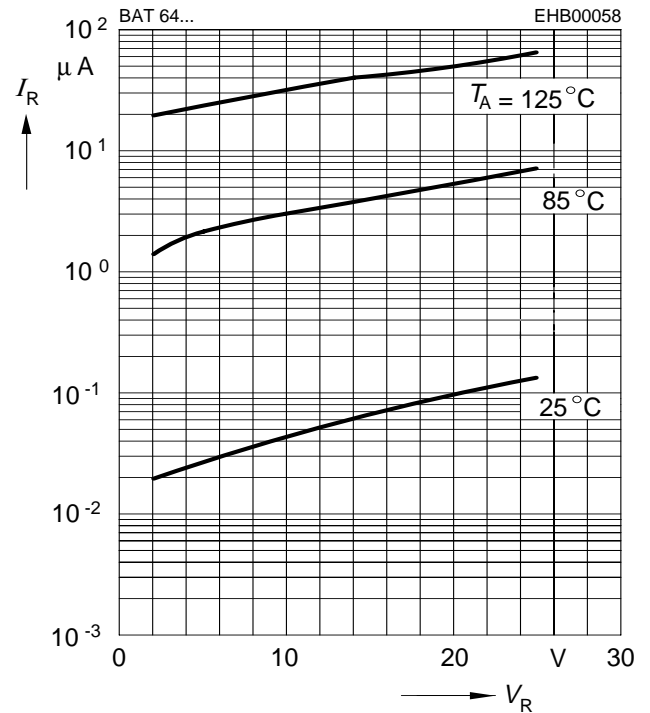

Forward current $I_F = f(T_A^*; T_S)$

*Package mounted on epoxy

BAT 64W

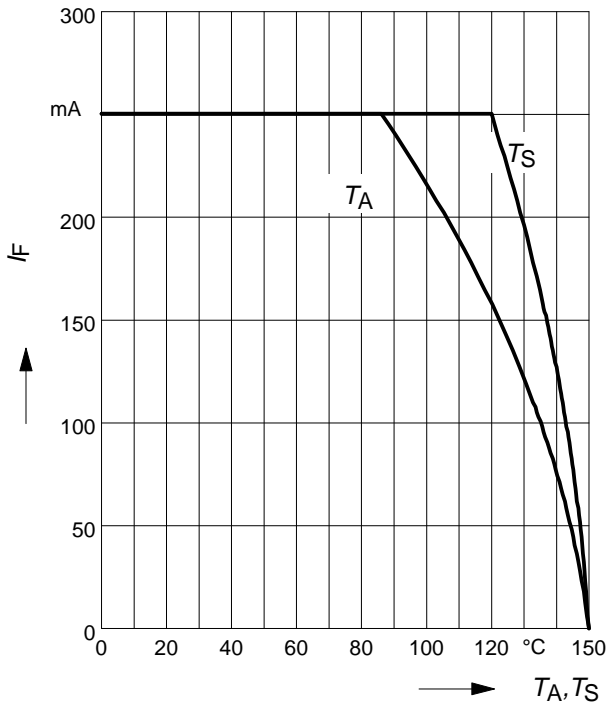

Permissible Pulse Load $R_{thJS} = f(t_p)$

BAT 64W

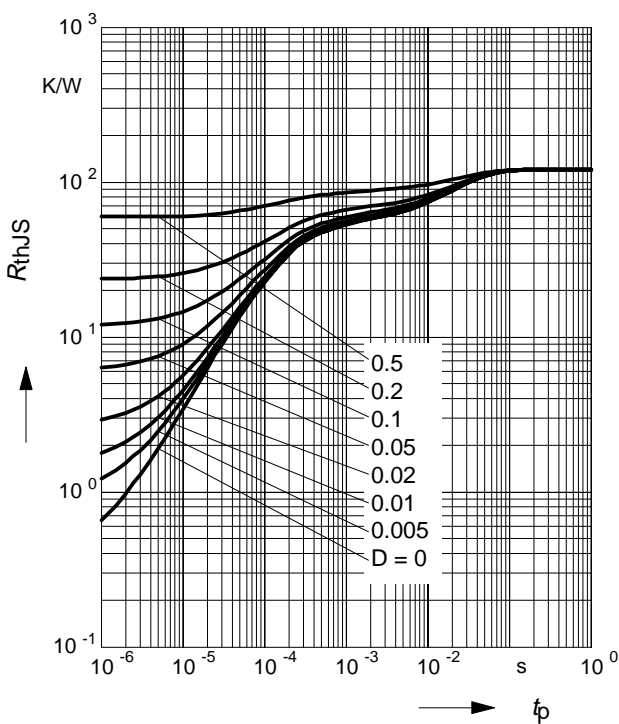

Permissible Pulse Load $I_{Fmax} / I_{FDC} = f(t_p)$

BAT 64W

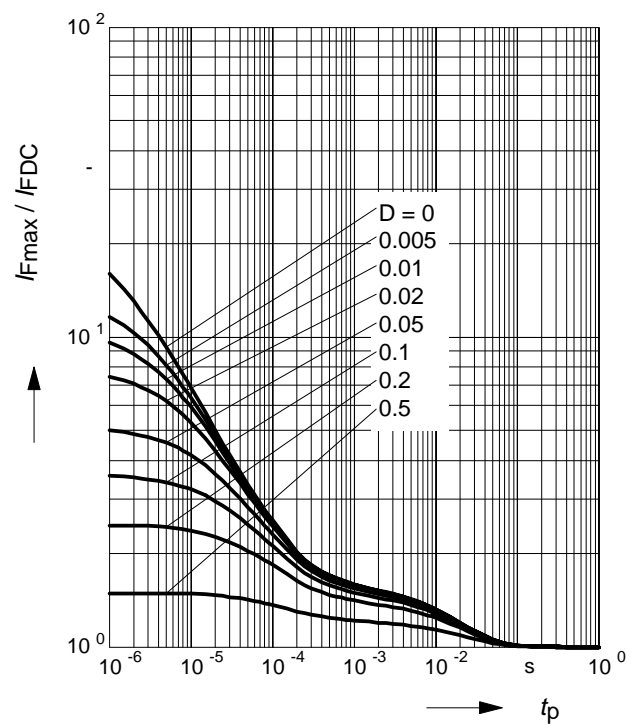

Forward current $I_F = f(T_A^*; T_S)$

* Package mounted on epoxy

BAT 64-04/06W

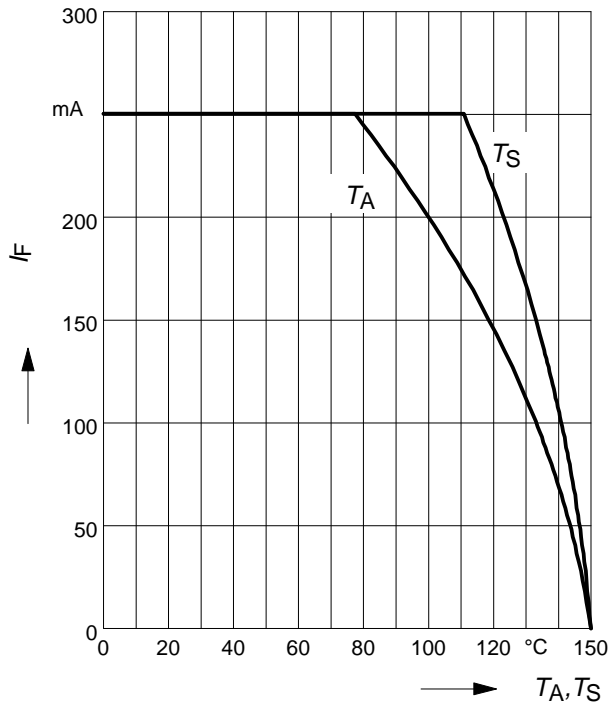

Permissible Pulse Load $R_{thJS} = f(t_p)$

BAT 64-04/06

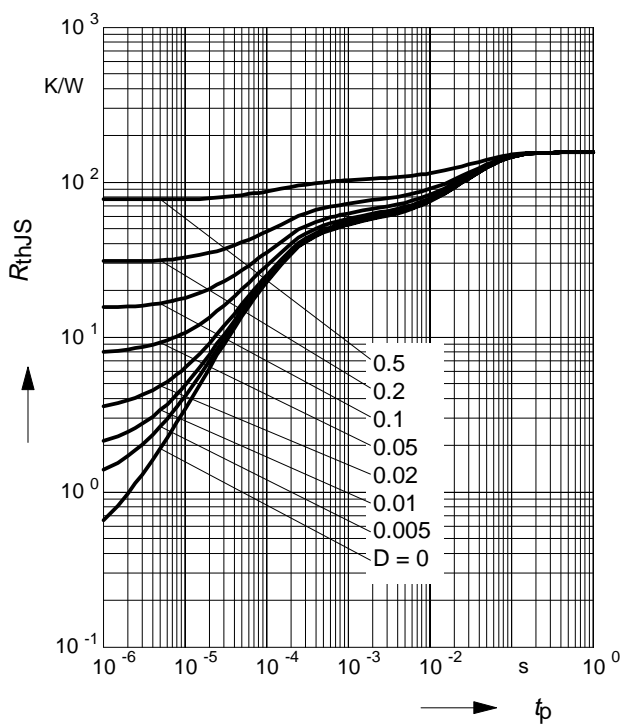

Permissible Pulse Load $I_{Fmax} / I_{FDC} = f(t_p)$

BAT 64-04/06W

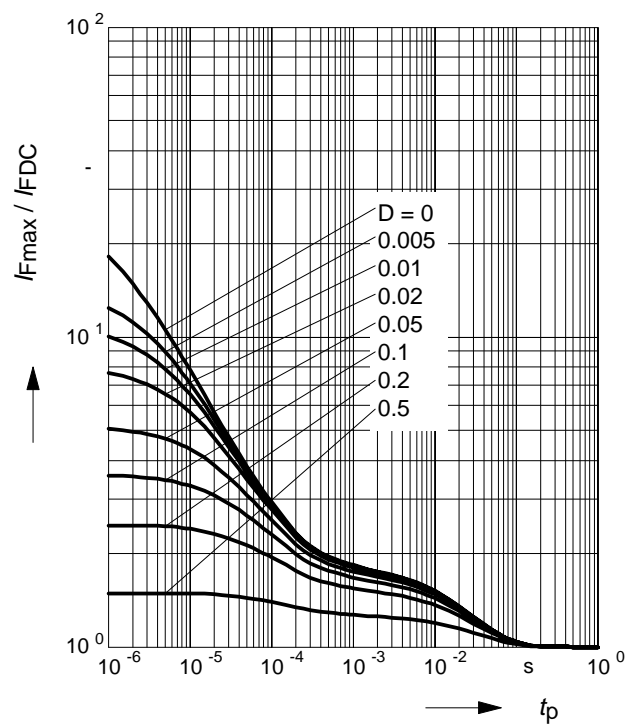

Forward current $I_F = f(T_A^*; T_S)$

* Package mounted on epoxy

BAT 64-05W

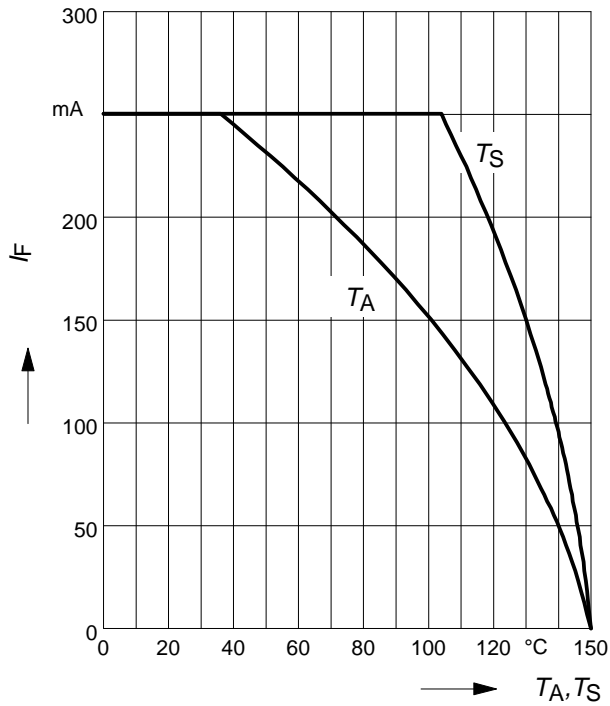

Permissible Pulse Load $R_{thJS} = f(t_p)$

BAT 64-05W

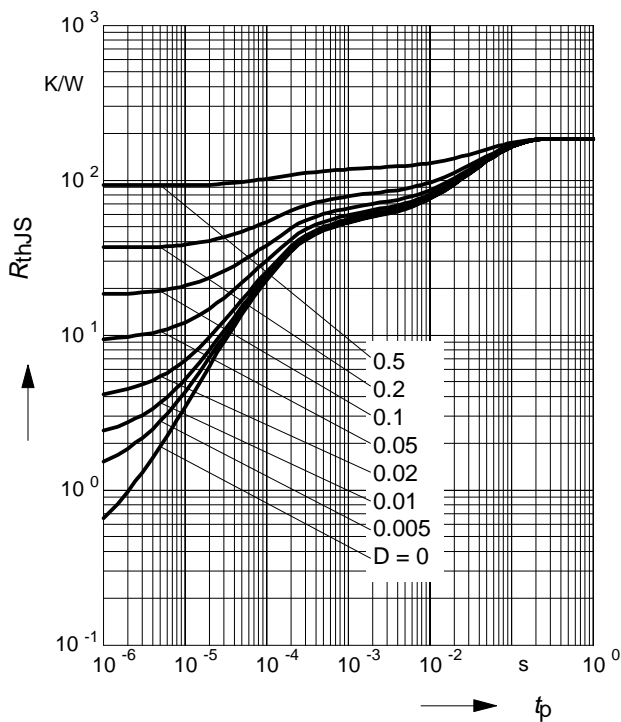

Permissible Pulse Load $I_{Fmax} / I_{FDC} = f(t_p)$

BAT 64-05W

