

# KA239/KA239A, KA339/KA339A KA3302, KA2901

## Quad Comparator

### Features

- Single or dual supply operation
- Wide range of supply voltage  
KA239/KA239A, KA339/KA339A, KA2901 : 2 ~ 36V  
(or  $\pm 1 \sim \pm 18V$ )  
KA3302 : 2 ~ 28V (or  $\pm 1 \sim \pm 14V$ )
- Low supply current drain 800 $\mu A$  Typ.
- Open collector outputs for wired and connectors
- Low input bias current 25nA Typ.
- Low Input offset current  $\pm 2.3nA$  Typ.
- Low input offset voltage  $\pm 1.4mV$  Typ.
- Common mode input voltage range includes ground.
- Low output saturation voltage
- Output compatible with TTL, DTL and MOS logic system

### Description

The KA239/KA239A, KA339/KA339A, KA3302, KA2901 consist of four independent voltage comparators designed to operate from single power supply over a wide voltage range.

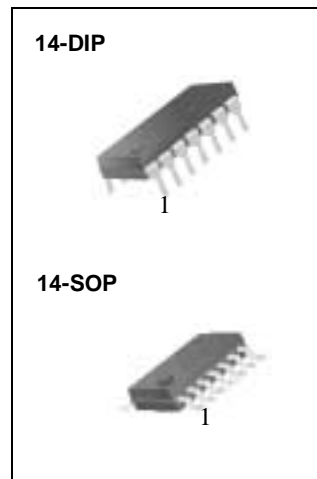

### Internal Block Diagram

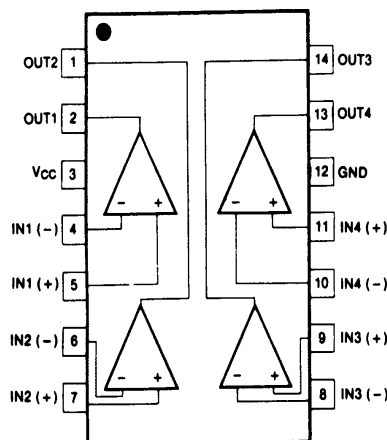

## Schematic Diagram

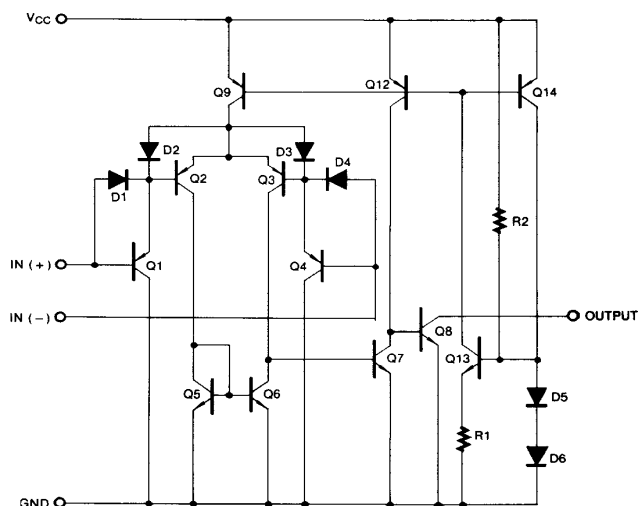

## Absolute Maximum Ratings

Parameter	Symbol	Value	Unit
Supply Voltage	VCC	±18 or 36	V
Supply Voltage Only KA3302	VCC	±14 or 28	V
Differential Input Voltage	V <sub>I(DIFF)</sub>	36	V
Differential Input Voltage Only KA3302	V <sub>I(DIFF)</sub>	28	V
Input Voltage	V <sub>I</sub>	- 0.3 to +36	V
Input Voltage Only KA3302	V <sub>I</sub>	- 0.3 to +28	V
Output Short Circuit to GND	-	Continuous	-
Power Dissipation	PD	570	mW
Operating Temperature KA339/KA339A KA239/KA239A KA2901/KA3302	TOPR	0 ~ + 70 - 25 ~ + 85 - 40 ~ + 85	°C
Storage Temperature	TSTG	- 65 ~ + 150	°C

## Electrical Characteristics

(VCC = 5V, TA = 25°C, unless otherwise specified)

Parameter	Symbol	Conditions	KA239A/KA339A			KA239/KA339			Unit	
			Min.	Typ.	Max.	Min.	Typ.	Max.		
Input Offset Voltage	V <sub>IO</sub>	VO(P) = 1.4V, RS = 0Ω	-	±1	±2	-	±1.4	±5	mV	
		Note 1	-		±4.0	-	-	±9.0		
Input Offset Current	I <sub>IO</sub>		-	±2.3	±50	-	±2.3	±50	nA	
		Note 1	-		±150	-	-	±150		
Input Bias Current	I <sub>BIAS</sub>		-	57	250	-	57	250	nA	
		Note 1	-	-	400	-	-	400		
Input Common Mode Voltage Range	V <sub>I(R)</sub>		0	-	VCC-1.5	0	-	VCC-1.5	V	
		Note 1	0	-	VCC-2	0	-	VCC-2		
Supply Current	I <sub>CC</sub>	VCC = 5V RL = ∞	-	1.1	2.0	-	1.1	2.0	mA	
Voltage Gain	G <sub>V</sub>	VCC = 15V, RL ≥ 15KΩ (for large swing)	50	200	-	50	200	-	V/mV	
Large Signal Response Time	T <sub>LRES</sub>	V <sub>I</sub> = TTL Logic Swing V <sub>REF</sub> = 1.4V, V <sub>RL</sub> = 5V, RL = 5.1KΩ	-	350	-	-	350	-	ns	
Response Time	T <sub>RES</sub>	V <sub>RL</sub> = 5V, RL = 5.1KΩ	-	1.4	-	-	1.4	-	μs	
Output Sink Current	I <sub>SINK</sub>	V <sub>I(-)</sub> ≥ 1V, V <sub>I(+)</sub> = 0V, V <sub>O(P)</sub> ≤ 1.5V	6	18	-	6	18	-	mA	
Output Saturation Voltage	V <sub>SAT</sub>	V <sub>I(-)</sub> ≥ 1V, V <sub>I(+)</sub> = 0V	-	140	400	-	140	400	mV	
		I <sub>SINK</sub> = 4mA	Note 1		700	-		700		
Output Leakage Current	I <sub>o(LKG)</sub>	V <sub>I(-)</sub> = 0V		0.1	-	-	0.1	-	nA	
		V <sub>I(+)</sub> = 1V	V <sub>O(P)</sub> = 5V	-	-	1.0	-	-	1.0	μA
Differential Voltage	V <sub>I(DIFF)</sub>		Note 1	-	-	36	-	-	36	V

### Note 1.

KA339 / KA339A: 0 ≤ TA ≤ +70°C

KA239 / KA239A: -25 ≤ TA ≤ +85°C

KA2901 / KA3302: -40 ≤ TA ≤ +85°C

## Electrical Characteristics (Continued)

(VCC = 5V, TA = 25°C, unless otherwise specified)

Parameter	Symbol	Conditions	KA2901			KA3302			Unit
			Min.	Typ.	Max.	Min.	Typ.	Max.	
Input Offset Voltage	V <sub>IO</sub>	V <sub>O(P)</sub> = 1.4V, R <sub>S</sub> = 0Ω	-	2	7	-	2	20	mV
		Note 1	-	9	15	-	-	40	
Input Offset Current	I <sub>IO</sub>		-	2.3	50	-	3	100	nA
		Note 1	-	50	200	-	-	300	
Input Bias Current	I <sub>BIAS</sub>		-	57	250	-	57	250	nA
		Note 1	-	200	500	-	-	1000	
Input Common Mode Voltage Range	V <sub>I(R)</sub>		0	-	V <sub>CC</sub> -1.5	0	-	V <sub>CC</sub> -1.5	V
		Note 1	0	-	V <sub>CC</sub> -2	0	-	V <sub>CC</sub> -2	
Supply Current	I <sub>CC</sub>	R <sub>L</sub> = ∞, V <sub>CC</sub> = 5V	-	1.1	2.0	-	1.1	2.0	mA
		R <sub>L</sub> = ∞, V <sub>CC</sub> = 30V	-	1.6	2.5	-	-	-	
Voltage Gain	G <sub>V</sub>	V <sub>CC</sub> = 15V, R <sub>L</sub> ≥ 15KΩ (for large swing)	25	100	-	2	30	-	V/mV
Large Signal Response Time	T <sub>LR</sub>	V <sub>I</sub> = TTL Logic Swing V <sub>REF</sub> = 1.4V, V <sub>R</sub> = 5V, R <sub>L</sub> = 5.1KΩ	-	350	-	-	350	-	ns
Response Time	T <sub>RES</sub>	V <sub>R</sub> = 5V, R <sub>L</sub> = 5.1KΩ	-	1.4	-	-	1.4	-	μs
Output Sink Current	I <sub>SINK</sub>	V <sub>I(-)</sub> ≥ 1V, V <sub>I(+)</sub> = 0V, V <sub>O(P)</sub> ≤ 1.5V	6	18	-	6	18	-	mA
Output Saturation Voltage	V <sub>SAT</sub>	V <sub>I(-)</sub> ≥ 1V, V <sub>I(+)</sub> = 0V I <sub>SINK</sub> = 4mA	-	140	400	-	140	400	mV
		Note 1	-	-	700	-	-	700	
Output Leakage Current	I <sub>O(LKG)</sub>	V <sub>I(-)</sub> = 0V	-	0.1	-	-	0.1	-	nA
		V <sub>I(+)</sub> = 1V	-	-	1.0	-	-	1.0	μA
Differential Voltage	V <sub>I(DIFF)</sub>	Note 1	-	-	36	-	-	36	V

Note 1.

KA339 / KA339A: 0 ≤ T<sub>A</sub> ≤ +70°C

KA239 / KA239A: -25 ≤ T<sub>A</sub> ≤ +85°C

KA2901 / KA3302: -40 ≤ T<sub>A</sub> ≤ +85°C

# Typical Performance Characteristics

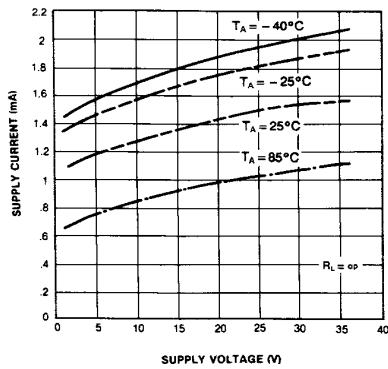

Figure 1. Supply Current vs Supply Voltage

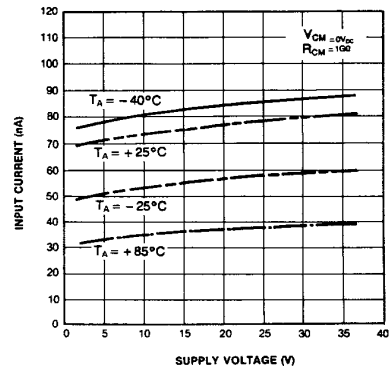

Figure 2. Input Current vs Supply Voltage

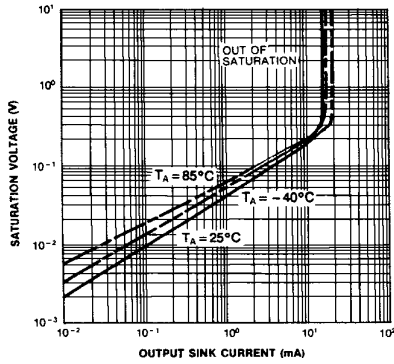

Figure 3. Output Saturation Voltage vs sink Current

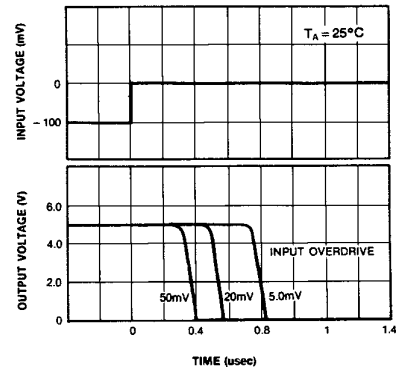

Figure 4. Response Time for Various Input Overdrive-Negative Transition

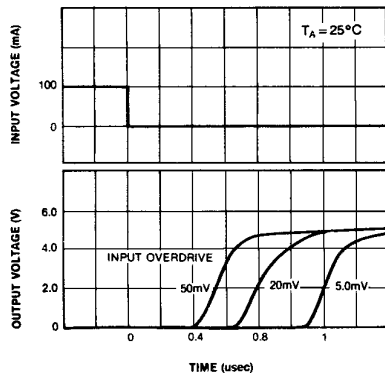
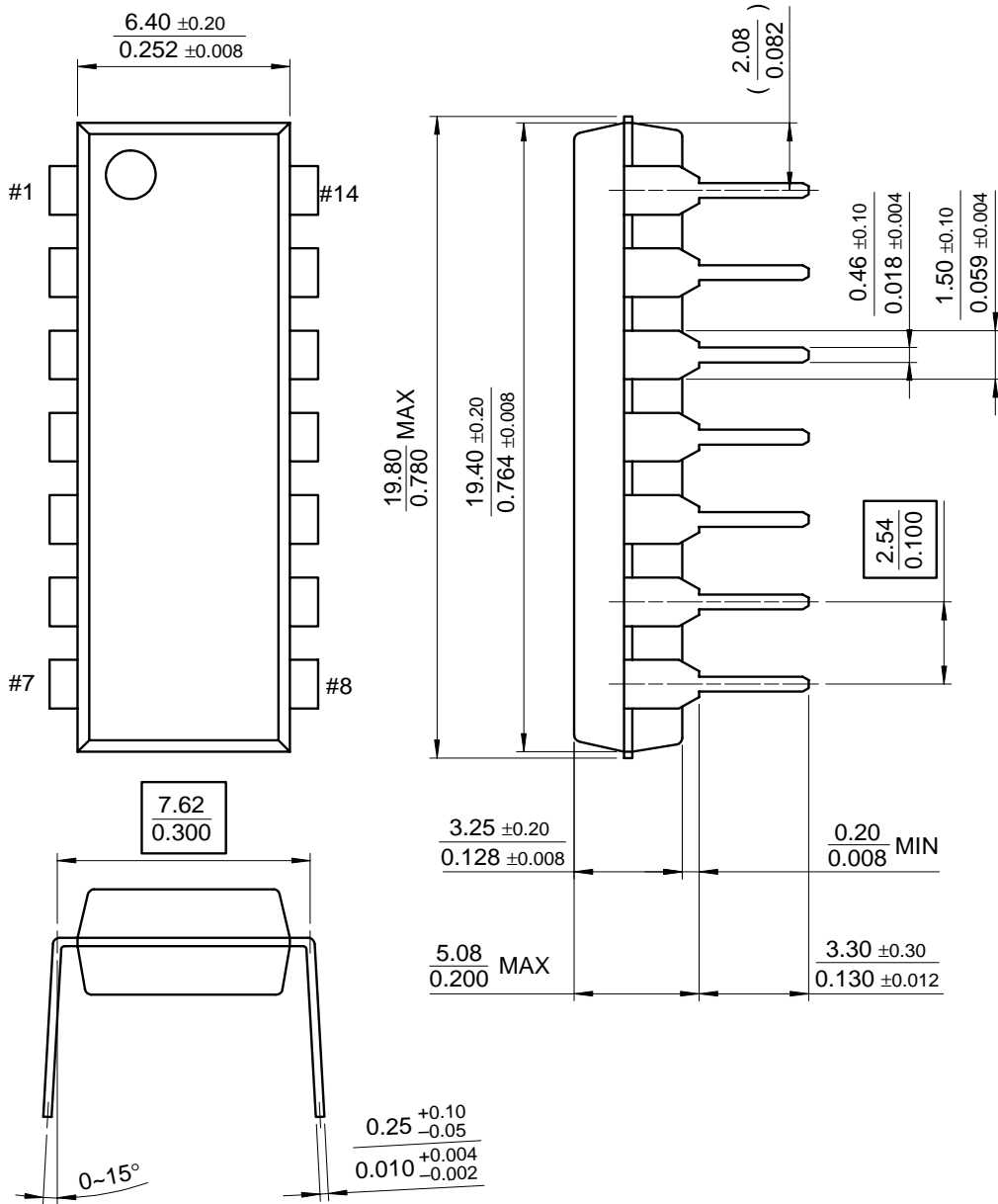

Figure 5. Response Time for Various Input Overdrive-Positive Transition

# Mechanical Dimensions

## Package

### 14-DIP



**Mechanica Dimensions** (Continued)

**Package**

**14-SOP**

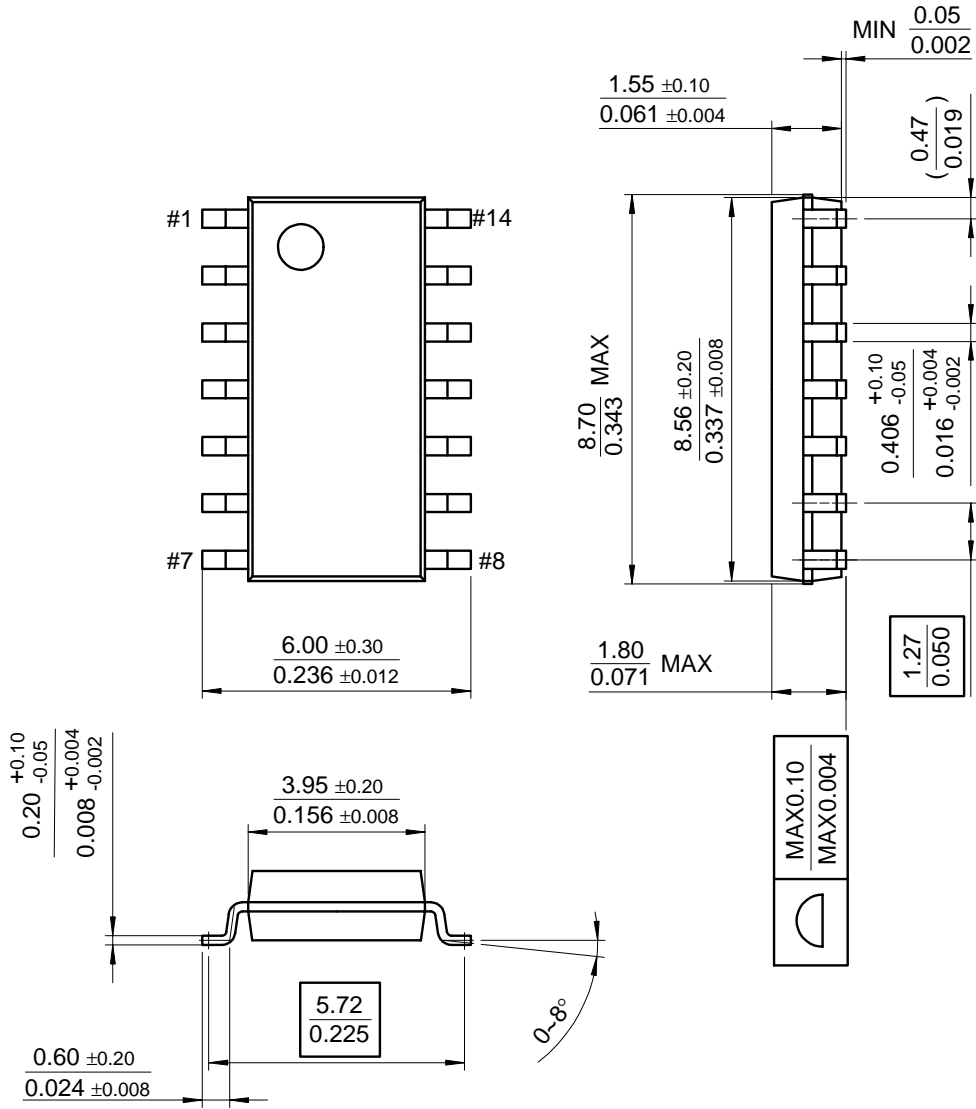

## Ordering Information

Product Number	Package	Operating Temperature
KA339	14-DIP	0 ~ + 70°C
KA339A		
KA339D	14-SOP	
KA339AD		
KA239	14-DIP	-25 ~ + 85°C
KA239A		
KA239D	14-SOP	
KA239AD		
KA2901	14-DIP	-40 ~ + 85°C
KA2901D	14-SOP	
KA3302	14-DIP	
KA3302D	14-SOP	





#### **DISCLAIMER**

FAIRCHILD SEMICONDUCTOR RESERVES THE RIGHT TO MAKE CHANGES WITHOUT FURTHER NOTICE TO ANY PRODUCTS HEREIN TO IMPROVE RELIABILITY, FUNCTION OR DESIGN. FAIRCHILD DOES NOT ASSUME ANY LIABILITY ARISING OUT OF THE APPLICATION OR USE OF ANY PRODUCT OR CIRCUIT DESCRIBED HEREIN; NEITHER DOES IT CONVEY ANY LICENSE UNDER ITS PATENT RIGHTS, NOR THE RIGHTS OF OTHERS.

#### **LIFE SUPPORT POLICY**

FAIRCHILD'S PRODUCTS ARE NOT AUTHORIZED FOR USE AS CRITICAL COMPONENTS IN LIFE SUPPORT DEVICES OR SYSTEMS WITHOUT THE EXPRESS WRITTEN APPROVAL OF THE PRESIDENT OF FAIRCHILD SEMICONDUCTOR CORPORATION. As used herein:

1. Life support devices or systems are devices or systems which, (a) are intended for surgical implant into the body, or (b) support or sustain life, and (c) whose failure to perform when properly used in accordance with instructions for use provided in the labeling, can be reasonably expected to result in a significant injury of the user.
2. A critical component in any component of a life support device or system whose failure to perform can be reasonably expected to cause the failure of the life support device or system, or to affect its safety or effectiveness.