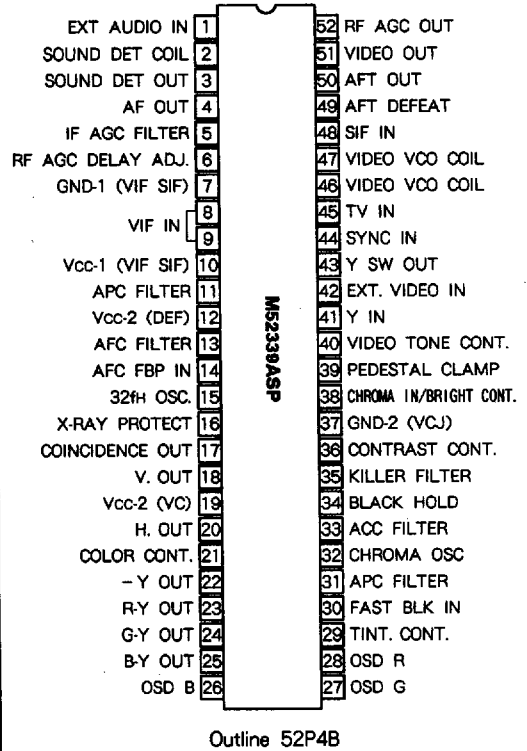

**M52339ASP****NTSC SYSTEM SINGLE-CHIP COLOR TV SIGNAL PROCESSOR****DESCRIPTION**

The M52339ASP semiconductor integrated circuit has all necessary functions to process NTSC color TV signals. This single chip is able to handle video intermediate frequency, sound intermediate frequency, video signals, color signals, on-screen character indication signals, and deflection signals. A streamlined NTSC color TV set can be produced by combining this IC with a simple output stage including a tuner and transistor.

**FEATURES**

- This IC itself is relatively large, simplifying TV set construction, improving reliability, and saving energy.
  - A completely synchronous detection circuit with a phase-locked loop is used as the video detector, ensuring excellent performance in differential gain control, differential phase control, beat frequency (920kHz) control, and cross-color prevention.
  - A quadrature detection circuit is provided as the sound intermediate frequency modulation detector, reducing the number of externally connected circuits and improving linearity.
  - Automatic fine-tuning (AFT) control has no coil.
  - Able to perform "AFT defeat," video muting and sound muting.
  - Horizontal oscillation is obtained by "counting down" horizontal frequency that is amplified 32 times by ceramic oscillator. No adjustment is necessary for horizontal free-run frequency.
  - Vertical oscillation is obtained by counting down the horizontal frequency that is generated by "horizontal countdown." This frequency is amplified twice. No adjustment is necessary for vertical synchronous frequency.
  - Double automatic frequency control is used in the horizontal output circuit, minimizing horizontal jitter in the weak electric field and image warping due to irregularity in brightness.
- Thanks to a synchronous detection circuit, signals can be used for detection in sound muting and automatic channel selection.
- Black expansion circuit is built in.
  - Y-delay line circuit is built in.
  - On-screen character indication circuit is built in.
- Image quality, contrast, brightness, color saturation, tint and sound volume are controlled independently with DC voltage.

**PIN CONFIGURATION (TOP VIEW)****APPLICATION**

NTSC system color TV sets

**RECOMMENDED OPERATING CONDITION**

Supply voltage range.....5V, 9V  
 Rated supply voltage.....4.5~5.5V, 8.5~9.5V  
 Maximum output current.....3.0mA(pin⑧) 6.0mA(pin②)

NTSC SYSTEM SINGLE-CHIP COLOR TV SIGNAL PROCESSOR

BLOCK DIAGRAM

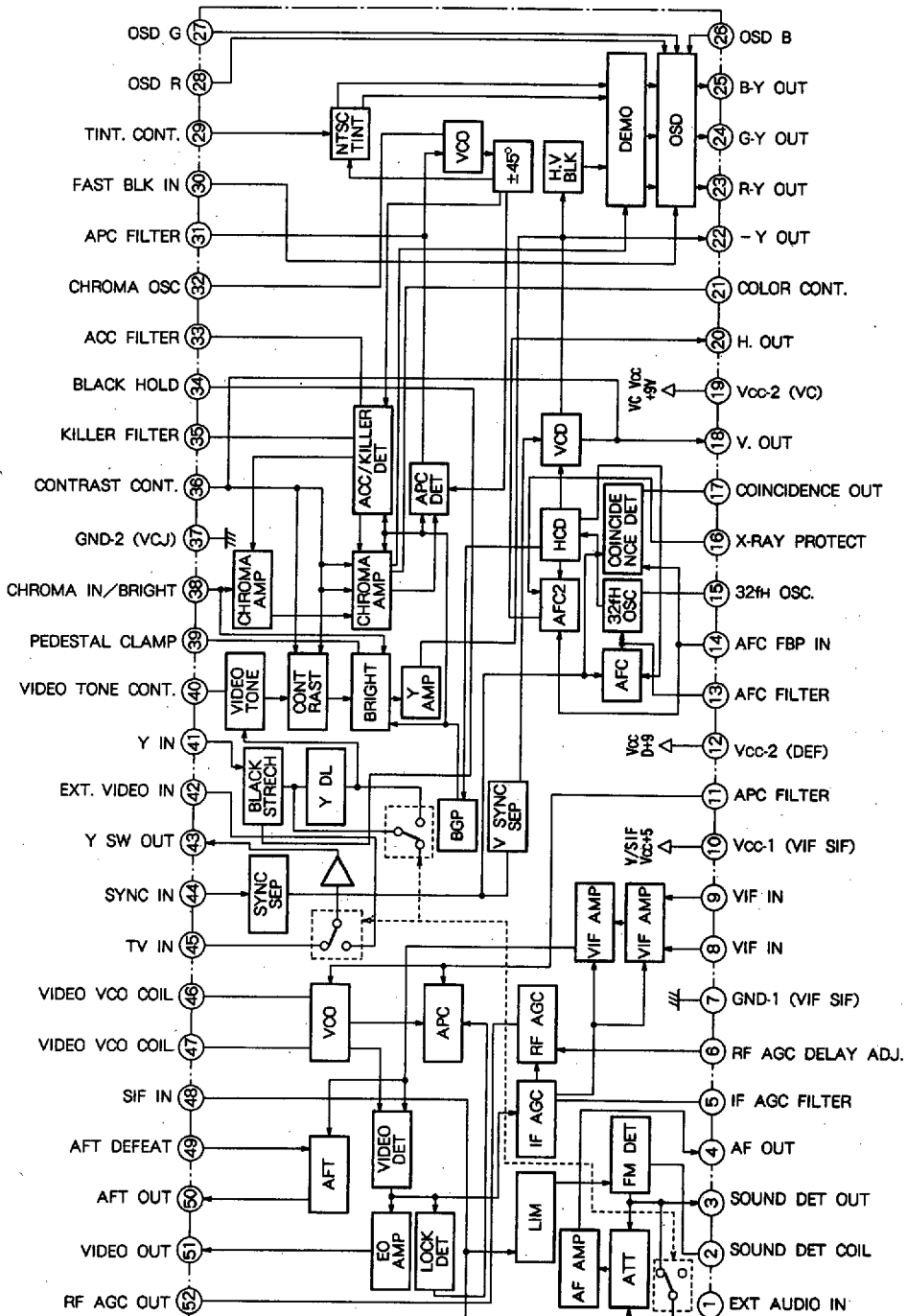

NTSC SYSTEM SINGLE-CHIP COLOR TV SIGNAL PROCESSOR

ABSOLUTE MAXIMUM RATINGS

(V<sub>SS</sub> = 0V)

Symbol	Parameter	Ratings	Unit
V <sub>CC</sub>	Supply voltage	5.0~9.0	V
P <sub>d</sub>	Power dissipation	1.35	W
T <sub>opr</sub>	Operating temperature	-20~+65	°C
T <sub>stg</sub>	Storage temperature	-40~+150	°C

ELECTRICAL CHARACTERISTICS (T<sub>a</sub> = 25°C unless otherwise noted)

Symbol	Parameter	Test point	Input	Test conditions*																Limits			Unit					
				2A	5A	6A	48V	V <sub>CC</sub>	V <sub>CD</sub>	V <sub>CD</sub>	19S	2S	5S	10S	10S	12S	19S	48A	48S	49S	51S	52S		16S	Min.	Typ.	Max.	
I <sub>CC10</sub>	Circuit current	A10	-	-	-	-	-	5.0V	0.0V	-	-	-	-	ON	ON	ON	-	-	1	-	ON	-	-	-	29	38	47	mA
V <sub>51</sub>	Video output DC voltage	51	-	-	-	-	-	5.0V	0.0V	-	ON	-	ON	ON	-	ON	-	-	2	-	ON	-	-	-	3.0	3.3	3.7	V
V <sub>O51</sub>	Video detection output	51	A SG.1	-	-	-	-	5.0V	0.0V	-	ON	-	ON	ON	-	ON	-	-	2	-	ON	-	-	-	1.2	1.4	1.6	V <sub>P-P</sub>
V <sub>51L</sub>	Sync signal peak voltage	51	A SG.2	-	-	-	-	5.0V	0.0V	-	ON	-	ON	ON	-	ON	-	-	2	-	ON	-	-	-	1.5	1.75	1.95	V
V <sub>in min</sub>	Input sensitivity	51A	A SG.3	-	-	-	-	5.0V	0.0V	-	ON	-	ON	ON	-	ON	-	-	2	-	ON	-	-	-	-	48	55	dBμ
V <sub>in max</sub>	Maximum allowable input	51A	A SG.4	-	-	-	-	5.0V	0.0V	-	ON	-	ON	ON	-	ON	-	-	2	-	ON	-	-	-	101	107	-	dBμ
BW	Video frequency characteristic	51	A SG.10	-	-	-	-	5.0V	0.0V	-	ON	-	ON	ON	-	ON	-	-	2	-	ON	-	-	-	5.0	6.5	-	MHz
1M	Intermodulation	51	A SG.11	Variable	-	-	-	5.0V	0.0V	-	ON	-	ON	ON	-	ON	-	-	2	-	ON	-	-	-	30	35	-	dB
S/N	Video S/N	51A	A SG.2	-	-	-	-	5.0V	0.0V	-	ON	-	ON	ON	-	ON	-	-	2	-	ON	-	-	-	50	55	-	dB
V <sub>50H</sub>	AFT output maximum voltage	50	A SG.6	-	-	-	-	5.0V	0.0V	-	ON	-	ON	ON	-	ON	-	-	1	-	ON	-	-	-	8.3	8.7	-	V
V <sub>50L</sub>	AFT output minimum voltage	50	A SG.7	-	-	-	-	5.0V	0.0V	-	ON	-	ON	ON	-	ON	-	-	1	-	ON	-	-	-	-	0.3	0.7	V
μAFT	AFT sensitivity	50	A SG.5	-	-	-	-	5.0V	0.0V	-	ON	-	ON	ON	-	ON	-	-	1	-	ON	-	-	-	55	75	95	mV/ktHz
V <sub>50D1</sub>	AFT defeat voltage 1	50	-	-	-	-	-	5.0V	0.0V	-	ON	-	ON	ON	-	ON	-	-	1	-	ON	-	-	-	4.25	4.4	4.55	V
V <sub>50D2</sub>	AFT defeat voltage 2	50	A SG.14	-	-	-	-	5.0V	0.0V	-	ON	-	ON	ON	-	ON	-	-	1	-	ON	-	-	-	4.25	4.4	4.55	V
V <sub>50D3</sub>	AFT defeat voltage 3	50	A SG.1	-	-	-	-	5.0V	0.0V	-	ON	-	ON	ON	-	ON	-	-	2	-	ON	-	-	-	4.25	4.4	4.55	V

\*: "-" = OPEN

Symbol	Parameter	Test point	Input	Test conditions*																Limits			Unit					
				2A	5A	6A	48V	V <sub>CC</sub>	V <sub>CD</sub>	V <sub>CD</sub>	19S	2S	5S	10S	10S	12S	19S	48A	48S	49S	51S	52S		16S	Min.	Typ.	Max.	
V <sub>50M</sub>	AFT mute input level	A 50	A SG.1 variable	-	-	-	-	5.0V	0.0V	-	ON	-	ON	ON	ON	-	ON	-	1	-	ON	-	-	-	45	50	55	dBμ
V <sub>52H</sub>	RF AGC maximum voltage	52	A SG.2	-	2.0V	-	-	5.0V	0.0V	-	ON	-	ON	ON	ON	-	ON	-	2	-	ON	-	-	-	7.8	8.8	-	V
V <sub>52L</sub>	RF AGC minimum voltage	52	A SG.2	-	4.0V	-	-	5.0V	0.0V	-	ON	-	ON	ON	ON	-	ON	-	2	-	ON	-	-	-	-	0.1	0.3	V

\*: "-" = OPEN









NTSC SYSTEM SINGLE-CHIP COLOR TV SIGNAL PROCESSOR

**ELECTRICAL CHARACTERISTICS TEST METHOD**

**V<sub>o1</sub>** Video output DC voltage

Measure pin ⑤ output voltage when there is no input.

**V<sub>o1</sub>** Video detection output

1. Input SG. 1 (90dBμ).
2. Measure pin ⑤ output amplitude.

**V<sub>in min</sub>** Input sensitivity

1. Diminish SG. 3 input gradually, and read the input when the output amplitude is 3dB less than V<sub>o1</sub> (measured value).

**V<sub>in max</sub>** Maximum allowable input

1. Input SG. 4 (90dBμ).
2. Read the pin ⑤ output level (V<sub>A</sub>).
3. Increase SG. 4 input gradually, and read the input when pin ⑤ output is 3dB less than V<sub>A</sub>.

$$V_{in\ max} = 20 \log \frac{\text{Measured value}}{V_A} \text{ (dB)}$$

**BW** Video frequency characteristic

1. Input SG. 10, and adjust f<sub>2</sub> until pin ⑤ starts outputting 1MHz beat elements.
2. Raise the f<sub>2</sub> frequency, and read it when the f<sub>2</sub> frequency is 3dB less than the 1MHz elements.

$$BW = (\text{Frequency smaller than 1MHz element by 3dB}) - 58.75\text{MHz (MHz)}$$

**IM** Intermodulation

1. Input SG. 11, and apply voltage to pin ⑤ so that the pin ⑤ output will become as shown in the diagram.
2. Calculate the difference in the pin ⑤ output level between at 920kHz and at 3.58MHz.

$$IM = 20 \log \frac{920\text{kHz element}}{3.58\text{MHz}} \text{ (dB)}$$

**S/N** Video S/N

1. Input SG. 2, and measure the pin ⑤ output signal root-mean-square value.
2. Reference S/N

$$S/N = 20 \log \frac{V_{o1\ \text{measured value}} (V_{P-P}) \times 10^3 \times 0.7}{\text{Measured value (mVrms)}} \text{ (dB)}$$

**V<sub>50H</sub>** AFT output maximum voltage

**V<sub>50L</sub>** AFT output minimum voltage

**μAFT** AFT sensitivity

V<sub>50H</sub> and V<sub>50L</sub> are as shown below. The μAFT calculation formula is also given below.

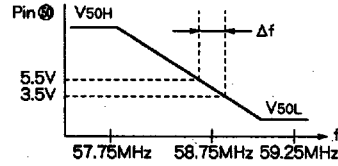

$$\text{Reference } \mu\text{AFT} = \frac{(5.5 - 3.5) \times 10^3 \text{mV}}{\Delta f \text{kHz}} \text{ (mV/kHz)}$$

**V<sub>5001</sub>, V<sub>5002</sub>, V<sub>5003</sub>** AFT defeat voltage 1, 2, 3

Make sure that the pin ⑤ output is 4.4V under the following conditions: no signal, f<sub>o</sub> minus 2.5MHz, f<sub>o</sub> plus 1MHz, and defeat SW.

**V<sub>50M</sub>** AFT mute input level

1. Input SG. 1 (80dBμ), and reduce the input gradually.
2. Read the input when the pin ⑤ voltage reaches the "center" (4.4V).

**V<sub>52H</sub>** RF AGC maximum voltage

1. Input SG. 11, and apply 2.0V to pin ⑥.
2. Measure pin ⑥ voltage.

**V<sub>52L</sub>** RF AGC minimum voltage

1. Input SG. 10, and apply 4.0V to pin ⑥.
2. Measure pin ⑥ voltage.

**LIM** Limiting sensitivity

Decrease SG. 19 input gradually, and read it at test point 3 when the 400Hz element is 3dB less than AF direct signal voltage V<sub>oAF</sub> (parameter S2).

**AMR**

Measure the 400Hz element at test point 3. The reading is called V<sub>am</sub>.

The reference AMR value can be calculated as follows:

$$AMR = 20 \log \frac{V_{oAF} \text{ (mVrms)}}{V_{am} \text{ (mVrms)}} \text{ (dB)}$$

**ATT** Maximum attenuation

1. Measure the 400Hz at pin ④ output.
2. The reference ATT value can be calculated as follows:

$$ATT = 20 \log \frac{V_{o4max}}{\text{Measured value}} \text{ (dB)}$$



NTSC SYSTEM SINGLE-CHIP COLOR TV SIGNAL PROCESSOR

**GAF** AF driver gain

Can be calculated as follows :

$$GAF = 20 \log \frac{V_{O4max}}{V_{OAF}} \text{ (dB)}$$

**S/NAF** Sound S/N

1. Measure pin④ output noise in a frequency range between 20Hz and 100Hz.
2. Sound S/N can be calculated as follows :

$$S/NAF = 20 \log \frac{V_{O4max}}{\text{Measured value}} \text{ (dB)}$$

**STH** Sound switching threshold voltage

Input SG. 17, and measure pin④ output when AVSW is set to EXT (2A = 1.1V).

**Iss** Sync separation input sensitivity current

Increase rated current supply Iss, and read the amperage when pin② output horizontal frequency is "pulled in" from the free-run frequency.

**V12min** Horizontal oscillation starting voltage

Apply voltage of approximately 3V to pin②, and increase it gradually. Read the voltage when pin② starts generating horizontal oscillation waveform. (Approx. 15kHz).

**fPHL** Horizontal pull-in range 1

**fPHH** Horizontal pull-in range 2

1. Reduce input signal SG. B frequency for input waveform and pin② output waveform to become unsynchronous.
2. Increase input frequency, and measure it at the moment when input waveform and pin② output waveform become synchronous. This lower pull-in frequency is called fPHL.
3. Measure the upper pull-in frequency by the same procedure (fPHH).
4. Calculate the difference between the measured values and reference value (15.734kHz).

**V20H** Horizontal output maximum voltage

**V20L** Horizontal output maximum voltage

**TH** Horizontal output pulse width

V20H, V20L and TH are as indicated below :

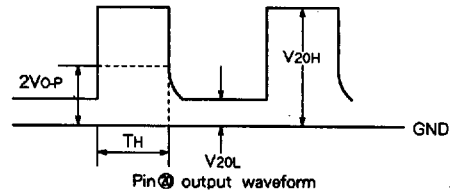

**VPRO** Overvoltage detection operating voltage

Increase voltage input to pin③ gradually. Read the voltage when the pin② output waveform becomes as shown below :

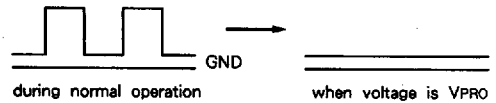

"Open" voltage input to pin③, and check that the condition as shown above is maintained.

**fV60** Vertical pull-in range

1. Raise input signal SG. E frequency for the input signal and pin② output waveform to become unsynchronous.
2. Decrease the input frequency gradually, and read the frequency when input signal and pin② output waveform become synchronous.

**V18H** Vertical output maximum voltage

**V18L** Vertical output minimum voltage

**Tv60** Vertical output pulse width

V18H, V18L and Tv60 are as indicated below.

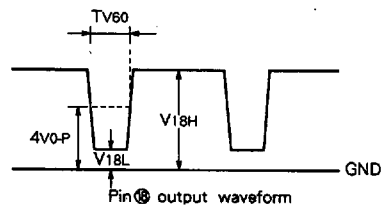

**Ymax** Maximum output

Input SG. F, and measure pin② output amplitude.



**GY** Reference gain

1. Input SG. G, and measure pin② output amplitude.
2. GY can be calculated as follows :

$$GY = 20 \log \frac{\text{Measured value (mVP-P)}}{200\text{mVP-P}} \text{ (dB)}$$

NTSC SYSTEM SINGLE-CHIP COLOR TV SIGNAL PROCESSOR

**GYmin, GYmax** Contrast control characteristics 1, 2

1. Input SG. G, and measure pin ② output amplitudes. The readings are called, respectively, VA and Vb.

$$2. GY_{min} = 20 \log \frac{V_A(mVP-P)}{\text{Measured GY value (mVP-P)}} \text{ (dB)}$$

$$GY_{max} = 20 \log \frac{V_A(mVP-P)}{\text{Measured GY value (mVP-P)}} \text{ (dB)}$$

**VBnorm, VBRTL, VBTRH** Brightness control characteristics

Input SG. A, and measure the difference as indicated below.

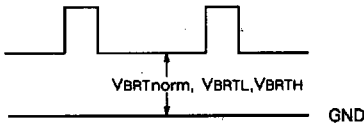

**GP** Peaking gain

1. Input SG. H, and measure pin ② output voltage (VA).  
Input SG. J, and measure pin ② output signal voltage (VB).
2. Peaking gain can be calculated as follows :

$$GP = 20 \log \frac{V_A(mVP-P)}{V_B(mVP-P)} \text{ (dB)}$$

**Gnorm, Gmin, Gmax** Video tone control characteristics

1, 2, 3

1. Measure pin ② output signal voltage when input to pin ④ is 4.5V, 9.0V and 0V. The measurements are called, respectively, VA, VB and VC.

$$2. G_{min} = 20 \log \frac{V_B}{V_A} \text{ (dB)}, G_{max} = 20 \log \frac{V_C}{V_A} \text{ (dB)}$$

Gnorm(dB) is expressed with the difference between the VB measured value as in this test and another VB value measured for calculation of GP as described above (Y9).

**f0[Y]** Frequency characteristic

Measure SG. K frequency at which pin ② output voltage is 3dB less than the VA measured value for calculation of GP as described above (Y9).

**VBLKV** Vertical blanking voltage

**VBLKTV** Vertical blanking width

1. VBLKV and VBLKTV are as shown below.

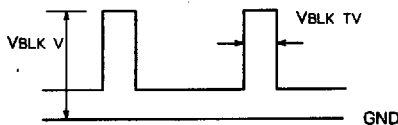

**VBLKH** Horizontal blanking threshold voltage

Increase voltage input to pin ② gradually, and read the pin ② potential when pin ⑤A comes to output no signal.

**YDL1, YDL2** Y delay 1, 2

Input SG. T to F. Measure pin ② output waveform delay with reference to input.

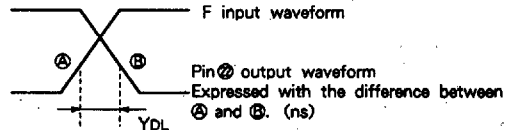
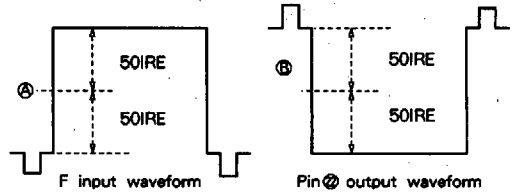

**BS** Black expansion threshold voltage

1. Set SG. U to 200kHz, V1 to 0.35V, and V2 to 0V. Input from "F." The difference between pedestal and white peak is 100IRE
2. Decrease V2 gradually, starting from approximately 75IRE. Read the point at which black expansion becomes available.

**AVTH** AWSW switching threshold voltage

1. Input SG. G to "H."
2. Apply 2.1V to pin ②A, and make sure that a waveform is being output from pin ④.
3. Apply 1.0V to pin ②A, and make sure that no waveform is being output from pin ④.

**AVTV** AVSW TV output signal voltage

**AVEXT** AVSW EXT output signal voltage

Input SG. W(-6dB) to "H" and "G," and measure pin ④ output waveform amplitude when input to pin ②A is set to OPEN and to GND.

**ACC-1, ACC-2** ACC characteristics 1, 2

1. Measure pin ⑤A output signal voltage when SG. L input is 0dB, -20dB and +6dB. The measurements are called, respectively, VA, VB and VC.

2. ACC-1, ACC-2 can be calculated as follows :

$$ACC-1 = 20 \log \frac{V_B}{V_A} \text{ (dB)}$$

$$ACC-2 = 20 \log \frac{V_C}{V_A} \text{ (dB)}$$

**Vik** Killer operation input level

Decrease SG. L input level, and read the input when pin ② DC voltage reaches the LOW level.

NTSC SYSTEM SINGLE-CHIP COLOR TV SIGNAL PROCESSOR

**Vok** Remaining color after killer operation

Input SG. Q, and measure pin (25A) output signal voltage.

**Cnorm** Chroma reference output

Input SG. L, and measure pin (25A) output signal voltage when input to pin (8) is 5.1V.

**Csmin, Csmax** Color control characteristics 1, 2

1. Read pin (25A) output signal voltage when input to pin (2) is 0V and 9.0V. The readings are called, respectively, VA and VB.

2. Csmin, Csmax is calculated as follows :

$$Csmin = 20 \log \frac{VA}{\text{Measured } Cnorm \text{ value}} \text{ (dB)}$$

$$Csmax = 20 \log \frac{VB}{\text{Measured } Cnorm \text{ value}} \text{ (dB)}$$

**Cemin, Cemax** Color tracking characteristics 1, 2

1. Measure pin (25) output signal voltage when input to pin (2) is 3.0V and 9.0V. The measurements are called, respectively, VA and VB.

2. Cumin, Cemax can be calculated as follows :

$$Cumin = 20 \log \frac{VA}{\text{Measured } Cnorm \text{ value}} \text{ (dB)}$$

$$Cumax = 20 \log \frac{VB}{\text{Measured } Cnorm \text{ value}} \text{ (dB)}$$

**fpcl, fpch** APC pull-in range 1, 2

1. Input SG. M, and decrease burst frequency and chroma frequency (fsb = fsc) adequately until "pull-in" comes off.
2. Increase frequency gradually, and measure input frequency when "pull-in" comes on.
3. Measure the upper "pull-in" frequency by the same procedure.
4. The reference frequency is the difference from the standard value (3.579545MHz).

**fpct** Total APC pull-in range

Calculated as follows : fpct = |fpcl| + fpch(kHz)

**CLb-y, CLr-y, CLg-y** Demodulating output carrier leak 1, 2, 3

1. Input SG. L (0dB).
2. Apply 4.6V and 5.1V to pins (2) and (8), and measure pin (23), (24) and (25) output carrier leak.

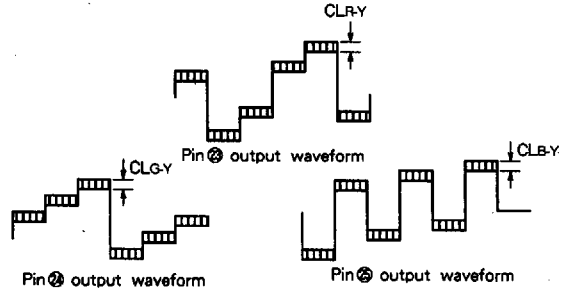

**SSY** Service switch operation 1

Input SG. G to "F," and turn S36 on. Measure the amplitude during a pin (25) output signal scanning period.

**SSC** Service switch operation 2

Input SG. L to "E," and turn S36 on. Measure pin (25A) output signal amplitude.

**SSV** Service switch operation 3

Measure pin (25) output signal maximum value when S36 is on.

**R-Y-N**  $\frac{G-Y}{B-Y} - N$  Demodulation ratio 1, 2

1. Input SG. L, and measure pin (23A), (24A) and (25A) output voltage.

2. The ratios can be calculated as follows, respectively :

$$\left( \frac{R-Y}{B-Y} - N \right) = \frac{\text{Pin (23A) output signal voltage}}{\text{Pin (25A) output signal voltage}}$$

$$\left( \frac{G-Y}{B-Y} - N \right) = \frac{\text{Pin (24A) output signal voltage}}{\text{Pin (25A) output signal voltage}}$$

$\angle R-Y-N, \angle G-Y-N$  Demodulation angle 1, 2

Using the B-Y output pin (25A) phase as reference, measure phase difference between R-Y output pin (23A) and G-Y output (pin (24A)).

**Continued**

Note 1. Adjust the variable resistor of one-shot multivibrator so that horizontal blanking pulse timing and pulse width will be as shown below :

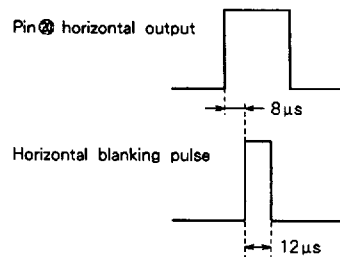

Determine 8µs with TTL IC M74LS221P pin (16) variable resistor. Also determine 12µs with pin (7) adjustable resistor.

## NTSC SYSTEM SINGLE-CHIP COLOR TV SIGNAL PROCESSOR

## Note 2. Coil adjustment

## § VCO coil

1. Set measuring conditions as previously described for V14.
2. Input continuous waves ( $F_o = 45.75\text{MHz}$ ,  $V_i = 90\text{dB}\mu$ ) from input pin A, and set S49 to 1.
3. Adjust VCO coil so that AFT OUT (pin ⑨) DC will become a half of  $V_{cc}$  (4.5V).

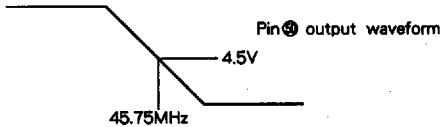

## § SIF coil

Set measuring conditions as previously described for S5, and adjust SIF coil for output waveform to be maximum and for distortion to be minimum.

## Note 3. Remarks for video-related item measurement

When measuring video-related items (Y1-Y23), be sure to satisfy the conditions listed below :

1. Set signal SG. A to "D."
2. Set switches S2B, S5, S10, S12, S13, S16, S20, S22 and S44 to ON.
3. Set other switches to OPEN unless otherwise noted.

## Note 4. Remarks for chroma-related item measurement

When measuring chroma-related items (C1-C32), be sure to satisfy the conditions listed below :

1. Set signal SG. A to input "D."
2. Set switches S2B, S5, S10, S12, S13, S14, S16, S20, S22 and S44 to ON. Set S34 to 2.
3. Set other switches to OPEN unless otherwise noted.

NTSC SYSTEM SINGLE-CHIP COLOR TV SIGNAL PROCESSOR

INPUT SIGNAL

SG. No.	Signal details (Terminal resistance : 50Ω)
SG. 1	$f_0 = 45.75\text{MHz}$ , 90dBμ, $f_m = 20\text{kHz}$ , AM77.8%
SG. 2	$f_0 = 45.75\text{MHz}$ , 80dBμ, CW
SG. 3	$f_0 = 45.75\text{MHz}$ , CW, Level variable
SG. 4	$f_0 = 45.75\text{MHz}$ , $f_m = 20\text{kHz}$ , AM16%, Level variable
SG. 5	$f_0 = 45.75\text{MHz}$ , $\pm 5\text{MHz}$ , 80dBμ, sweep signal
SG. 6	$f_0 = 45.75\text{MHz}$ , 80dBμ, CW
SG. 7	$f_0 = 46.2\text{MHz}$ , 80dBμ, CW
SG. 8	$f_0 = 41.25\text{MHz}$ , 110dBμ, CW
SG. 9	$f_0 = 41.25\text{MHz}$ , 70dBμ, CW
SG. 10	$f_1 = 45.75\text{MHz}$ , 90dBμ, CW } Mixed signal $f_2 = 44 \pm 5\text{MHz}$ , 70dBμ, CW }
SG. 11	$f_1 = 45.75\text{MHz}$ , 90dBμ, CW } Mixed signal $f_2 = 42.17\text{MHz}$ , 80dBμ, CW } $f_3 = 41.25\text{MHz}$ , 80dBμ, CW }
SG. 12	$f_0 = 45.75\text{MHz}$ , 110dBμ, CW
SG. 13	$f_0 = 45.75\text{MHz}$ , 60dBμ, CW
SG. 14	$f_0 = 45.75\text{MHz}$ , $-2.5\text{MHz}$ , $f_0 = 45.75 + 1\text{MHz}$ , 80dBμ, CW
SG. 16	$f_0 = 45.75\text{MHz}$ , 90dBμ, CW } Mixed signal $f_0 = 41.25\text{MHz}$ , 70dBμ, CW }
SG. 17	$f_0 = 4.5\text{MHz}$ , 83dBμ, $f_m = 400\text{Hz}$ , FM $\pm 25\text{kHz}$ dev
SG. 19	$f_0 = 4.5\text{MHz}$ , 83dBμ, $f_m = 400\text{Hz}$ , FM $\pm 25\text{kHz}$ Level variable
SG. 20	$f_0 = 4.5\text{MHz}$ , 83dBμ, $f_m = 400\text{Hz}$ , AM30%
SG. 21	$f_0 = 4.5\text{MHz}$ , 83dBμ, CW
SG. 23	$f_0 = 400\text{Hz}$ , 1VP-P, CW
SG. 24	$f_0 = 45.75\text{MHz}$ , 90dBμ, CW
SG. 25	$f_0 = 45.75\text{MHz}$ , 84dBμ, CW
SG. 26	$f_0 = 1\text{kHz}$ , 20mVP-P, CW
SG. 28	$f_0 = 45.75\text{MHz}$ , 45dBμ, CW
SG. A	<p>Sync separation input : NTSC standard video signal (APL100%) as shown in the illustration. Vertical input is interlaced at 60Hz.</p>
SG. B	<p>Horizontal sync signal : Duty 92%. Input level and frequency is variable.</p>
SG. C	$f = 2\text{kHz}$ , 100mVP-P, CW
SG. D	<p>Varies SG. A vertical sync signal width. START position is the same.</p>
SG. E	<p>Vertical sync signal : Duty 92%. Input level and frequency is variable.</p>

SG. No.	Signal details (Terminal resistance : 50Ω)
SG. F	$f = 200\text{kHz}$ , 2VP-P, CW
SG. G	$f = 200\text{kHz}$ , 200mVP-P, CW
SG. H	$f = 200\text{kHz}$ , 50mVP-P, CW
SG. J	$f = 3.58\text{MHz}$ , 200mVP-P, CW
SG. K	$f = 2\text{MHz} \sim 10\text{MHz}$ , Variable 200mVP-P, CW
SG. L	<p> <math>f_{ss}</math> : Burst signal frequency  <math>f_{sc}</math> : Chroma signal frequency  <math>f_{sb} = f_{sc} = 3.579545\text{MHz}</math>                      0dB : <math>e_b = 100\text{mVP-P}</math>  <math>e_c = 200\text{mVP-P}</math> </p>
SG. M	Basically the same as SG. L NTSC simple macro signals, except that burst signals and macro signals are in phase, and that the frequency is adjustable.
SG. N	$f = 3.57\text{MHz}$ , CW, Level variable
SG. Q	Basically the same as SG. L NTSC simple macro signals, except that burst signal "eb" is 0mVP-P and that macro signal amplitude "ec" is 200mVP-P.
SG. R	$f = 4.58\text{MHz}$ , CW, 0.2VP-P
SG. P	$f = 3.68\text{MHz}$ , CW, Level variable
SG. S	<p>DUTY 50%</p>
SG. T	<p>NTSC video signal with variable automatic phase control. Vertical signals should be interlaced at 50Hz.</p>
SG. U	<p><math>f = 200\text{kHz}</math>, CW  <math>V_1, V_2</math> variable</p>



**NTSC SYSTEM SINGLE-CHIP COLOR TV SIGNAL PROCESSOR**

**TYPICAL CHARACTERISTICS**

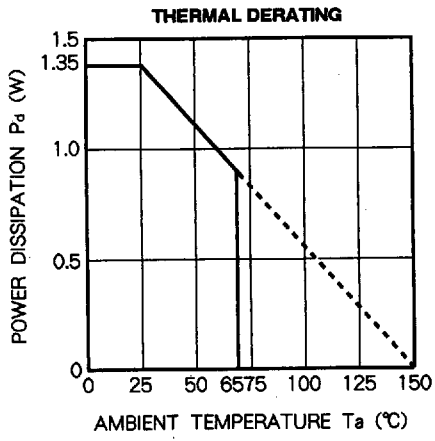

NTSC SYSTEM SINGLE-CHIP COLOR TV SIGNAL PROCESSOR

APPLICATION EXAMPLE

