

I²C Bus-Compatible Audio/Video Switch

Description

The CXA1845Q is a 7-input, 3-output audio/video switch featuring I²C bus compatibility for TVs.

Features

- Serial control via I²C bus
- 7 inputs, 3 outputs
- 3 outputs can each be independently selected
- Separate control of video and audio switches
- 6dB amplifiers for both video and audio outputs
- Wideband video amplifier (20MHz, -3dB)
- Y/C mixer circuit
- Slave address can be changed (90H/92H)
- Audio muting from external pin
- I²C bus line (SDA, SCL) is left in high impedance state when power is OFF
- Wide audio dynamic range (3Vrms typ.)

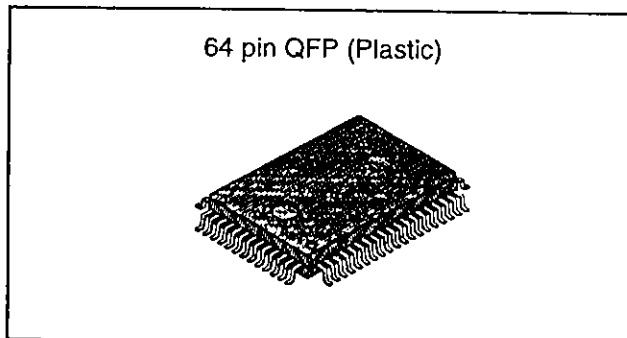

Absolute Maximum Ratings

| | | | |
|-------------------------------|------------------|-------------|----|
| • Supply voltage | V _{cc} | 12 | V |
| • Operating temperature | T _{opr} | -20 to +75 | °C |
| • Storage temperature | T _{stg} | -65 to +150 | °C |
| • Allowable power dissipation | P _d | 1000 | mW |

Operating Conditions

| | | | |
|----------------|-----------------|-------|---|
| Supply voltage | V _{cc} | 9±0.5 | V |
|----------------|-----------------|-------|---|

Structure

Bipolar silicon monolithic IC

Applications

Audio/video switch featuring I²C bus compatibility for TVs

Pin Configuration (Top View)

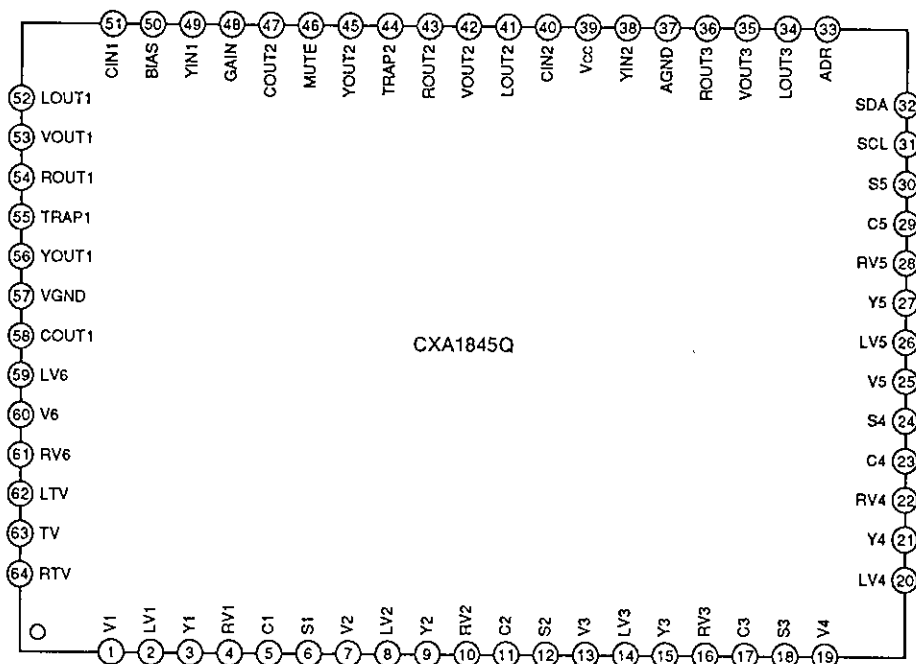

Sony reserves the right to change products and specifications without prior notice. This information does not convey any license by any implication or otherwise under any patents or other right. Application circuits shown, if any, are typical examples illustrating the operation of the devices. Sony cannot assume responsibility for any problems arising out of the use of these circuits.

Block Diagram

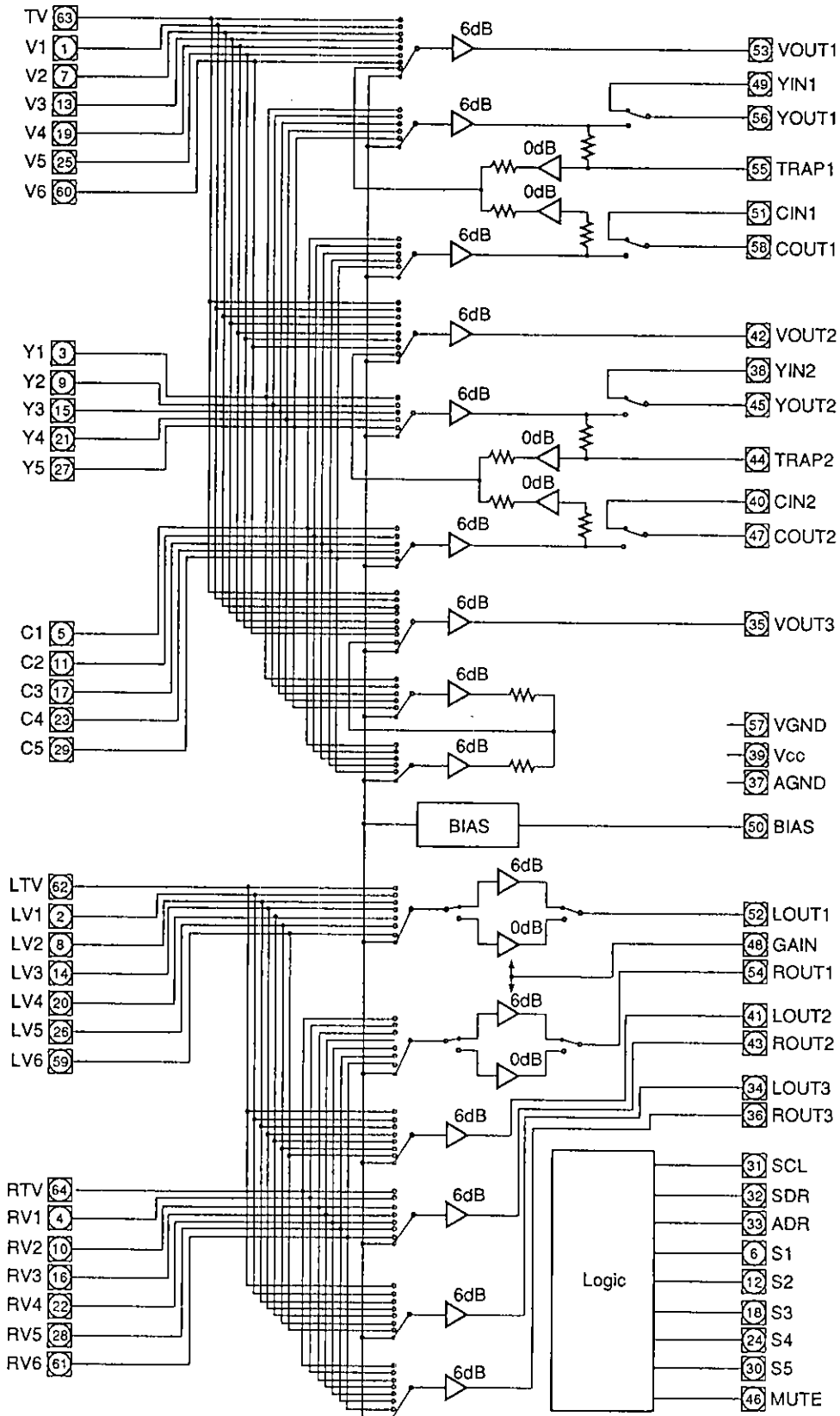

Note) A total gain of 0dB is achieved by connecting a 6kΩ resistor to the each audio input.

Pin Description

| Pin No. | Symbol | Pin voltage | Equivalent circuit | Description |
|---|--|-------------|--------------------|---|
| 63 1 7 13 19 25 60 | TV V1 V2 V3 V4 V5 V6 | 4.5V | | Video signal inputs. Input composite video signals. |
| 3 9 15 21 27 5 11 17 23 29 | Y1 Y2 Y3 Y4 Y5 C1 C2 C3 C4 C5 | 4.5V | | Y/C separation signal inputs Y1 to Y5 pins: Luminance signals input C1 to C5 pins: Chrominance signals input |
| 62 2 8 14 20 26 59 64 4 10 16 22 28 61 | LTV LV1 LV2 LV3 LV4 LV5 LV6 RTV RV1 RV2 RV3 RV4 RV5 RV6 | 4.6V | | Audio signal inputs. |
| 53 42 35 | VOUT1 VOUT2 VOUT3 | 4.5V | | Video signal outputs. Output composite video signals. |
| 56 45 58 47 | YOUT1 YOUT2 COUT1 COUT2 | 4.5V | | Y/C signal outputs. YOUT1, YOUT2 pins: Luminance signal output COUT1, COUT2 pins: Chrominance signal output |

| Pin No. | Symbol | Pin voltage | Equivalent circuit | Description |
|----------------------------------|--|-------------|--------------------|--|
| 49 38 51 40 | YIN1 YIN2 CIN1 CIN2 | 4.5V | | YIN1, CIN1 pins: Input the Y/C separated signal of VOUT1 output. YIN2, CIN2 pins: Input the Y/C separated signal of VOUT2 output. |
| 55 44 | TRAP1 TRAP2 | 4.5V | | Connect the subcarrier trap circuits. |
| 52 41 34 54 43 36 | LOUT1 LOUT2 LOUT3 ROUT1 ROUT2 ROUT3 | 4.6V | | Audio signal outputs. ZOUT = 50 Ω (Within DC ±2mA) |
| 50 | BIAS | 4.6V | | Internal reference bias (Vcc/2). A capacitor is connected between this pin and GND. |
| 31 | SCL | — | | I ² C bus signal input. V _{IL} = 1.5V (max.) V _{IH} = 3.0V (min.) |

| Pin No. | Symbol | Pin voltage | Equivalent circuit | Description |
|---------------------------|----------------------------|-------------|--------------------|---|
| 32 | SDA | — | | <p>I²C bus signal input/output. $V_{IL} = 1.5V$ (max.) $V_{IH} = 3.0V$ (min.) $V_{OL} = 0.4V$ (max.)</p> |
| 33 | ADR | — | | <p>Selects the slave address for the I²C bus. 90H at 1.5V or less 92H at 2.5V or more 90H when open</p> |
| 46 | MUTE | — | | <p>Audio output mute. Mute OFF at 1.5V or less Mute ON at 2.5V or more Mute OFF when open</p> |
| 6 12 18 24 30 | S1 S2 S3 S4 S5 | — | | <p>Video/S signal selection. S signal output at 0.8V or less Video signal output at 1.4V or more S signal output when open</p> |
| 48 | GAIN | — | | <p>Audio output gain control. 0dB output at 2.0V or less -6dB output at 3.0V or more 0dB output when open</p> |

Electrical Characteristics

(Ta=25°C, Vcc=9V)

| Item | Symbol | Conditions | Min. | Typ. | Max. | Unit |
|---------------------|--------|----------------------------|------|------|------|------|
| Current consumption | icc | Vcc=9V, no signal, no load | 48 | 60 | 78 | mA |

(Video system)

| | | | | | | |
|--|-------|--|-----|-----|-----|------|
| Gain | GVv | f=100kHz, 0.3Vp-p input (Fig. 1) | 5.5 | 6.0 | 6.5 | dB |
| Frequency response characteristics | FBWV1 | 0.3Vp-p input, input frequency where output amplitude is -3dB with 100kHz output serving as 0dB (Fig. 1) | 15 | 20 | — | MHz |
| Frequency response characteristics (Y/C mix) | FBWV2 | 0.3Vp-p input, input frequency where output amplitude is -3dB with 100kHz output serving as 0dB (Fig. 1) | 10 | 15 | — | MHz |
| Input dynamic range | Vdv | f=100kHz, maximum with distortion<1.0% (Fig. 1) | 2.0 | — | — | Vp-p |
| Cross talk | Vctv | f=4.43MHz, 1Vp-p input (Fig. 2) | — | — | -50 | dB |

(Audio system)

| | | | | | | |
|------------------------------------|------|--|-----|------|------|------|
| Gain | GVA | f=1kHz, 1Vp-p input, 6kΩ resistor inserted to input (Fig. 3) | -1 | 0 | 1 | dB |
| Frequency response characteristics | FBWA | 1Vp-p input, input frequency where output amplitude is -3dB with 100kHz output serving as 0dB (Fig. 3) | 50 | — | — | kHz |
| Total harmonic distortion | THD | f=1kHz, 2.2Vp-p input, when 400Hz HPF + 80kHz LPF are inserted (Fig. 3) | — | 0.03 | 0.05 | % |
| Input dynamic range | VdA | f=1kHz, maximum with distortion<0.3% (Fig. 3) | 2.8 | 3.0 | — | Vrms |
| Cross talk | Vcta | f=1kHz, 1Vp-p input (Fig. 4) | — | -90 | -80 | dB |
| Ripple rejection ratio | | f=100Hz, 0.3Vp-p applied to Vcc (Fig. 5) | — | -50 | -40 | dB |
| Output DC offset | VOFF | Offset voltage between input and output (Fig. 6) | -30 | — | 30 | mV |
| Residual noise | VNA | fCL=300Hz, fCH=19kHz, 40dB amplifier connected (Fig. 7) | 0 | — | 6.0 | mV |
| S/N ratio | S/N | f=1kHz, 1Vrms input (Fig. 3) | 90 | 100 | — | dB |

(Logic system)

| Item | Symbol | Conditions | Min. | Typ. | Max. | Unit |
|--|----------------------|-------------------------------|------|------|------|------|
| High level input voltage | V _{IH} | | 3.0 | — | 5.0 | V |
| Low level input voltage | V _{IL} | | 0 | — | 1.5 | V |
| Low level output voltage | V _{OL} | With SDA 3mA current supplied | 0 | — | 0.4 | V |
| High level input current | I _{IH} | V _{IH} =4.5V | 0 | — | 10 | μA |
| Low level input current | I _{IL} | V _{IL} =0.4V | 0 | — | 10 | μA |
| Maximum clock frequency | f _{SCL} | | 0 | — | 100 | kHz |
| Minimum waiting time for data change | t _{BUF} | | 4.0 | — | — | μs |
| Minimum waiting time for data transfer start | t _{HD; STA} | | 4.0 | — | — | μs |
| Low level clock pulse width | t _{LOW} | | 4.7 | — | — | μs |
| High level clock pulse width | t _{HIGH} | | 4.0 | — | — | μs |
| Minimum waiting time for start preparation | t _{SU; STA} | | 4.7 | — | — | μs |
| Minimum data hold time | t _{HD; DAT} | | 120 | — | — | ns |
| Minimum data preparation time | t _{SU; DAT} | | 650 | — | — | ns |
| Rise time | t _R | | — | — | 1 | μs |
| Fall time | t _F | | — | — | 300 | ns |
| Minimum waiting time for stop preparation | t _{SU; STO} | | 4.7 | — | — | μs |

Electrical Characteristics Measurement Circuit

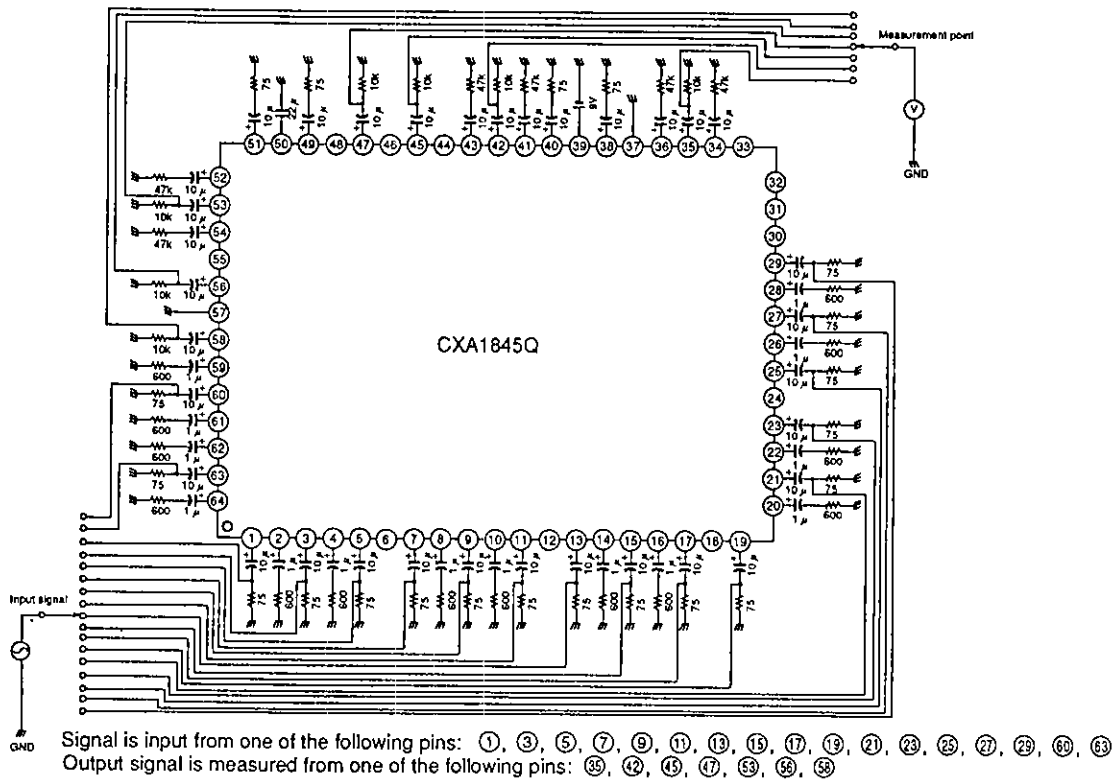

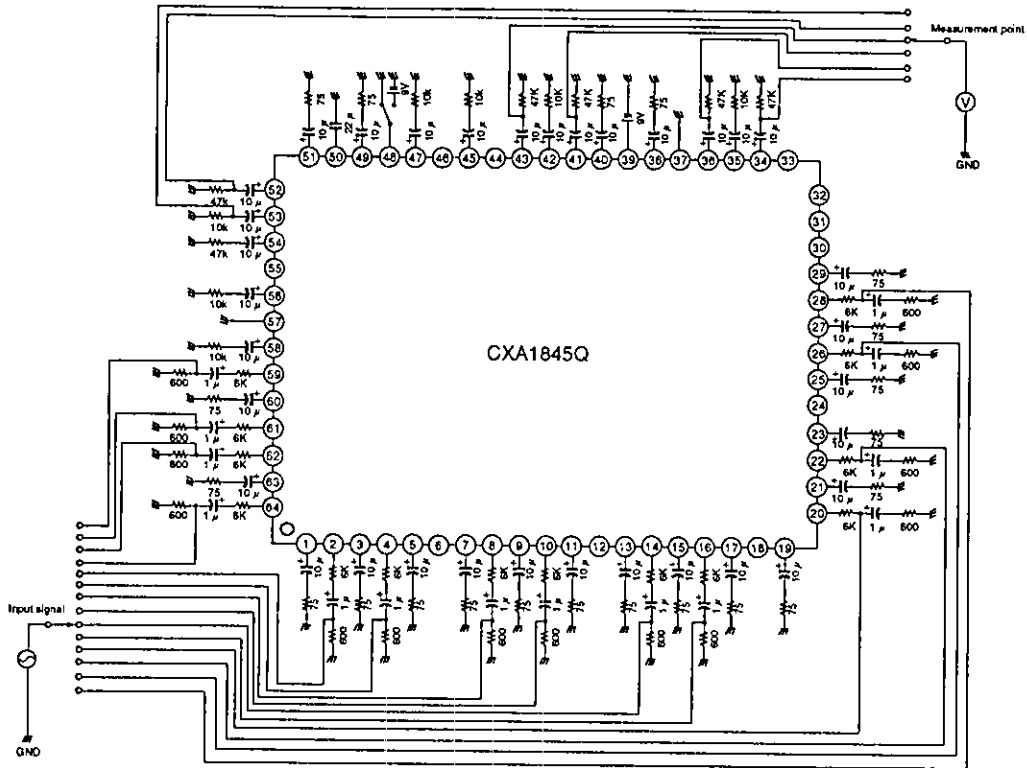

Signal is input from one of the following pins: ②, ④, ⑧, ⑩, ⑬, ⑮, ⑰, ⑲, ⑳, ㉒, ㉔, ㉖, ㉘, ㉙, ⑤①, ⑤②, ⑤④
 Output signal is measured from one of the following pins: ③③, ③⑤, ④①, ④③, ⑤②, ⑤④
 When 9V is applied to Pin ④③, the signals from Pins ③③ and ⑤④ can be measured for output gain of -6dB .

Fig. 3 Audio system (gain, frequency response characteristics, total harmonic distortion, input dynamic range)

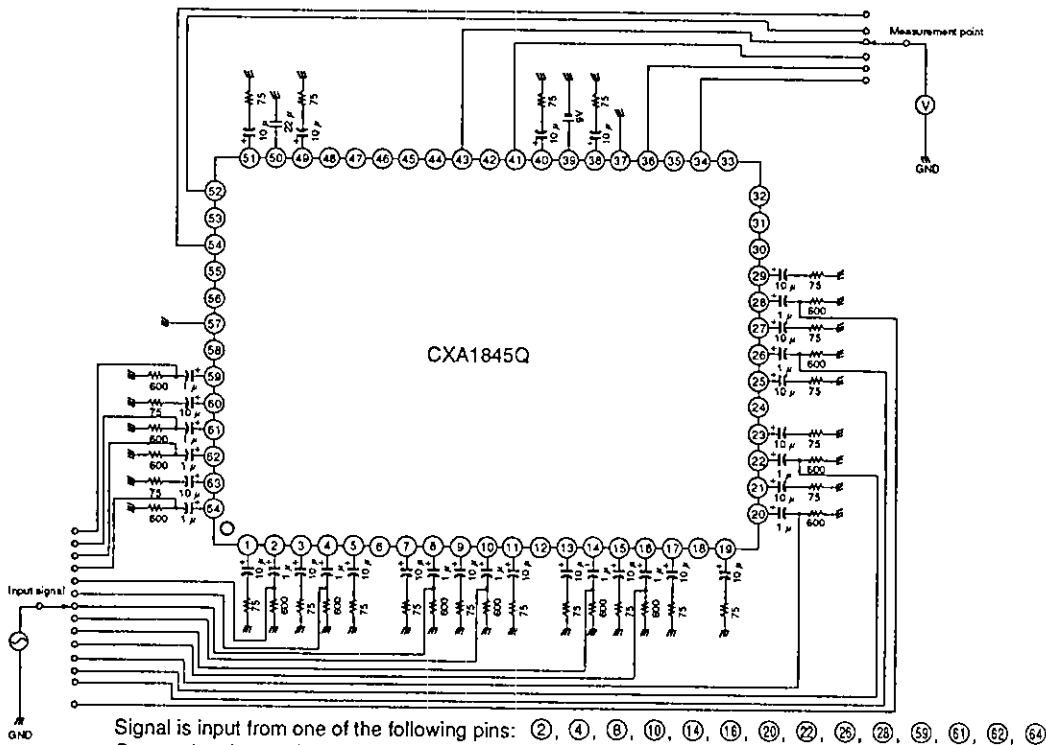

Signal is input from one of the following pins: ②, ④, ⑧, ⑩, ⑬, ⑮, ⑰, ⑲, ⑳, ㉒, ㉔, ㉖, ㉘, ㉙, ⑤①, ⑤②, ⑤④
 Output signal form pins other than outputs selected with the switch is measured.

Fig. 4 Audio system (cross talk)

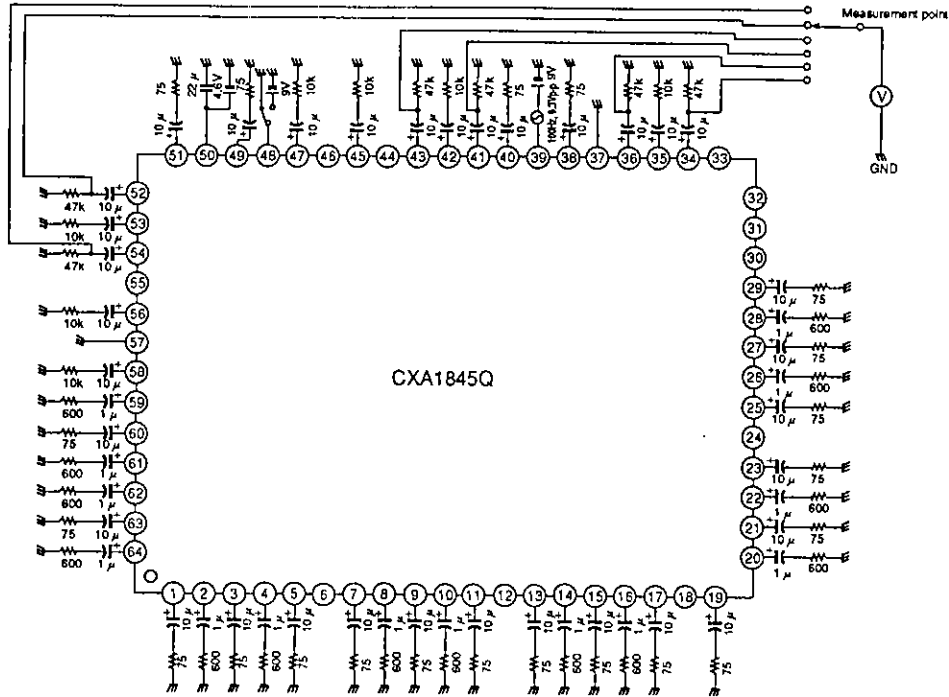

A $f=100\text{Hz}$, 0.3Vp-p signal is applied to Vcc and the output signals from Pins 34, 35, 41, 43, 52 and 54 are measured. When 9V is applied to Pin 46, the signals from Pins 32 and 34 can be measured for output gain of -6dB .

Fig. 5 Audio system (ripple rejection)

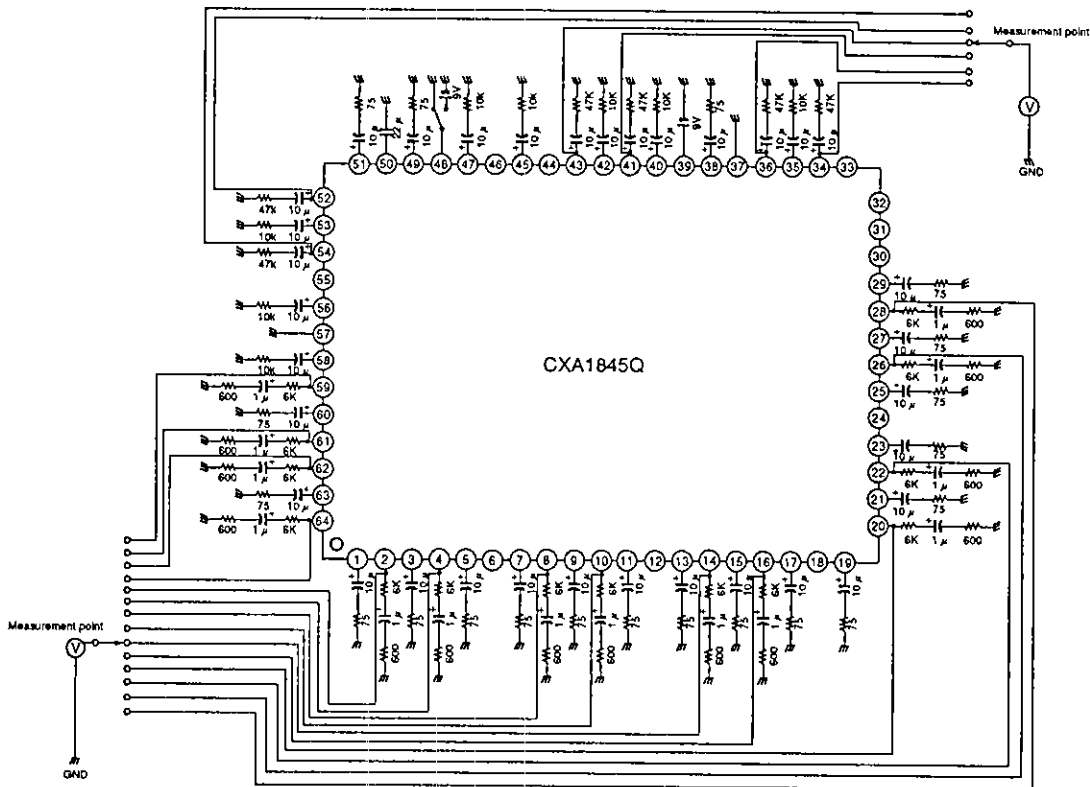

When 9V is applied to Pin 46, the signals from Pins 32 and 34 can be measured for output gain of -6dB .

Fig. 6 Audio system (output DC offset)

Application Circuit

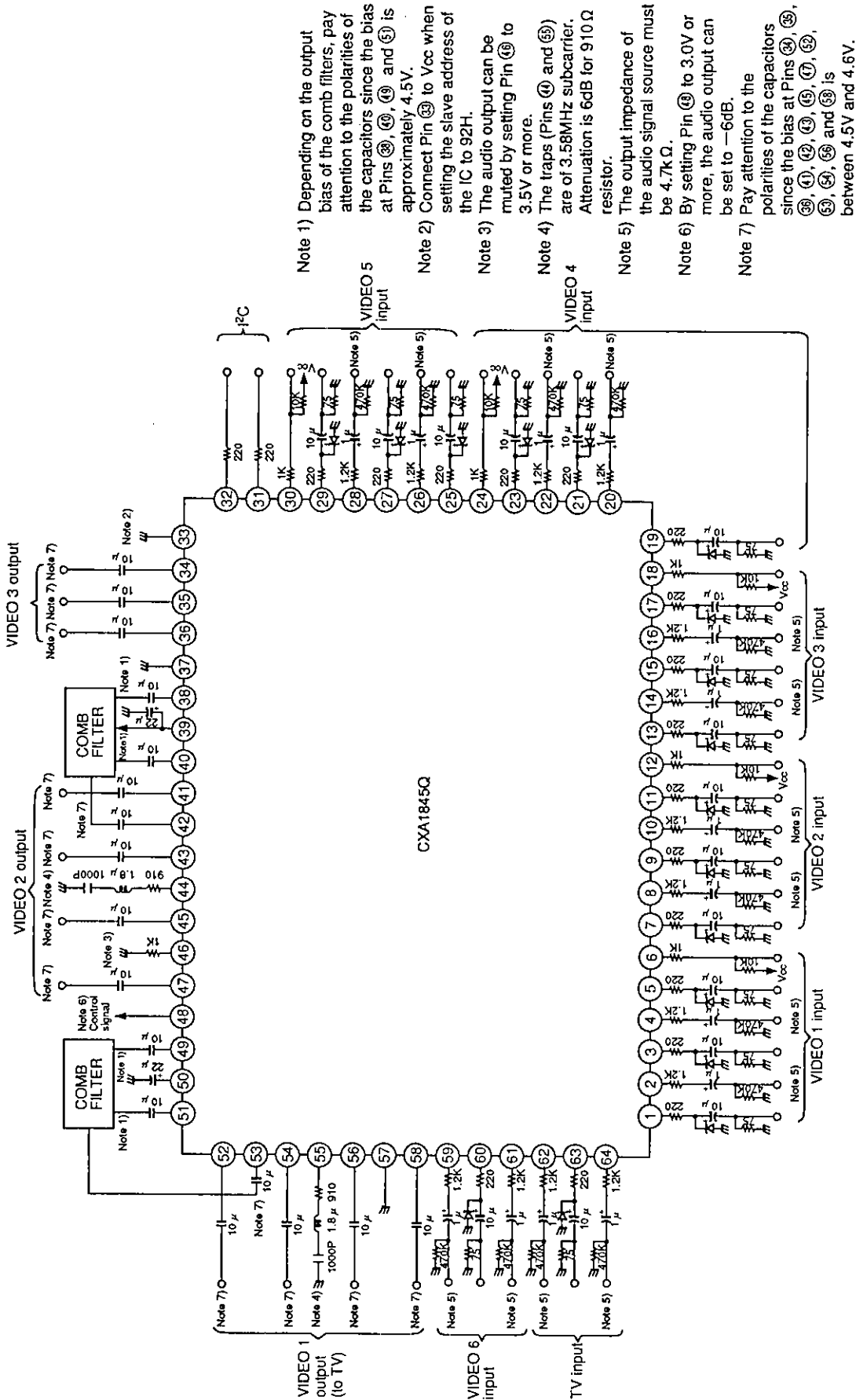

Application circuits shown are typical examples illustrating the operation of the devices. Sony cannot assume responsibility for any problems arising out of the use of these circuits or for any infringement of third party patent and other right due to same.

I²C Bus Control Signal

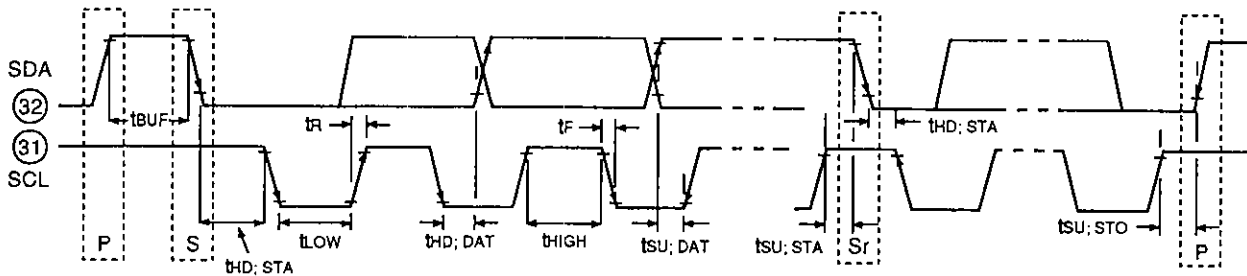

Fig. 7

Description of Operation

The CXA1845Q is a TV I²C bus-compatible AV switch IC. The video system and the stereo audio system both have 7 inputs and 3 outputs each. Each video output is provided with a built-in 6dB amplifier. Desired inputs can be independently assigned to all outputs (in the audio system, the left and right channels are processed as one unit) by I²C bus control.

I²C Bus Registers

① I²C Bus

The I²C bus (Inter-IC bus) is an inter-IC bus system developed by Phillips.

Two wires (SDA-serial data, SCL-serial clock) provide control over start, stop, data transfer, synchronization, and collision avoidance. The IC outputs are either open collector or open drain, forming a bus line in the wired OR format.

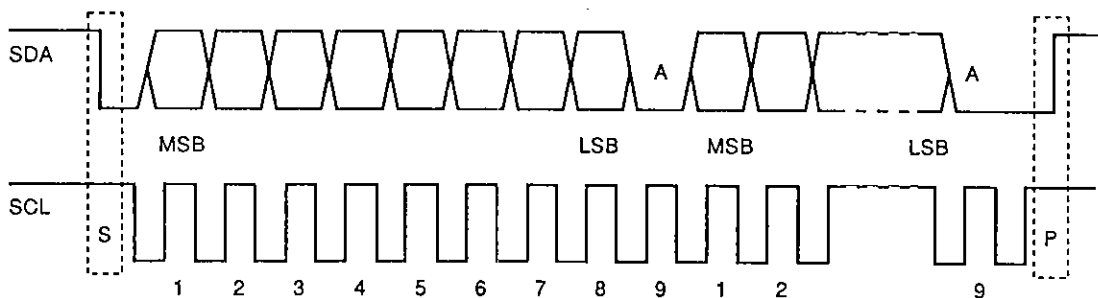

S: Start condition; SDA is set at "Low" when SCL is "High"
 P: Stop condition; SDA is set at "High" when SCL is "High"
 A: Acknowledge signal sent from the slave

Data is transmitted by MSB-first. One data unit consists of 8 bits, to which the acknowledge signal, which indicates that the data has been accepted by the slave, is attached at the end. Normally, the slave*¹ IC receives data at the rising edge of SCL and the master*² IC changes data at the falling edge of SCL.

- *1 Slave: An IC that is placed under the control of the master. In a normal system, all devices excluding the central microcomputer are slaves.
- *2 Master: A central microcomputer or other controlling IC.

② Control Registers

The CXA1845Q control is exercised by writing 3-byte data into the three 8-bit control registers which control the 3 outputs selector circuits.

| | | | | | | | | | |
|---|---------------|---|-------|---|-------|---|-------|---|---|
| S | Slave address | A | DATA1 | A | DATA2 | A | DATA3 | A | P |
|---|---------------|---|-------|---|-------|---|-------|---|---|

- S: Start condition
- A: Acknowledge
- P: Stop condition

• Slave address

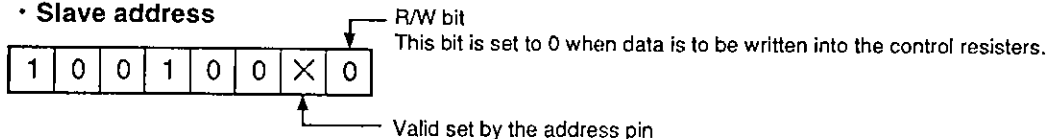

- DATA1 Provides video 1 output control
- DATA2 Provides video 2 output control
- DATA3 Provides video 3 output control

• Control register structure (DATA1 to DATA3)

| | | | | | | | |
|--------|----|-------|----|----|-------|----|----|
| b7 | b6 | b5 | b4 | b3 | b2 | b1 | b0 |
| S CONT | | VIDEO | | | AUDIO | | |
| (2) | | (3) | | | (3) | | |

Parentthesized numbers indicate the number of bits

Each register is set to 0 upon power ON.

Video switch control (VIDEO)

| b5 | b4 | b3 | Input signal selected |
|----|----|----|-----------------------|
| 0 | 0 | 0 | Mute |
| 0 | 0 | 1 | TV |
| 0 | 1 | 0 | V1 |
| 0 | 1 | 1 | V2 |
| 1 | 0 | 0 | V3 |
| 1 | 0 | 1 | V4 |
| 1 | 1 | 0 | V5 |
| 1 | 1 | 1 | V6 |

V1 system; V1, Y1, C1
 V2 system; V2, Y2, C2
 V3 system; V3, Y3, C3
 V4 system; V4, Y4, C4
 V5 system; V5, Y5, C5
 V6 system; V6

Audio switch control (AUDIO)

| b2 | b1 | b0 | Input signal selected |
|----|----|----|-----------------------|
| 0 | 0 | 0 | Mute |
| 0 | 0 | 1 | RTV/LTV |
| 0 | 1 | 0 | RV1/LV1 |
| 0 | 1 | 1 | RV2/LV2 |
| 1 | 0 | 0 | RV3/LV3 |
| 1 | 0 | 1 | RV4/LV4 |
| 1 | 1 | 0 | RV5/LV5 |
| 1 | 1 | 1 | RV6/LV6 |

S input control (S CONT)

| b7 | b6 | Output pin |
|----|----|--------------------------|
| 0 | X | Selected by S1 to 5 pins |
| 1 | 0 | Selects composite input. |
| 1 | 1 | Selects S input. |

Composite input: TV, V1 to V6
S input: Y1 to Y5, C1 to C5

Note 1) When "b7" is set to 0, the S input/composite input is automatically switched by the voltages at S1 to 5 pins.

Note 2) The YOUT1/2 and COUT1/2 switches are also switched by this control.
Low: S input
High: Composite input

③ Status Registers

| | | | | | | | |
|---|---------------|---|-------|---|-------|----|---|
| S | Slave address | A | DATA1 | A | DATA2 | NA | P |
|---|---------------|---|-------|---|-------|----|---|

| | | | | | |
|---|---------------|---|-------|----|---|
| S | Slave address | A | DATA1 | NA | P |
|---|---------------|---|-------|----|---|

- S: Start condition
- A: Acknowledge
- P: Stop condition
- NA: No acknowledge

When communication is to be terminated in the status register reading mode, the "no acknowledge" signal is needed to assure that the master does not issue the acknowledge signal to slave. Only DATA1 of status register can be read if NA is sent after DATA1.

• Slave address

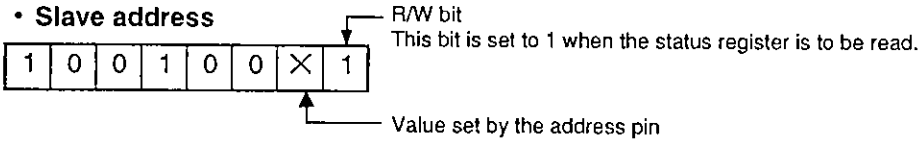

• DATA

| | b7 | | | b4 | b3 | b2 | b1 | b0 |
|-------|--------|---|---|------------|------------|------------|------------|------------|
| DATA1 | PONRES | X | X | S5 SEL | S4 SEL | S3 SEL | S2 SEL | S1 SEL |
| DATA2 | PONRES | X | X | S5 OPEN | S4 OPEN | S3 OPEN | S2 OPEN | S1 OPEN |

PONRES

When the CXA1845Q is reset upon power ON, logical 1 is returned. Once a read operation is completed, logical 0 is returned.

S1 to S5 OPEN

0: S1 to S5 pins are not open.

1: S1 to S5 pins are open.

S1 to S5 SEL

0: S1 to S5 pins are not grounded.

1: S1 to S5 pins are grounded.

In actually, the logic states of the S1 to S5 OPEN and the S1 to S3 SEL bits are determined by comparing the DC voltages of S1 to S5 pins to two threshold values.

| DC voltage of S1 to S5 pins | S1 to S5 OPEN | S1 to S5 SEL |
|------------------------------|---------------|--------------|
| 0.8 V or less | 0 | 1 |
| 1.3 V or more, 3.5 V or less | 0 | 0 |
| 4.5 V or more | 1 | 0 |

④ Power ON reset

The CXA1845Q incorporates the power ON reset function. Therefore, each control register is reset to 0 upon power ON.

The power ON reset V_{TH} is hysteretical. The PONRES bit of the status register is read to determine whether the IC is reset upon power ON.

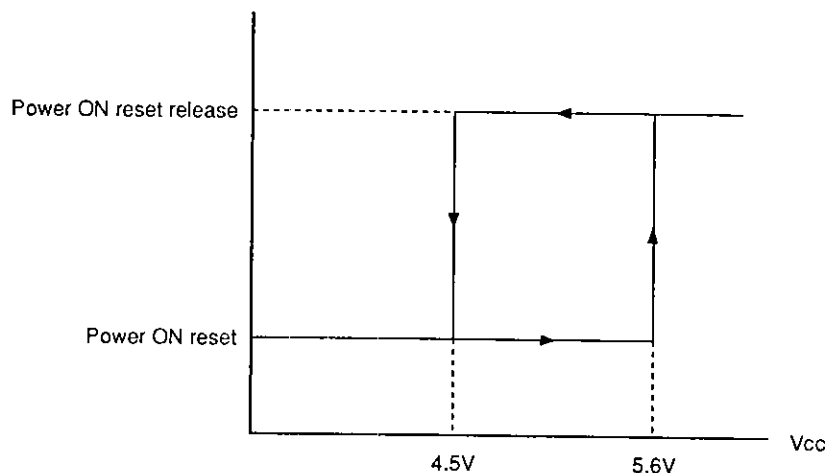

Example of Representative Characteristics

Video frequency response

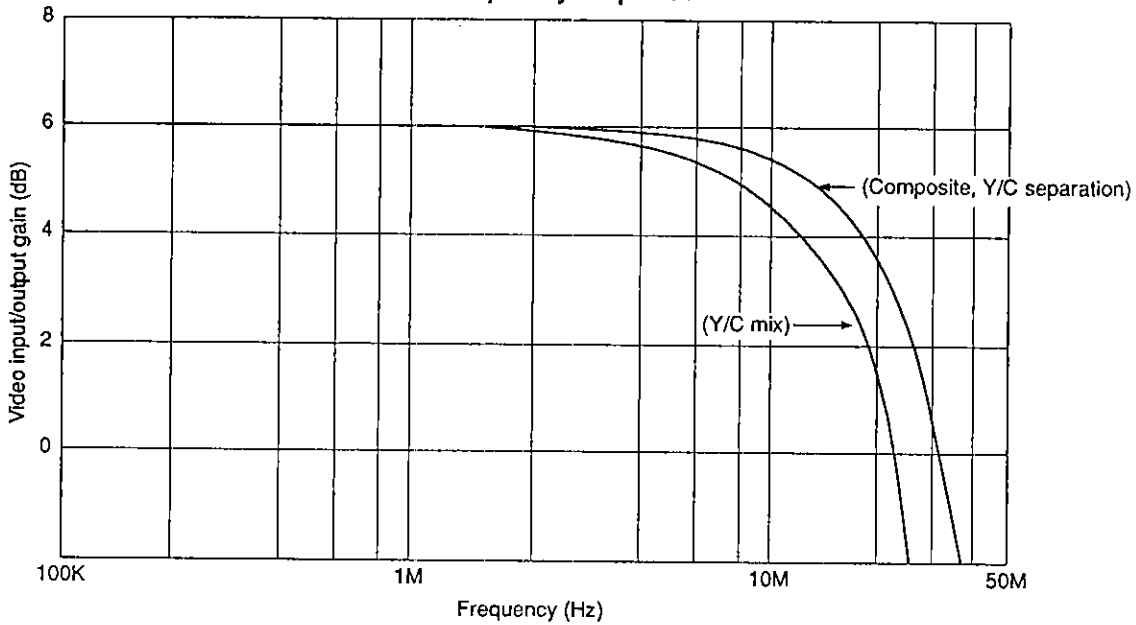

Audio frequency response

