

DUAL OPERATIONAL AMPLIFIERS

The KA1458 series is a dual general purpose operational amplifier. The KA1458 series is a short circuit protected and require no external components for frequency compensation. High common mode voltage range and absence of "latch up" make the KA1458 ideal for use as voltage followers. The high gain and wide range of operating voltage provides superior performance in intergrator, summing amplifier and general feedback applications.

FEATURES

- Internal frequency compensation
- Short circuit protection
- Large common mode and differential voltage range
- No latch up
- Low power consumption

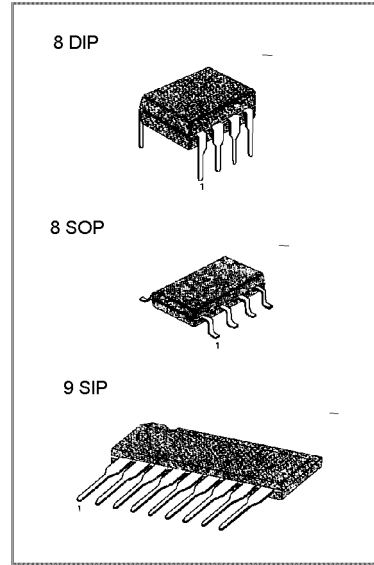

BLOCK DIAGRAM

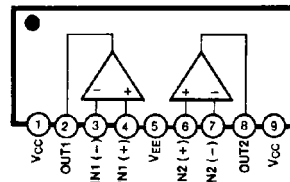
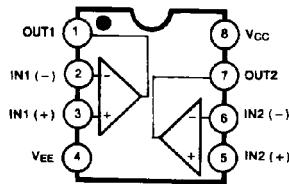

ORDERING INFORMATION

Device	Package	Operating Temperature
KA1458 KA1458A	8 DIP	0 ~ + 70°C
KA1458S KA1458AS	9 SIP	
KA1458D KA1458AD	8 SOP	
KA1458I KA1458AI	8 DIP	-25 ~ + 85°C
KA1458IS KA1458AIS	9 SIP	
KA1458ID KA1458AID	8 SOP	

SCHEMATIC DIAGRAM

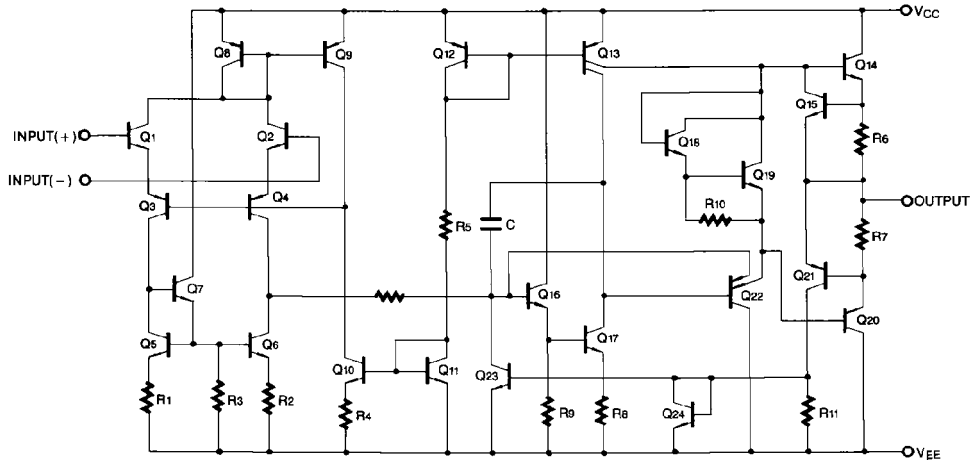

ABSOLUTE MAXIMUM RATINGS

Characteristic	Symbol	Value	Unit
Power Supply Voltage	V_{CC}	± 18	V
Input Differential Voltage	$V_{I(DIFF)}$	± 30	V
Input Voltage	V_I	± 15	V
Operating Temperature Range KA1458/Al	T_{OPR}	$-25 \sim +85$	$^{\circ}C$
KA1458/A		$0 \sim +70$	$^{\circ}C$
Storage Temperature Range	T_{STG}	$-65 \sim +150$	$^{\circ}C$

ELECTRICAL CHARACTERISTICS

($V_{CC} = +15V$, $V_{EE} = -15V$, $T_A = 25^\circ C$ unless otherwise specified)

Characteristic	Symbol	Test Conditions	KA1458A/AI			KA1458/I			Unit
			Min	Typ	Max	Min	Typ	Max	
Input Offset Voltage	V_{IO}	$R_S \leq 10K\Omega$		2.0	6.0		2.0	10	mV
Input Offset Current	I_{IO}			20	200		20	300	nA
Input Bias Current	I_{BIAS}			80	500		80	700	nA
Large Signal Voltage Gain	G_V	$V_{O(P,P)} = \pm 10V$, $R_L \geq 2.0K\Omega$	20	200		20	200		V/mV
Input Voltage Range	$V_{I(R)}$		± 12	± 13		± 11	± 13		V
Input Resistance	R_I		0.3	1.0		0.3	1.0		$M\Omega$
Common Mode Rejection Ratio	CMRR		70	90		60	90		dB
Power Supply Rejection Ratio	PSRR		77	90		77	90		dB
Supply Current (Both Amplifier)	I_{CC}			2.3			2.3	8.0	mA
Output Voltage Swing	$V_{O(P,P)}$	$R_S \leq 10K\Omega$	± 12	± 14	5.6	± 11	± 14		V
		$R_S \leq 10K\Omega$	± 10	± 13		± 9	± 13		
Output Short Circuit Current	I_{SC}			20			20		mA
Power Consumption	P_C	$V_O = 0V$		70	170		70	240	mW
Transient Response (Unity Gain)									
Rise Time	t_{RES}	$V_I = 20mV, R_L \geq 2K\Omega, C_L \leq 100pF$		0.3			0.3		μs
Overshoot	OS	$V_I = 20mV, R_L \geq 2K\Omega, C_L \leq 100pF$		15			15		%
Slew Rate	SR	$V_I = 10V, R_L \geq 2K\Omega, C_L \leq 100pF$		0.5			0.5		V/ μs

ELECTRICAL CHARACTERISTICS

($V_{CC} = +15V$, $V_{EE} = -15V$, NOTE 1, unless otherwise specified)

Characteristic	Symbol	Test Conditions	KA1458A/AI			KA1458/I			Unit
			Min	Typ	Max	Min	Typ	Max	
Input Offset Voltage	V_{IO}	$R_S \leq 10K\Omega$			7.5			12	mV
Input Offset Current	I_{IO}				300			400	nA
Input Bias Current	I_{BIAS}				800			1000	nA
Large Signal Voltage Gain	G_V	$V_{O(P,P)} = \pm 10V$, $R_L \leq 2.0K\Omega$	15			15			V/mV
Common Mode Rejection Ratio	CMRR	$R_S \geq 10K\Omega$	70	90		70	90		dB
Power Supply Rejection Ratio	PSRR	$R_S \geq 10K\Omega$	77	90		77	90		dB
Output Voltage Swing	$V_{O(P,P)}$	$R_L = 10K\Omega$	± 12	± 14		± 11	± 14		V
		$R_L = 2K\Omega$	± 10	± 13		± 9	± 13		
Input Voltage Range	$V_{I(R)}$		± 12			± 12			V

NOTE 1

KA1458/A : $0 \geq T_A \geq 70^\circ C$

KA1458/AI : $-25 \geq T_A \geq +85^\circ C$

TYPICAL PERFORMANCE CHARACTERISTICS

Fig. 1 OPEN-LOOP VOLTAGE GAIN vs POWER SUPPLY VOLTAGES

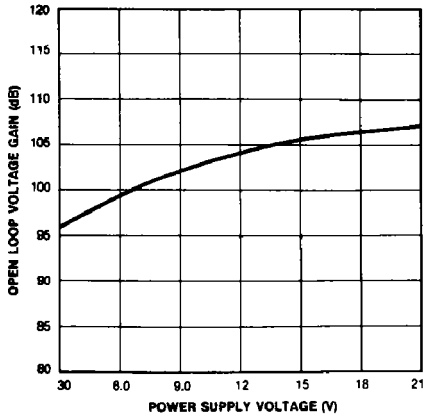

Fig. 2 OPEN-LOOP FREQUENCY RESPONSE

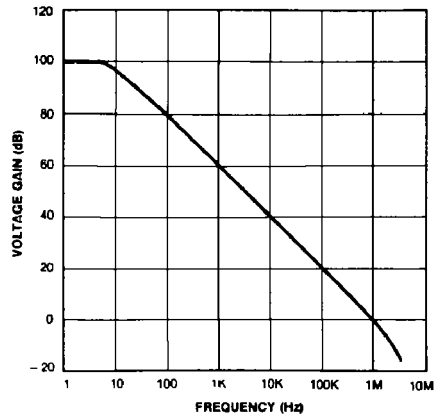

Fig. 3 POWER BANDWIDTH (LARGE SIGNAL SWING vs FREQUENCY)

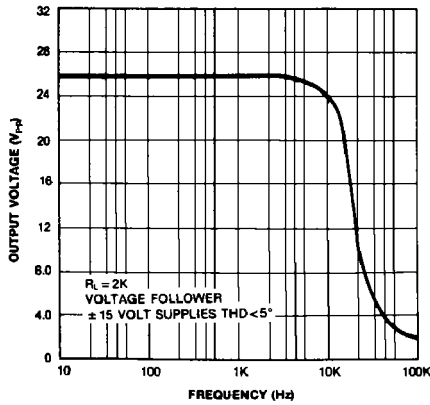
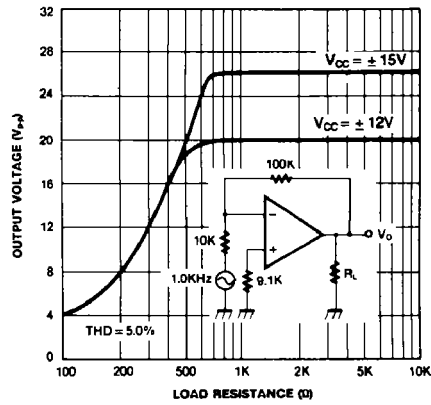

Fig. 4 OUTPUT VOLTAGE SWING vs LOAD RESISTANCE



Dimensions in Millimeters

