

6249826 MITSUBISHI ELEK (LINEAR)

80C 09208

D T-43-25

5-UNIT 500mA DARLINGTON TRANSISTOR ARRAY

DESCRIPTION

The M54521P, 5-channel sink driver, consists of 10 NPN transistors connected to form high current gain driver pairs.

FEATURES

- Output sustaining voltage to 30V
- High output sink current to 500mA
- Wide operating temperature range ($T_a = -20 \sim +75^\circ\text{C}$)

APPLICATION

Relay and printer drivers, LED or incandescent display digit driver, Interfacing for standard MOS/BIPOLAR logics

FUNCTION

The M54521P is comprised of five NPN darlington driver pairs. All emitters and the substrate are connected together to pin 7. The output are capable of sinking 500mA and will withstand 30V in the OFF state.

PIN CONFIGURATION (TOP VIEW)

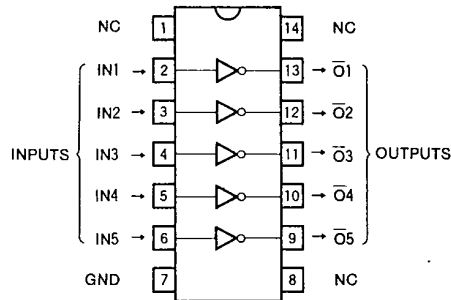

Outline 14P4

NC : NO CONNECTION

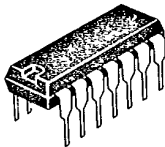

14-pin molded plastic DIP

CIRCUIT SCHEMATIC

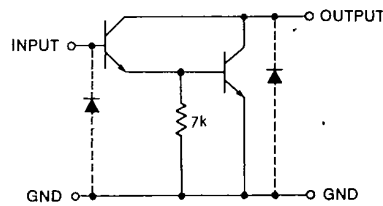

Unit : Ω

ABSOLUTE MAXIMUM RATINGS ($T_a = -20 \sim +75^\circ\text{C}$, unless otherwise noted)

Symbol	Parameter	Conditions	Ratings	Unit
V_{CEO}	Output sustaining voltage	Transistor OFF	-0.5 ~ +30	V
I_C	Collector current	Transistor ON	500	mA
P_d	Power dissipation	$T_a = 25^\circ\text{C}$	1.47	W
T_{opr}	Operating ambient temperature range		-20 ~ +75	$^\circ\text{C}$
T_{stg}	Storage temperature range		-55 ~ +125	$^\circ\text{C}$

5-UNIT 500mA DARLINGTON TRANSISTOR ARRAY

RECOMMENDED OPERATIONAL CONDITIONS (T_a = -20~+75°C, unless otherwise noted)

Symbol	Parameter		Limits			Unit
			Min	Typ	Max	
V _O	Output voltage		0		30	V
I _C	Collector current per channel	Percent duty cycle less than 10%	0		400	mA
		Percent duty cycle less than 55%	0		200	
I _{IH}	"H" Input current	I _C = 200mA	1		5	mA
		I _C = 400mA	2		5	
I _{IL}	"L" Input current			0		μA

ELECTRICAL CHARACTERISTICS (T_a = -20~+75°C, unless otherwise noted)

Symbol	Parameter	Test conditions	Limits			Unit
			Min	Typ*	Max	
V _{(BR)CEO}	Output sustaining voltage	I _{CEO} = 100μA	30			V
V _{CE(sat)}	Output saturation voltage	V _I = 2mA, I _C = 400mA		1.0	2.4	V
		V _I = 1mA, I _C = 200mA		0.8	1.6	
V _I	Input voltage	i _i = 1mA	0.6	1.35	1.7	V

* : A typical value is at T_a = 25°C.

TYPICAL CHARACTERISTICS

ALLOWABLE AVERAGE POWER DISSIPATION

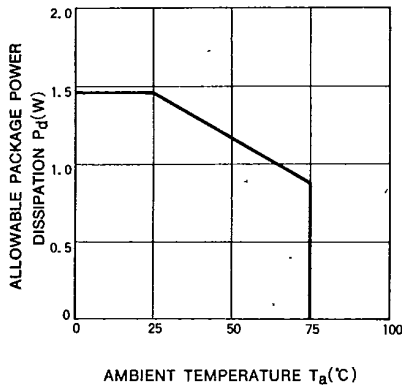

OUTPUT CURRENT CHARACTERISTICS

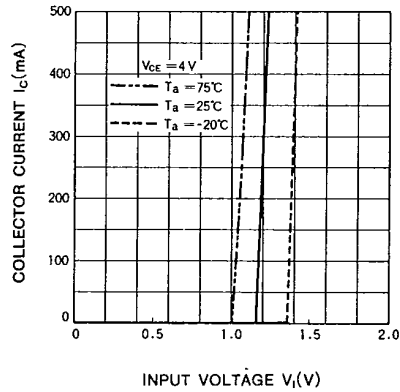

MITSUBISHI ELEK (LINEAR) 80 DE 6249826 0009210 6 M54521P

6249826 MITSUBISHI ELEK (LINEAR) 80C 09210 D 7-43-25

5-UNIT 500mA DARLINGTON TRANSISTOR ARRAY

ALLOWABLE COLLECTOR CURRENT AS A FUNCTION OF DUTY CYCLE

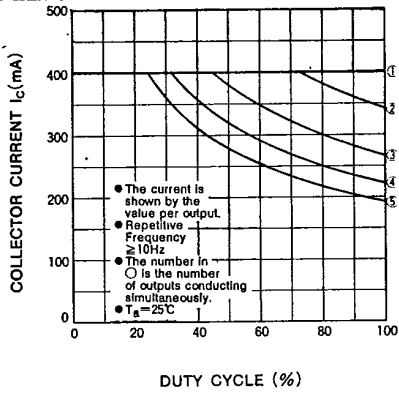

ALLOWABLE COLLECTOR CURRENT AS A FUNCTION OF DUTY CYCLE

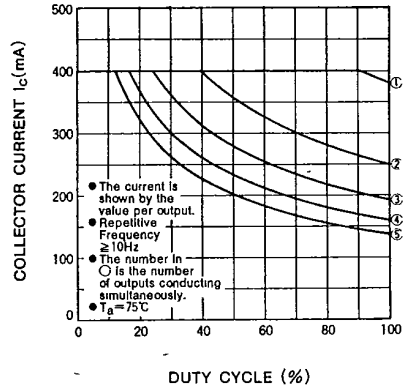

DC CURRENT GAIN CHARACTERISTICS

