

DESCRIPTION

The M66222 is a mail box that incorporates two complete CMOS shared memory cells of 128 × 8-bit configuration using high-performance silicon gate CMOS process technology, and are equipped with two access ports of A and B.

Access ports A and B are equipped with independent addresses \overline{CS} , \overline{WE} and \overline{OE} control pins and I/O pins to allow independent and asynchronous read/write operations individually. This product exclusively performs a write operation from A port and a read operation from B port for one memory, and a read operation from A port and a write operation from B port for the other memory.

FEATURES

- Memory configuration of 128 × 8 bits × 2 memory areas
- High-speed access, address access time 40ns (typ.)
- Complete asynchronous accessibility from ports A and B
- Fixed read/write access ports for memory
- Completely static operation
- Low power dissipation CMOS design
- 5V single power supply
- TTL direct-coupled I/O
- 3-state output for I/O pins

APPLICATION

Inter-MCU data transfer memory, communication buffer memory

PIN CONFIGURATION (Top view)

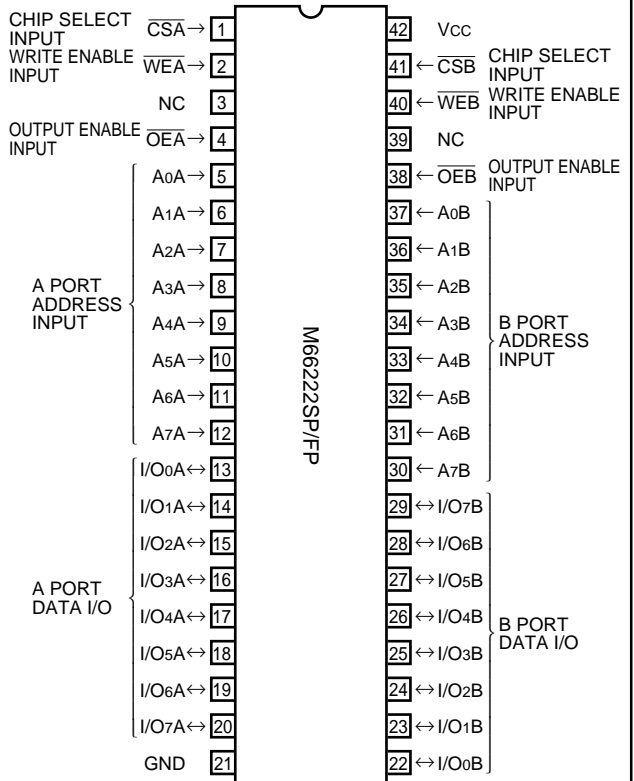

Outline 42P4B
 42P2R-A

NC: No Connection

BLOCK DIAGRAM

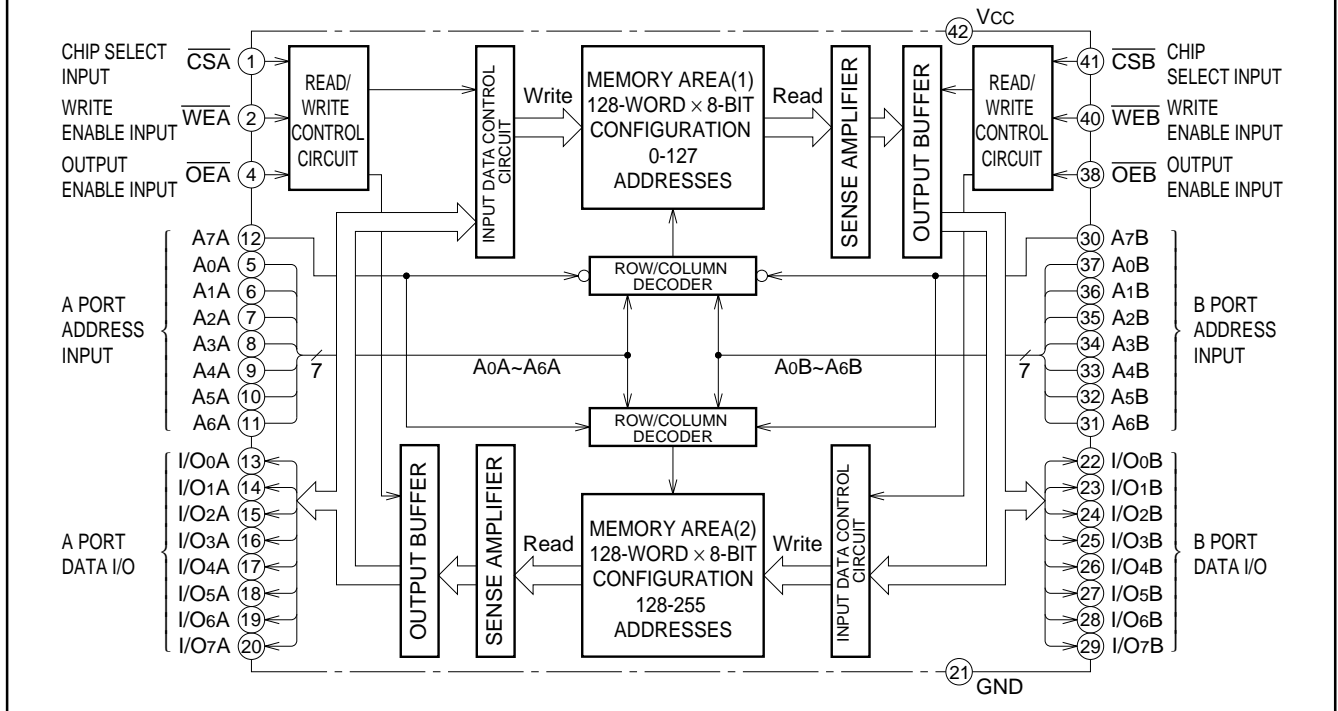

FUNCTION

The M66222 is a mail box most suitable for inter-MCU data communication interface. Provision of two pairs of addresses and data buses in its shared memory cell of 128 × 8-bit configuration allows independent and asynchronous read/write operations from/to two access ports of A and B individually.

Two memory areas of 128 × 8-bit configuration are incorporated in the chip. Memory area (1) is used only to perform a write operation from A port and a read operation from B port, and memory area (2) only to perform a read operation from A port and a write operation from B port.

In this case, address A7A should be set to "L" when writing data from A port in memory area (1), and address A7B should be set to "L" when reading data from B port in memory area (1). Also, address A7B should be set to "H" when writing data from B port in memory area (2), and address A7A should be set to "H" when reading data from A port in memory area (2).

Therefore, an attempt to set addresses A7A and A7B from each port in a mode other than the above setting invalidates any read/write operation from the corresponding port (See Table 1 and Fig 1).

As a basic write operation to memory, one of addresses A0 to A7 is specified. The CS signal is set to "L" to place one of I/O pins in the input mode. Also, the WE signal is set to "L". Data at the I/O pin is written into memory.

As a read operation, the WE signal is set to "H". Both CS signal and OE signal are set to "L" to place one of I/O pins in the output mode. One of addresses A0 to A7 is specified. Data at the specified address is thus output to the I/O pin.

When the CS signal is set to "H", the chip enters a non-select state which inhibits a read and write operation. At this time, the output is placed in the floating state (high impedance state), thus allowing OR tie with another chip. When the OE signal is set to "H", the output enters the floating state. In the I/O bus mode, setting the OE signal to "H" at a write time avoids contention of I/O bus data. When the CS signal is set to Vcc, the output enters the full stand-by state to minimize supply current (See Tables 2 and 3).

Table 1 Port Operations and Address A7 Setting Conditions

Access port	A port	B port
Write	A7A = "L"	A7B = "H"
Read	A7A = "H"	A7B = "L"

Note 1: No input data is written into any port having address A7 set under any condition other than Table 1. Undefined data is read to an output pin during a read operation.

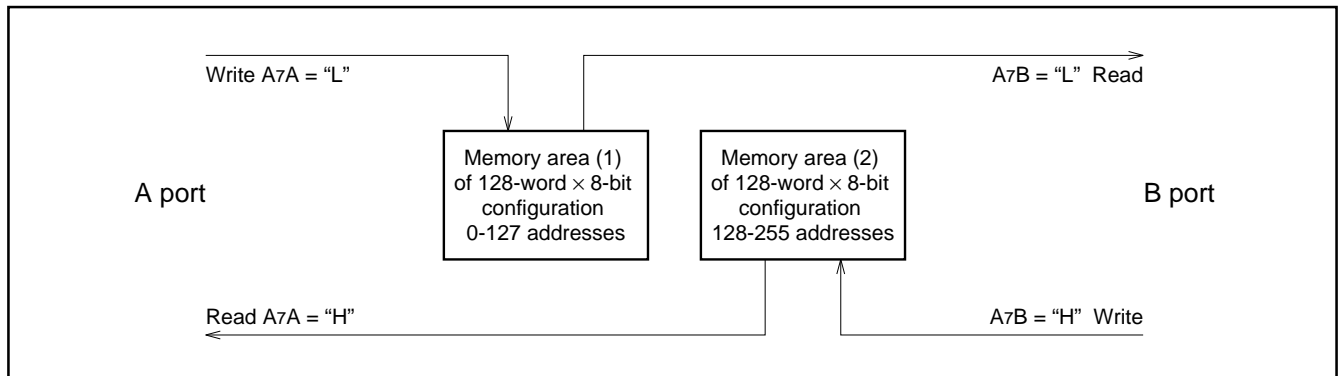

Fig 1 Access from Ports

Table 2 A Port Function Table

CSA	WEA	OEA	A7A	Mode	I/O pin	Icc
L	L	x	L	Write	DIN	Operation
			H	Invalid	DIN	Operation
L	H	L	L	Invalid	DOUT	Operation
			H	Read	DOUT	Operation
L	H	H	x	—	High impedance	Operation
H	x	x	x	Non-select	High impedance	Stand-by

Note 2: x indicates "L" or "H". (Irrelevant)
 "H" = High level, "L" = Low level

Table 3 B Port Function Table

CSB	WEB	OEB	A7B	Mode	I/O pin	Icc
L	L	x	L	Invalid	DIN	Operation
			H	Write	DIN	Operation
L	H	L	L	Read	DOUT	Operation
			H	Invalid	DOUT	Operation
L	H	H	x	—	High impedance	Operation
H	x	x	x	Non-select	High impedance	Stand-by

FUNCTIONAL DESCRIPTION

The M66222 with independent and asynchronous accessibility from two ports has the following four basic operations depending on an address and mode set from both ports:

- (1) A port Write B port Write
- (2) A port Write B port Read
- (3) A port Read B port Write
- (4) A port Read B port Read

In this case, the same address is not selected when the same read/write instruction is being executed at both ports as given in (1) and

(4). There is no concern about uncertainty of read/write data at an active address. If one port operates in the write mode and the other does in the read mode as given in (2) and (3), however, the same address may be selected. In this case, data of the port operating in the write mode is written. If the port in the read mode comes first, read data of the first-in port becomes uncertain until write data of the last-in port is determined (If the same address is selected, data of the port operating in the write mode is written into memory. Therefore, data of the port in the read mode may change from previously written data to newly written ones during the same cycle) (See Fig 2).

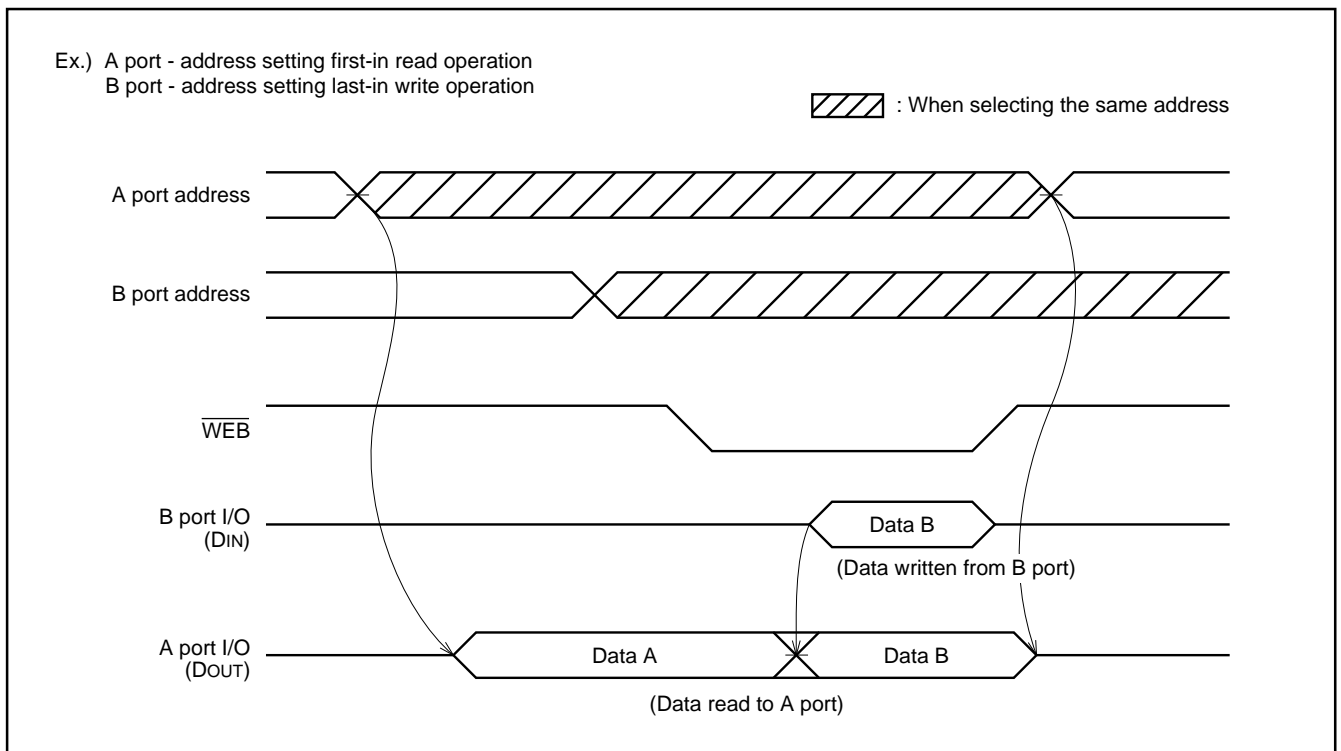

Fig 2 Example of Read Data Transition at Selection of Same Address

ABSOLUTE MAXIMUM RATINGS (Ta = 0 ~ 70°C, unless otherwise noted)

Symbol	Parameter	Conditions	Ratings	Unit
Vcc	Supply voltage	When defining GND pin as a reference.	-0.3 ~ +7.0	V
Vi	Input voltage		-0.3 ~ Vcc + 0.3	V
Vo	Output voltage		0 ~ Vcc	V
Pd	Maximum power dissipation	Ta = 25°C	700	mW
Tstg	Storage temperature range		-65 ~ 150	°C

RECOMMENDED OPERATING CONDITIONS

Symbol	Parameter	Limits			Unit
		Min.	Typ.	Max.	
Vcc	Supply voltage	4.5	5.0	5.5	V
GND	Ground		0		V
Vi	Input voltage	0		Vcc	V
Topr	Operating temperature range	0		70	°C

ELECTRICAL CHARACTERISTICS (Ta = 0 ~ 70°C, Vcc=5V±10%, unless otherwise noted)

Symbol	Parameter	Test conditions	Limits			Unit	
			Min.	Typ.	Max.		
VIH	"H" input voltage		2.2		Vcc+0.3	V	
VIL	"L" input voltage		-0.3		0.8	V	
VOH	"H" output voltage	IOH = -2mA	2.4			V	
VOL	"L" output voltage	IOl = 4mA			0.5	V	
IiH	"H" input current	Vi = Vcc			10.0	µA	
IiL	"L" input current	Vi = GND			-10.0	µA	
IOZH	Off state "H" output current	CS = VIH or OE = VIH Vo = Vcc			10.0	µA	
IOZL	Off state "L" output current	CS = VIH or OE = VIH Vo = GND			-10.0	µA	
Icc	Static current dissipation (active)	CS < 0.2V, Another input VIN > Vcc - 0.2V or VIN < 0.2V, Output pin open			60	mA	
ISB1	Stand-by current	Two-port stand-by			5	mA	
ISB2		One-port stand-by	CSA or CSB = VIH IOU = 0mA (Active port output pin open)			60	mA
ISB3		Two-port full stand-by	CSA, CSB > Vcc - 0.2V Another input VIN > Vcc - 0.2V or VIN < 0.2V			0.1	mA
ISB4		One-port full stand-by	CSA or CSB > Vcc - 0.2V Another input VIN > Vcc - 0.2V or VIN < 0.2V, IOU = 0mA (Active port output pin open)			30	mA
CI	Input capacitance				10	pF	
CO	Output capacitance in off state				15	pF	

Notes 3: The direction in which current flows into the IC is defined as positive (no sign).

4: The above typical values are standard values for Vcc=5V and Ta=25°C.

SWITCHING CHARACTERISTICS (Ta = 0 ~ 70°C, Vcc = 5V±10%, unless otherwise noted)

Read cycle

Symbol	Parameter	Limits			Unit
		Min.	Typ.	Max.	
tCR	Read cycle time	70			ns
ta(A)	Address access time			70	ns
ta(CS)	Chip select access time			70	ns
ta(OE)	Output enable access time			35	ns
t _{dis} (CS)	Output disable time after \overline{CS} (Note 5)			35	ns
t _{dis} (OE)	Output disable time after \overline{OE} (Note 5)			35	ns
t _{en} (CS)	Output enable time after \overline{CS} (Note 5)	5			ns
t _{en} (OE)	Output enable time after \overline{OE} (Note 5)	5			ns
t _v (A)	Data effective time after Address	10			ns

TIMING REQUIREMENTS (Ta = 0 ~ 70°C, Vcc = 5V±10%, unless otherwise noted)

Write cycle

Symbol	Parameter	Limits			Unit
		Min.	Typ.	Max.	
tCW	Write cycle time	70			ns
t _w (WE)	Write pulse width	45			ns
t _{su} (A)1	Address setup time (for \overline{WE})	0			ns
t _{su} (A)2	Address setup time (for \overline{CS})	0			ns
t _{su} (A-WEH)	Address setup time for rise of \overline{WE}	65			ns
t _{su} (CS)	Chip select setup time	65			ns
t _{su} (D)	Data setup time	40			ns
t _h (D)	Data hold time	0			ns
t _{rec} (WE)	Write recovery time	0			ns
t _{dis} (WE)	Output disable time after \overline{WE} (Note 5)			35	ns
t _{dis} (OE)	Output disable time after \overline{OE} (Note 5)			35	ns
t _{en} (WE)	Output enable time after \overline{WE} (Note 5)	0			ns
t _{en} (OE)	Output enable time after \overline{OE} (Note 5)	5			ns

Note 5: The time required for the output to change from a steady state to ±500mV under the load conditions shown in Figure 4.
This parameter is guaranteed but is not tested at shipment.

TIMING DIAGRAM

Read Cycle ($\overline{WE} = V_{IH}$)

Read cycle No. 1 (Address control) ($\overline{CS} = \overline{OE} = V_{IL}$)

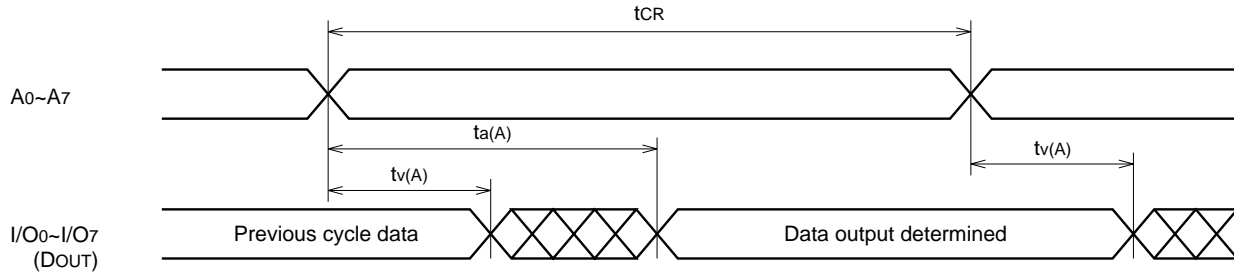

Read cycle No. 2 (\overline{CS} control)

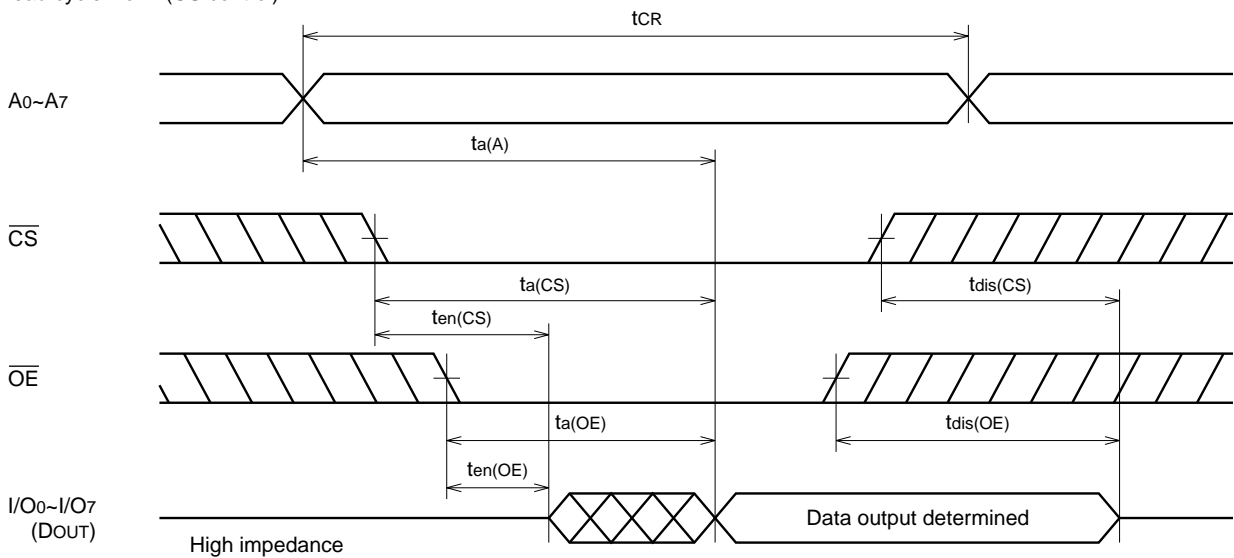

Write Cycle

Write cycle No.1 (\overline{WE} control) See Notes 6, 7 and 8.

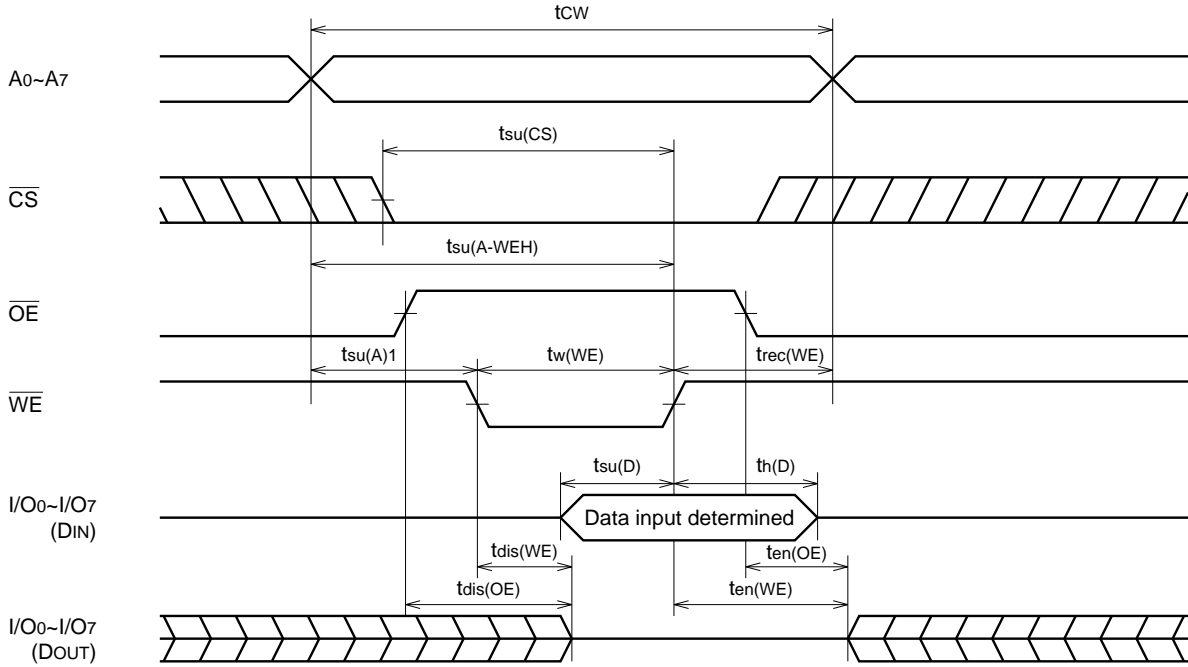

Write cycle No.2 (\overline{CS} control) See Notes 7 and 8.

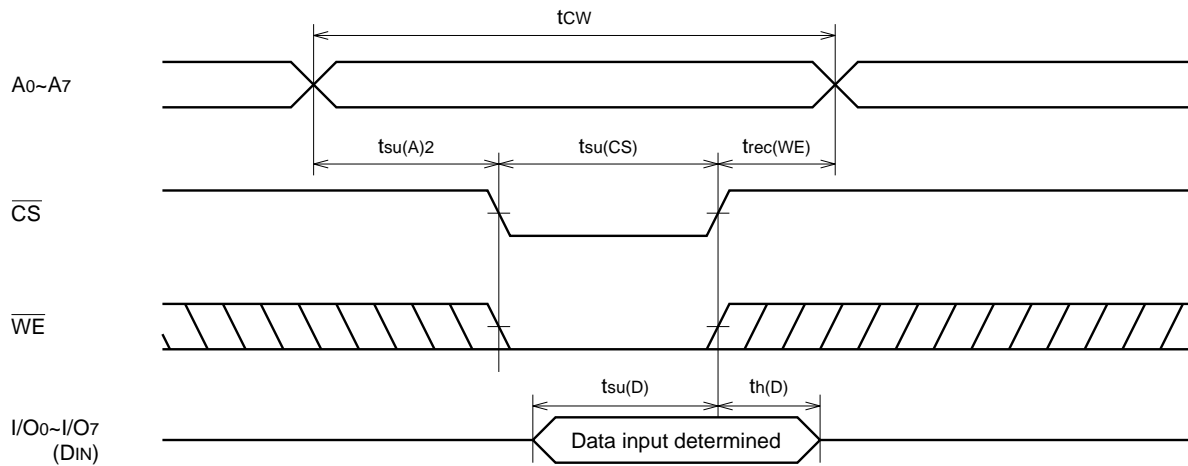

- Notes 6: The \overline{WE} of the port must be set to "H" when an address input changes.
- 7: A write operation is performed during the overlap period when both \overline{CS} and \overline{WE} are "L".
- 8: Do not apply any negative-phase signal from outside when an I/O pin is in output state.
- 9: The shaded part means a state in which a signal can be "H" or "L".

SWITCHING CHARACTERISTICS MEASUREMENT CIRCUIT

Input pulse level : $V_{IH} = 3.0V, V_{IL} = 0V$

Input pulse rise/fall time : $t_r/t_f = 5ns$

Input timing reference voltage : 1.5V

Output timing decision voltage : 1.5V

Output load : Figure 3 ~ 4 (The capacitance includes stray wiring capacitance and the probe input capacitance.)

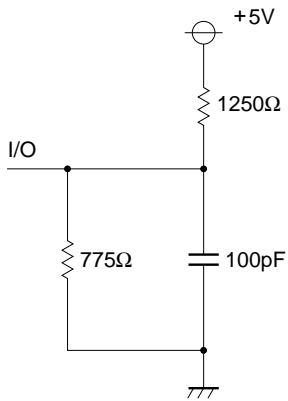

Fig 3. Output Load

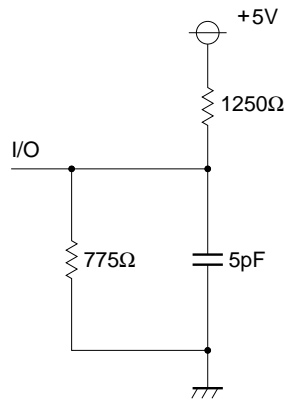

Fig 4. Output Load (to ten, tdis)