



Dual, Current-Limited, High-Side P-Channel Switches with Thermal Shutdown

MAX894L/MAX895L

General Description

The MAX894L/MAX895L smart, dual, low-voltage, P-channel, MOSFET power switches are intended for high-side load-switching applications. These switches operate with inputs from +2.7V to +5.5V, making them ideal for both 3V and 5V systems. Internal current-limiting circuitry protects the input supply against overload. Thermal-overload protection limits power dissipation and junction temperature.

The MAX894L/MAX895L's maximum current limits are 500mA and 250mA, respectively. The current limit through the switches is programmed with resistors from SET A/SET B to ground. When the switches are on, the quiescent supply current is a low 16 μ A. When the switches are off, the supply current decreases to 0.1 μ A.

The MAX894L/MAX895L are available in an 8-pin SO package.

Features

- ◆ **+2.7V to +5.5V Input Range**
- ◆ **Programmable Current Limits**
- ◆ **Low Supply Current:**
 16 μ A I_Q at V_{IN} = 3.3V
 0.1 μ A with Switch Off
- ◆ **Thermal Shutdown**

Ordering Information

PART*	TEMP. RANGE	PIN-PACKAGE	CURRENT LIMIT
MAX894LC/D	0°C to +70°C	Dice**	500mA
MAX894LESA	-40°C to +85°C	8 SO	500mA
MAX895LC/D	0°C to +70°C	Dice**	250mA
MAX895LESA	-40°C to +85°C	8 SO	250mA

*To order these units in tape and reel, add (-T) to the end of the part number.

**Dice are tested at T_A = +25°C.

Applications

- PCMCIA Slots
- Access Bus Slots
- Portable Equipment

Typical Operating Circuit

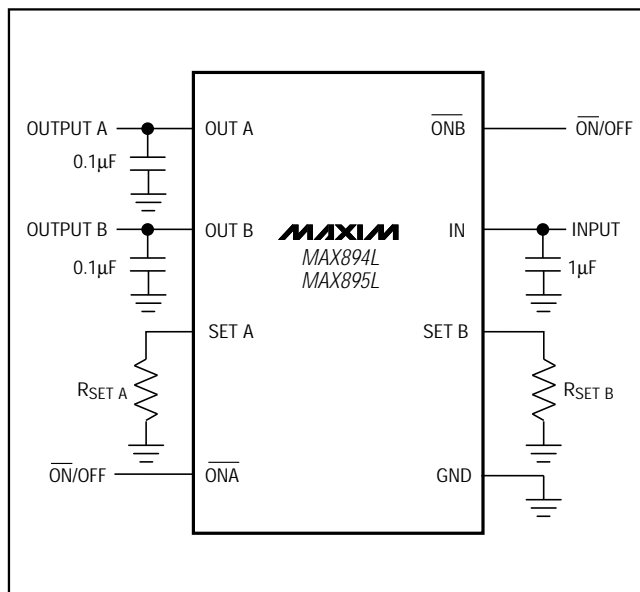

Pin Configuration

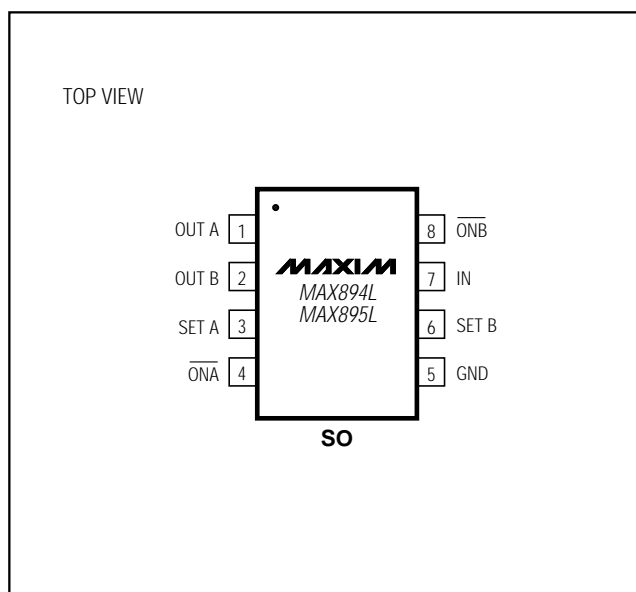

Dual, Current-Limited, High-Side P-Channel Switches with Thermal Shutdown

ABSOLUTE MAXIMUM RATINGS

IN to GND	-0.3V to 6V	Continuous Power Dissipation (T _A = +70°C)	
ON _A , ON _B to GND	-0.3V to 6V	SO (derate 5.88mW/°C above +70°C)	471mW
SET A, SET B, OUT A, OUT B to GND	-0.3V to (V _{IN} + 0.3V)	Operating Temperature Range	
Maximum Continuous Switch Current		MAX89_LESA	-40°C to +85°C
MAX894L	0.75A	Storage Temperature Range	-65°C to +150°C
MAX895L	0.375A	Lead Temperature (soldering, 10sec)	+300°C

Stresses beyond those listed under "Absolute Maximum Ratings" may cause permanent damage to the device. These are stress ratings only, and functional operation of the device at these or any other conditions beyond those indicated in the operational sections of the specifications is not implied. Exposure to absolute maximum rating conditions for extended periods may affect device reliability.

ELECTRICAL CHARACTERISTICS

(V_{IN} = 3V, T_A = 0°C to +85°C, unless otherwise noted. Typical values are at T_A = +25°C.)

PARAMETER	CONDITION	MIN	TYP	MAX	UNITS	
Operating Voltage		2.7		5.5	V	
Quiescent Current	V _{IN} = 5V, ON _A = ON _B = GND, I _{OUT A} = I _{OUT B} = 0		18	30	μA	
Off-Supply Current	ON _A = ON _B = IN, V _{IN} = V _{OUT A} = V _{OUT B} = 5.5V		0.03	1	μA	
Off-Switch Current	ON _A = ON _B = IN, V _{IN} = 5.5V, V _{OUT A} = V _{OUT B} = 0		0.04	3	μA	
Undervoltage Lockout	Rising edge, 1% hysteresis	2.0	2.4	2.6	V	
On-Resistance	V _{IN} = 4.5V	MAX894L	120	225	mΩ	
		MAX895L	250	420		
	V _{IN} = 3.0V	MAX894L	150	300		
		MAX895L	300	500		
Current-Limit-Amplifier Threshold	V _{SET} required to turn the switch off (Note 1)	1.178	1.240	1.302	V	
Maximum Output Current	MAX894L		500		mA	
	MAX895L		250			
I _{OUT} to I _{SET} Current Ratio	V _{OUT} = 1.6V to 2.8V	MAX894L, I _{OUT} = 250mA	945	1085	1270	A/A
		MAX895L, I _{OUT} = 125mA	910	1050	1235	
ON _A , ON _B Input Low Voltage	V _{IN} = 2.7V to 5.5V			0.8	V	
ON _A , ON _B Input High Voltage	V _{IN} = 2.7V to 3.6V	2.0			V	
	V _{IN} = 4.5V to 5.5V	2.4				
ON _A , ON _B Input Leakage	V _{ON_A} = V _{ON_B} = 5.5V		0.01	1	μA	
I _{SETA} , I _{SETB} Bias Current	V _{SET A} = 1.24V, ON _A = 0, ON _B = V _{IN} , I _{OUT A} = 0		0.5	3	μA	
	V _{SET B} = 1.24V, ON _B = 0, ON _A = V _{IN} , I _{OUT B} = 0		0.5	3		
Slow-Current-Loop Response Time	20% current overdrive, V _{CC} = 5V		5		μs	
Fast-Current-Loop Response Time			2		μs	
Turn-On Time	V _{IN} = 5V, I _{OUT} = 250mA (MAX894L), 125mA (MAX895L)		100	200	μs	
	V _{IN} = 3V, I _{OUT} = 250mA (MAX894L), 125mA (MAX895L)		150			
Turn-Off Time		0.8	1.2	20	μs	

Note 1: Tested with I_{OUT} = 50mA for the MAX894L and 25mA for the MAX895L, and V_{SET} raised until V_{IN} - V_{OUT} ≥ 0.8V.

Dual, Current-Limited, High-Side P-Channel Switches with Thermal Shutdown

MAX894L/MAX895L

ELECTRICAL CHARACTERISTICS (Note 2)

($V_{IN} = 3V$, $T_A = -40^{\circ}C$ to $+85^{\circ}C$, unless otherwise noted. Typical values are at $T_A = +25^{\circ}C$.)

PARAMETER	CONDITION		MIN	TYP	MAX	UNITS
Operating Voltage			3.0		5.5	V
Quiescent Current	$V_{IN} = 5V, \overline{ON}A = \overline{ON}B = GND, I_{OUT A} = I_{OUT B} = 0$				50	μA
Off-Supply Current	$\overline{ON}A = \overline{ON}B = IN, V_{IN} = V_{OUT A} = V_{OUT B} = 5.5V$				2.2	μA
Off-Switch Current	$\overline{ON}A = \overline{ON}B = IN, V_{IN} = 5.5V, V_{OUT A} = V_{OUT B} = 0$				8	μA
Undervoltage Lockout	Rising edge, 1% hysteresis		2.0		2.9	V
On-Resistance	$V_{IN} = 4.5V$	MAX894L			250	m Ω
		MAX895L			420	
	$V_{IN} = 3.0V$	MAX894L			300	
		MAX895L			500	
Current-Limit-Amplifier Threshold	$V_{SET_}$ required to turn the switch off (Note 1)		1.14		1.34	V
I_{OUT} to I_{SET} Current Ratio	$V_{SET} = 1.24V,$ $V_{OUT} = 1.6V$ to $2.8V$	MAX894L, $I_{OUT} = 250mA$	910		1360	A/A
		MAX895L, $I_{OUT} = 125mA$	880		1315	
Turn-On Time	$V_{IN} = 5V$				200	μs
Turn-Off Time			0.25		20	μs

Note 2: Specifications to $-40^{\circ}C$ are guaranteed by design, not production tested.

Dual, Current-Limited, High-Side P-Channel Switches with Thermal Shutdown

Typical Operating Characteristics

(Typical Operating Circuit, $T_A = +25^\circ\text{C}$, unless otherwise noted.)

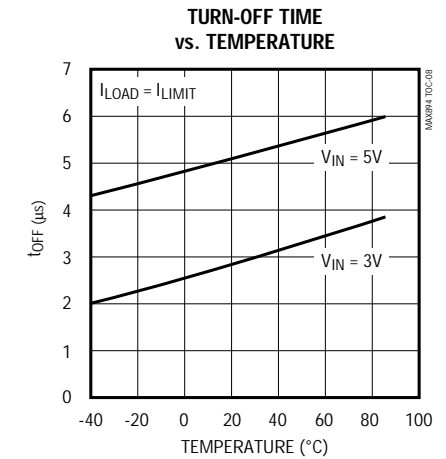
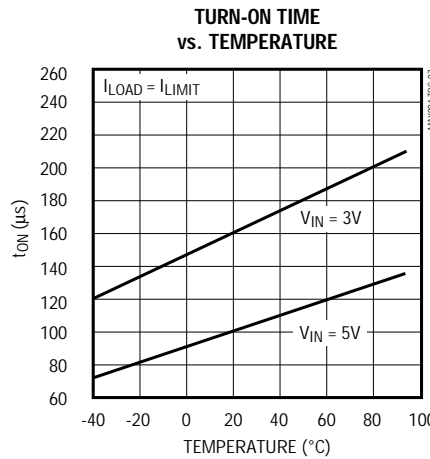
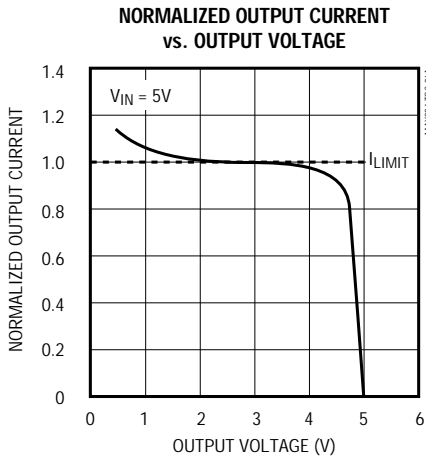
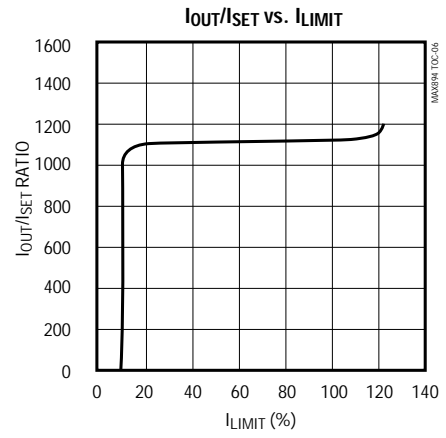
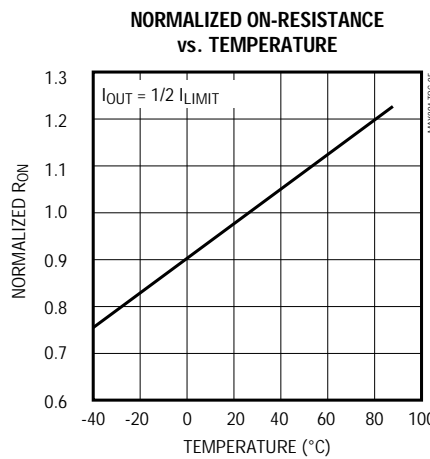
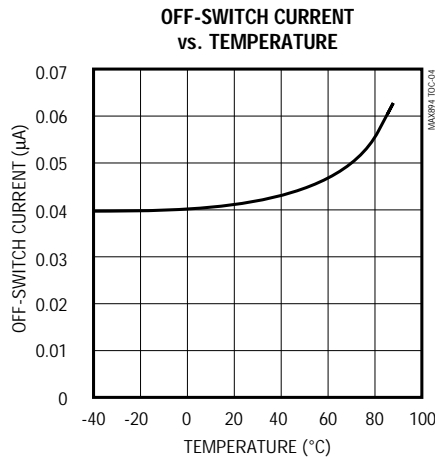
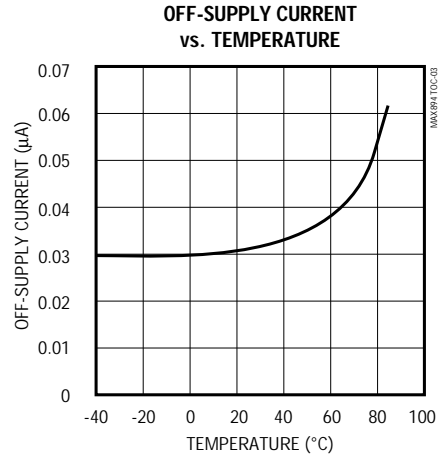
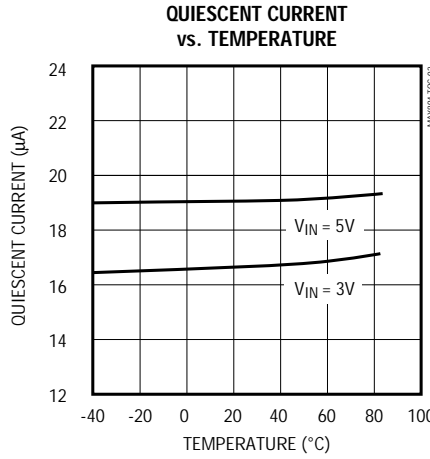
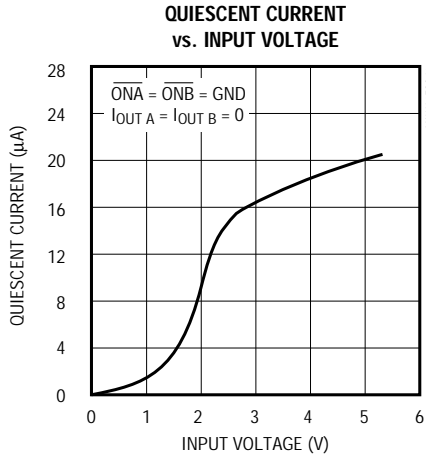

Dual, Current-Limited, High-Side P-Channel Switches with Thermal Shutdown

Typical Operating Characteristics (continued)

(Typical Operating Circuit, $T_A = +25^\circ\text{C}$, unless otherwise noted.)

CURRENT-LIMIT RESPONSE
(MAX894L, $R_L = 1\Omega$)

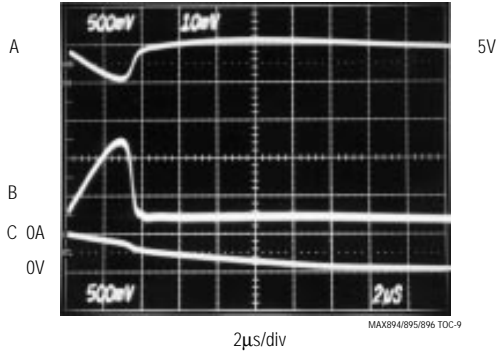

$C_{IN} = 47\mu\text{F}$, $C_{OUT} = 0.1\mu\text{F}$
A: V_{IN} , 500mV/div, AC coupled
B: I_{OUT} , 2A/div
C: V_{OUT} , 5V/div

CURRENT-LIMIT RESPONSE
(MAX894L, $R_L = 0.7\Omega$)

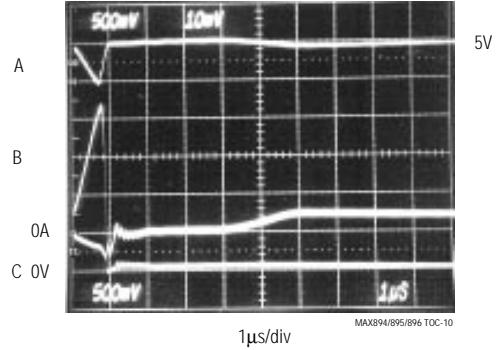

$C_{IN} = 47\mu\text{F}$, $C_{OUT} = 0.1\mu\text{F}$
A: V_{IN} , 500mV/div, AC coupled
B: I_{OUT} , 2A/div
C: V_{OUT} , 5V/div

LOAD-TRANSIENT RESPONSE
(MAX894L)

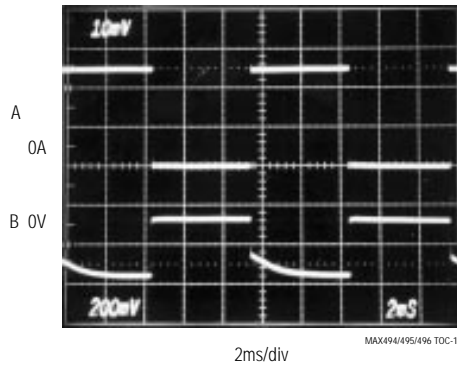

$V_{IN} = 5\text{V}$
A: $I_{OUT} = 0$ to 500mA, 0.2A/div
B: V_{OUT} RIPPLE, 200mV/div, AC COUPLED

SWITCH TURN-ON TIME

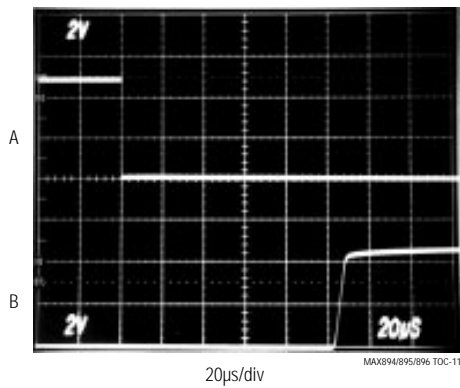

$V_{IN} = 5\text{V}$, $I_{OUT} = I_{LIMIT}$
A: V_{ON} , 2V/div
B: V_{OUT} , 2V/div

SWITCH TURN-OFF TIME

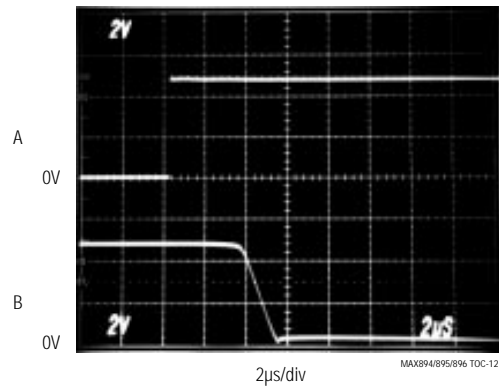

$V_{IN} = 5\text{V}$, $I_{OUT} = I_{LIMIT}$
A: V_{ON} , 2V/div
B: V_{OUT} , 2V/div

MAX894L/MAX895L

Dual, Current-Limited, High-Side P-Channel Switches with Thermal Shutdown

Pin Description

PIN	NAME	FUNCTION
1	OUT A	Switch A Output. P-channel MOSFET drain. Bypass OUT A with a 0.1 μ F capacitor to ground.
2	OUT B	Switch B Output. P-channel MOSFET drain. Bypass OUT B with a 0.1 μ F capacitor to ground.
3	SET A	Set Current-Limit Input. A resistor from SET A to ground sets the current limit for switch A. See <i>Setting the Current Limit</i> section.
4	$\overline{\text{ONA}}$	Active-Low Switch A On Input. A logic low turns switch A on.
5	GND	Ground
6	SET B	Set Current-Limit Input. A resistor from SET B to ground sets the current limit for switch B. See <i>Setting the Current Limit</i> section.
7	IN	Input, Switches A and B. P-channel MOSFET source. Bypass IN with a 1 μ F capacitor to ground.
8	$\overline{\text{ONB}}$	Active-Low Switch B On Input. A logic low turns switch B on.

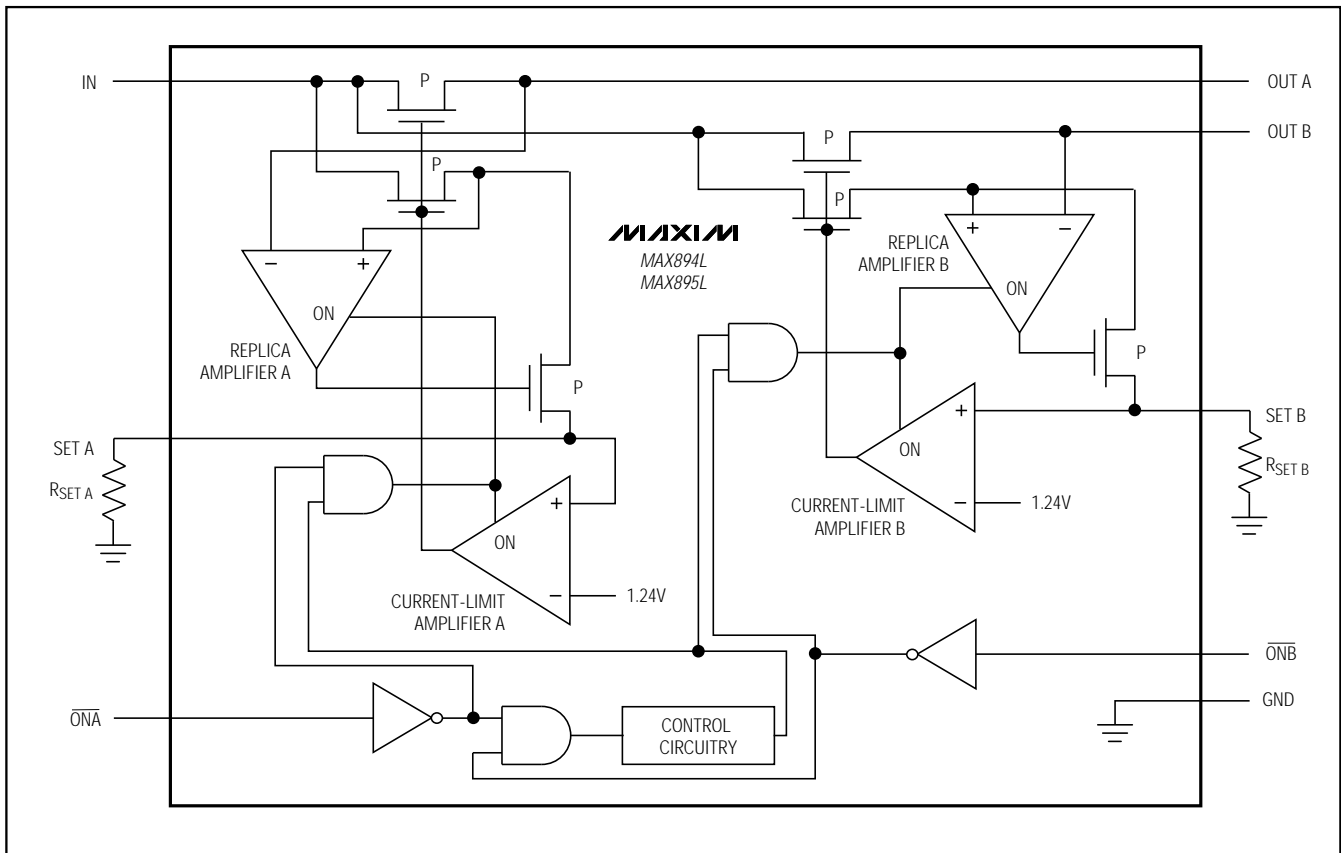

Figure 1. Functional Diagram

Dual, Current-Limited, High-Side P-Channel Switches with Thermal Shutdown

Detailed Description

The MAX894L/MAX895L P-channel MOSFET power switches limit output current to a user-programmed level. When the output current is increased beyond the set current level, the current also increases through the replica switch ($I_{OUT}/1050$) (MAX895) and through R_{SET} (Figure 1). The current-limit error amplifier compares the voltage across R_{SET} to the internal 1.24V reference, and regulates the current back to the lesser of the programmed current limit (I_{LIMIT}) or the maximum current limit (I_{MAX}).

These switches are not bidirectional; therefore, the input voltage must be higher than the output voltage.

Setting the Current Limit

The MAX894L/MAX895L feature internal current-limiting circuitry with maximum programmable values (I_{MAX}) of 500mA, and 250mA, respectively. For best performance, set the current limit (I_{LIMIT}) between $0.2I_{MAX} \leq I_{LIMIT} \leq I_{MAX}$. This current limit remains in effect throughout the input supply-voltage range.

Program the current limit with a resistor (R_{SET}) connected from SET_{-} to ground (Figure 2) as follows:

$$I_{SET} = I_{LIMIT} / I_{RATIO}$$

$$R_{SET} = 1.24V / I_{SET} = (1.24V \times I_{RATIO}) / I_{LIMIT}$$

where I_{LIMIT} is the desired current limit for either switch and I_{RATIO} is the I_{OUT} to I_{SET} current ratio (1085mA for the MAX894L and 1050mA for the MAX895L).

Short-Circuit Protection

The MAX894L/MAX895L are short-circuit-protected switches. In the event of an output short circuit or current-overload condition, the current through either switch is limited by the internal current-limiting error amplifier to $1.5 \times I_{LIMIT}$. When the fault condition is removed, the replica error amplifier sets the current limit back to I_{LIMIT} .

For a high $\Delta V_{DS}/\Delta t$ during an output short-circuit condition, the switch turns off and disconnects the input supply from the output. The current-limiting amplifier then slowly turns the switch on with the output current limited to $1.5 \times I_{SET}$. When the fault condition is removed, the current limit is set back to I_{LIMIT} . Refer to Output Short-Circuit Fast-Loop Response and Output Short-Circuit Slow-Loop Response in the *Typical Operating Characteristics*.

Thermal Shutdown

The MAX894L/MAX895L feature thermal shutdown. The switch turns off when the junction temperature exceeds $+135^{\circ}\text{C}$. Once the device cools by 10°C , the switch turns back on. If the fault short-circuit condition is not removed, the switch cycles on and off, resulting in a pulsed output.

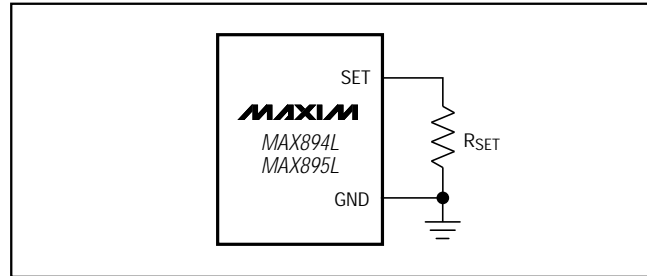

Figure 2. Setting the Current Limit

Applications Information

Input Capacitor

To limit input voltage drop during momentary output short-circuit conditions, place a capacitor from IN to GND. A $1\mu\text{F}$ ceramic capacitor is adequate for most applications; however, higher capacitor values further reduce voltage drop at the input.

Output Capacitor

Connect a $0.1\mu\text{F}$ capacitor from OUT to GND. This capacitor prevents inductive parasitics from pulling OUT negative during turn-off.

Layout and Thermal-Dissipation Consideration

To take full advantage of the switch-response time to output short-circuit conditions, it is very important to keep all traces as short as possible, reducing the effect of undesirable parasitic inductance. Place input and output capacitors as close as possible to the device (no more than 5mm).

Under normal operating conditions, the package can dissipate and channel heat away. Calculate the maximum power as follows:

$$P = I_{LIMITA}^2 \times \overline{R_{ONA}} + I_{LIMITB}^2 \times \overline{R_{ONB}}$$

where $\overline{R_{ONA}}$ and $\overline{R_{ONB}}$ are the on-resistances of switches A and B, respectively.

When one or both outputs are short circuited, the voltage drop across the switch equals the input supply. Hence, the power dissipated across the switch increases, as does the die temperature. If the fault condition is not removed, the thermal-overload-protection circuitry turns the switch off until the die temperature falls by 10°C . A ground plane in contact with the device helps to further dissipate heat.

Dual, Current-Limited, High-Side P-Channel Switches with Thermal Shutdown

Chip Information

TRANSISTOR COUNT: 453

SUBSTRATE CONNECTED TO GND.

Tape-and-Reel Information

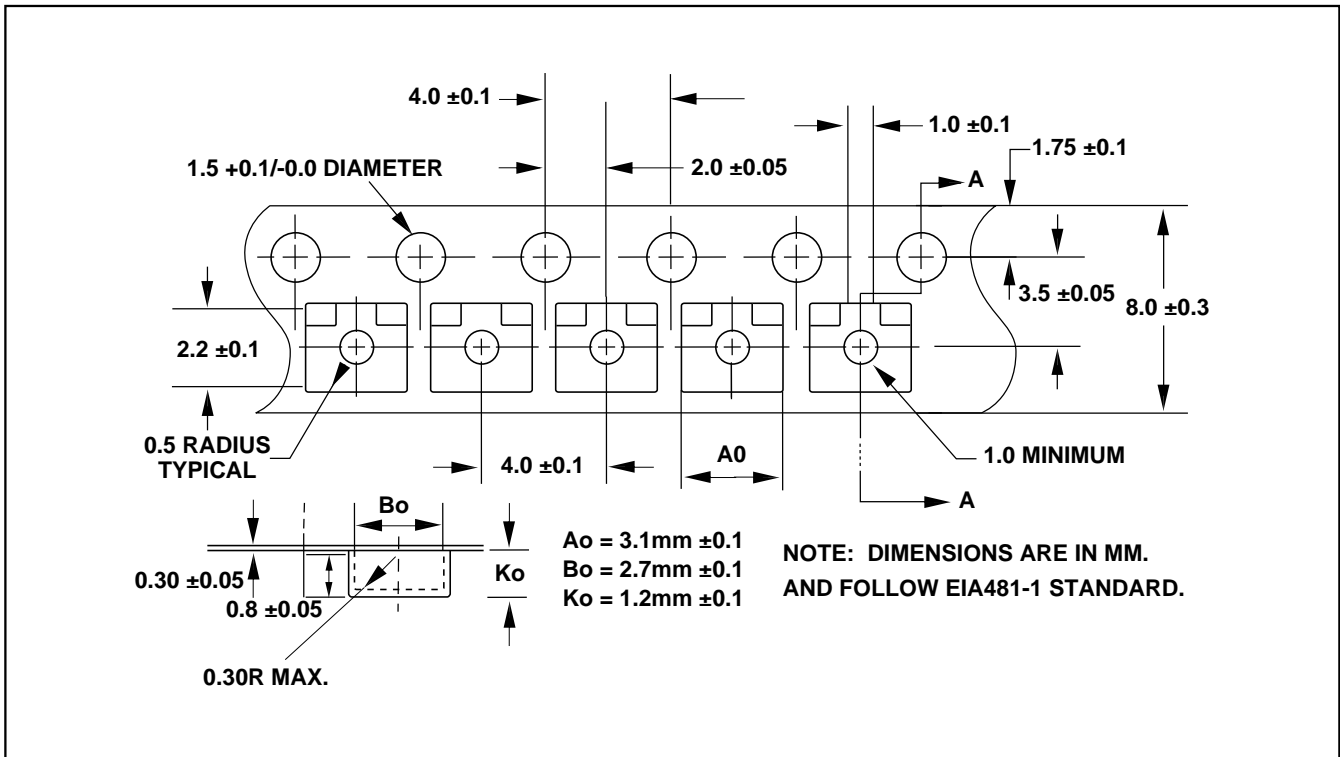

Maxim cannot assume responsibility for use of any circuitry other than circuitry entirely embodied in a Maxim product. No circuit patent licenses are implied. Maxim reserves the right to change the circuitry and specifications without notice at any time.

8 Maxim Integrated Products, 120 San Gabriel Drive, Sunnyvale, CA 94086 (408) 737-7600