

MC14557B

1-to-64 Bit Variable Length Shift Register

The MC14557B is a static clocked serial shift register whose length may be programmed to be any number of bits between 1 and 64. The number of bits selected is equal to the sum of the subscripts of the enabled Length Control inputs (L1, L2, L4, L8, L16, and L32) plus one. Serial data may be selected from the A or B data inputs with the A/B select input. This feature is useful for recirculation purposes. A Clock Enable (CE) input is provided to allow gating of the clock or negative edge clocking capability.

The device can be effectively used for variable digital delay lines or simply to implement odd length shift registers.

- 1–64 Bit Programmable Length
- Q and \bar{Q} Serial Buffered Outputs
- Asynchronous Master Reset
- All Inputs Buffered
- No Limit On Clock Rise and Fall Times
- Supply Voltage Range = 3.0 Vdc to 18 Vdc
- Capable of Driving Two Low–power TTL Loads or one Low–power Schottky TTL Load Over the Rated Temperature Range

MAXIMUM RATINGS (Voltages Referenced to V_{SS}) (Note 2.)

Symbol	Parameter	Value	Unit
V_{DD}	DC Supply Voltage Range	–0.5 to +18.0	V
V_{in}, V_{out}	Input or Output Voltage Range (DC or Transient)	–0.5 to $V_{DD} + 0.5$	V
I_{in}, I_{out}	Input or Output Current (DC or Transient) per Pin	± 10	mA
P_D	Power Dissipation, per Package (Note 3.)	500	mW
T_A	Ambient Temperature Range	–55 to +125	°C
T_{stg}	Storage Temperature Range	–65 to +150	°C
T_L	Lead Temperature (8–Second Soldering)	260	°C

2. Maximum Ratings are those values beyond which damage to the device may occur.

3. Temperature Derating:
Plastic "P and D/DW" Packages: – 7.0 mW/°C From 65°C To 125°C

This device contains protection circuitry to guard against damage due to high static voltages or electric fields. However, precautions must be taken to avoid applications of any voltage higher than maximum rated voltages to this high–impedance circuit. For proper operation, V_{in} and V_{out} should be constrained to the range $V_{SS} \leq (V_{in} \text{ or } V_{out}) \leq V_{DD}$.

Unused inputs must always be tied to an appropriate logic voltage level (e.g., either V_{SS} or V_{DD}). Unused outputs must be left open.



ON Semiconductor

<http://onsemi.com>

MARKING DIAGRAMS

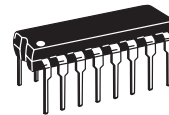

PDIP–16
P SUFFIX
CASE 648

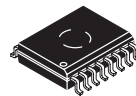
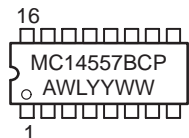

SOIC–16
DW SUFFIX
CASE 751G

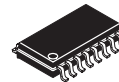
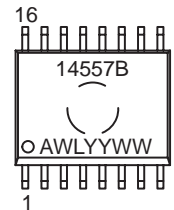

SOEIAJ–16
F SUFFIX
CASE 966

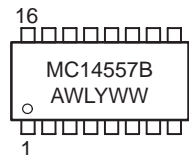

A = Assembly Location
WL or L = Wafer Lot
YY or Y = Year
WW or W = Work Week

ORDERING INFORMATION

Device	Package	Shipping
MC14557BCP	PDIP–16	2000/Box
MC14557BDW	SOIC–16	47/Rail
MC14557BDWR2	SOIC–16	1000/Tape & Reel
MC14557BF	SOEIAJ–16	See Note 1.
MC14557BFEL	SOEIAJ–16	See Note 1.

1. For ordering information on the EIAJ version of the SOIC packages, please contact your local ON Semiconductor representative.

MC14557B

PIN ASSIGNMENT

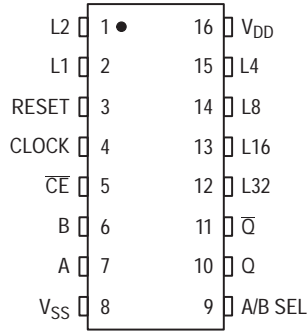

BLOCK DIAGRAM

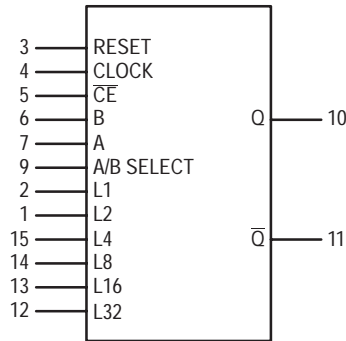

V_{DD} = PIN 16
V_{SS} = PIN 8

TRUTH TABLE

Inputs				Output
Rst	A/B	Clock	CE	Q
0	0		0	B
0	1		0	A
0	0	1		B
0	1	1		A
1	X	X	X	0

Q is the output of the first selected shift register stage.

X = Don't Care

LENGTH SELECT TRUTH TABLE

L32	L16	L8	L4	L2	L1	Register Length
0	0	0	0	0	0	1 Bit
0	0	0	0	0	1	2 Bits
0	0	0	0	1	0	3 Bits
0	0	0	0	1	1	4 Bits
0	0	0	1	0	0	5 Bits
0	0	0	1	0	1	6 Bits
⋮	⋮	⋮	⋮	⋮	⋮	⋮
⋮	⋮	⋮	⋮	⋮	⋮	⋮
1	0	0	0	0	0	33 Bits
1	0	0	0	0	1	34 Bits
⋮	⋮	⋮	⋮	⋮	⋮	⋮
⋮	⋮	⋮	⋮	⋮	⋮	⋮
1	1	1	1	0	0	61 Bits
1	1	1	1	1	1	62 Bits
1	1	1	1	1	0	63 Bits
1	1	1	1	0	1	64 Bits

NOTE: Length equals the sum of the binary length control subscripts plus one.

MC14557B

ELECTRICAL CHARACTERISTICS (Voltages Referenced to V_{SS})

Characteristic	Symbol	V _{DD} Vdc	- 55°C		25°C			125°C		Unit
			Min	Max	Min	Typ (4.)	Max	Min	Max	
Output Voltage V _{in} = V _{DD} or 0 V _{in} = 0 or V _{DD}	"0" Level V _{OL}	5.0	—	0.05	—	0	0.05	—	0.05	Vdc
		10	—	0.05	—	0	0.05	—	0.05	
		15	—	0.05	—	0	0.05	—	0.05	
	"1" Level V _{OH}	5.0	4.95	—	4.95	5.0	—	4.95	—	Vdc
		10	9.95	—	9.95	10	—	9.95	—	
		15	14.95	—	14.95	15	—	14.95	—	
Input Voltage "0" Level (V _O = 4.5 or 0.5 Vdc) (V _O = 9.0 or 1.0 Vdc) (V _O = 13.5 or 1.5 Vdc) "1" Level (V _O = 0.5 or 4.5 Vdc) (V _O = 1.0 or 9.0 Vdc) (V _O = 1.5 or 13.5 Vdc)	V _{IL}	5.0	—	1.5	—	2.25	1.5	—	1.5	Vdc
		10	—	3.0	—	4.50	3.0	—	3.0	
		15	—	4.0	—	6.75	4.0	—	4.0	
	V _{IH}	5.0	3.5	—	3.5	2.75	—	3.5	—	Vdc
		10	7.0	—	7.0	5.50	—	7.0	—	
		15	11	—	11	8.25	—	11	—	
Output Drive Current (V _{OH} = 2.5 Vdc) (V _{OH} = 4.6 Vdc) (V _{OH} = 9.5 Vdc) (V _{OH} = 13.5 Vdc) (V _{OL} = 0.4 Vdc) (V _{OL} = 0.5 Vdc) (V _{OL} = 1.5 Vdc)	Source I _{OH}	5.0	-3.0	—	-2.4	-4.2	—	-1.7	—	mAdc
		5.0	-0.64	—	-0.51	-0.88	—	-0.36	—	
		10	-1.6	—	-1.3	-2.25	—	-0.9	—	
		15	-4.2	—	-3.4	-8.8	—	-2.4	—	
	Sink I _{OL}	5.0	0.64	—	0.51	0.88	—	0.36	—	
		10	1.6	—	1.3	2.25	—	0.9	—	
15	4.2	—	3.4	8.8	—	2.4	—	—		
Input Current	I _{in}	15	—	±0.1	—	±0.00001	±0.1	—	±1.0	μAdc
Input Capacitance (V _{in} = 0)	C _{in}	—	—	—	—	5.0	7.5	—	—	pF
Quiescent Current (Per Package)	I _{DD}	5.0	—	5.0	—	0.010	5.0	—	150	μAdc
		10	—	10	—	0.020	10	—	300	
		15	—	20	—	0.030	20	—	600	
Total Supply Current (5.) (6.) (Dynamic plus Quiescent, Per Package) (C _L = 50 pF on all outputs, all buffers switching)	I _T	5.0 10 15	I _T = (1.75 μA/kHz) f + I _{DD} I _T = (3.50 μA/kHz) f + I _{DD} I _T = (5.25 μA/kHz) f + I _{DD}							μAdc

4. Data labelled "Typ" is not to be used for design purposes but is intended as an indication of the IC's potential performance.

5. The formulas given are for the typical characteristics only at 25°C.

6. To calculate total supply current at loads other than 50 pF:

$$I_T(C_L) = I_T(50 \text{ pF}) + (C_L - 50) \text{ Vfk}$$

where: I_T is in μA (per package), C_L in pF, V = (V_{DD} - V_{SS}) in volts, f in kHz is input frequency, and k = 0.001.

MC14557B

SWITCHING CHARACTERISTICS (7.) ($C_L = 50 \text{ pF}$, $T_A = 25^\circ\text{C}$)

Characteristic	Symbol	V_{DD}	Min	Typ (8.)	Max	Unit
Rise and Fall Time, Q or \bar{Q} Output t_{TLH} , $t_{THL} = (1.5 \text{ ns/pF}) C_L + 25 \text{ ns}$ t_{TLH} , $t_{THL} = (0.75 \text{ ns/pF}) C_L + 12.5 \text{ ns}$ t_{TLH} , $t_{THL} = (0.55 \text{ ns/pF}) C_L + 9.5 \text{ ns}$	t_{TLH} , t_{THL}	5 10 15	— — —	100 50 40	200 100 80	ns
Propagation Delay, Clock or \bar{CE} to Q or \bar{Q} t_{PLH} , $t_{PHL} = (1.7 \text{ ns/pF}) C_L + 215 \text{ ns}$ t_{PLH} , $t_{PHL} = (0.66 \text{ ns/pF}) C_L + 97 \text{ ns}$ t_{PLH} , $t_{PHL} = (0.5 \text{ ns/pF}) C_L + 65 \text{ ns}$	t_{PLH} , t_{PHL}	5 10 15	— — —	300 130 90	600 260 180	ns
Propagation Delay, Reset to Q or \bar{Q} t_{PLH} , $t_{PHL} = (1.7 \text{ ns/pF}) C_L + 215 \text{ ns}$ t_{PLH} , $t_{PHL} = (0.66 \text{ ns/pF}) C_L + 97 \text{ ns}$ t_{PLH} , $t_{PHL} = (0.5 \text{ ns/pF}) C_L + 70 \text{ ns}$	t_{PLH} , t_{PHL}	5 10 15	— — —	300 130 95	600 260 190	ns
Pulse Width, Clock	$t_{WH(cl)}$	5 10 15	200 100 75	95 45 35	— — —	ns
Pulse Width, Reset	$t_{WH(rst)}$	5 10 15	300 140 100	150 70 50	— — —	ns
Clock Frequency (50% Duty Cycle)	f_{cl}	5 10 15	— — —	3.0 7.5 13.0	1.7 5.0 6.7	MHz
Setup Time, A or B to Clock or \bar{CE} Worst case condition: $L1 = L2 = L4 = L8 = L16 = L32 = V_{SS}$ (Register Length = 1) Best case condition: $L32 = V_{DD}$, L1 through L16 = Don't Care (Any register length from 33 to 64)	t_{su}	5 10 15 5 10 15	700 290 145 400 165 60	350 130 85 45 5 0	— — — — — —	ns
Hold Time, Clock or \bar{CE} to A or B Best case condition: $L1 = L2 = L4 = L8 = L16 = L32 = V_{SS}$ (Register Length = 1) Worst case condition: $L32 = V_{DD}$, L1 through L16 = Don't Care (Any register length from 33 to 64)	t_h	5 10 15 5 10 15	200 100 10 400 185 85	- 150 - 60 - 50 50 25 22	— — — — — —	ns
Rise and Fall Time, Clock	t_r , t_f	5 10 15	No Limit			—
Rise and Fall Time, Reset or \bar{CE}	t_r , t_f	5 10 15	— — —	— — —	15 5 4	μs
Removal Time, Reset to Clock or \bar{CE}	t_{rem}	5 10 15	160 80 70	80 40 35	— — —	ns

7. The formulas given are for the typical characteristics only at 25°C .

8. Data labelled "Typ" is not to be used for design purposes but is intended as an indication of the IC's potential performance.

MC14557B

TIMING DIAGRAM

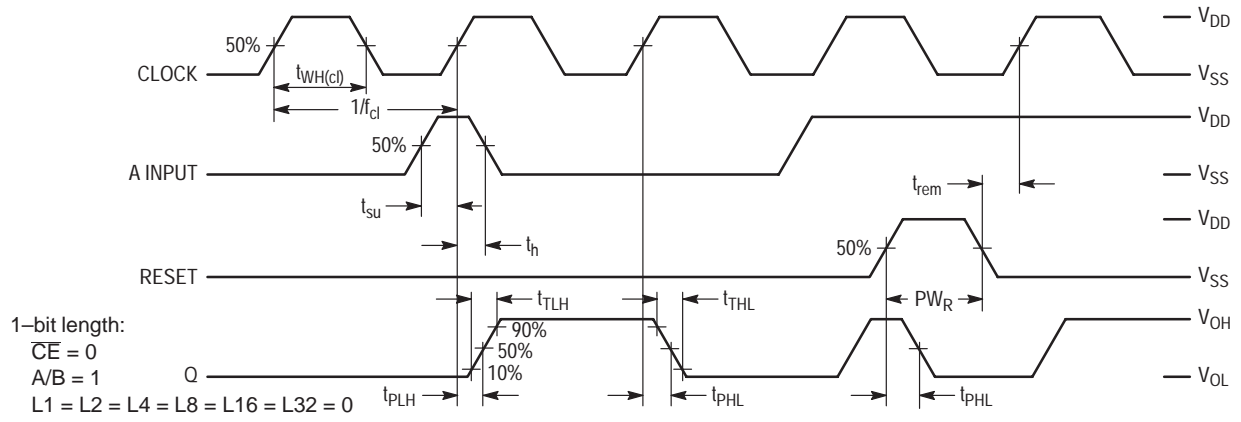

MC14557B

PACKAGE DIMENSIONS

PDIP-16 P SUFFIX PLASTIC DIP PACKAGE CASE 648-08 ISSUE R



- NOTES:
1. DIMENSIONING AND TOLERANCING PER ANSI Y14.5M, 1982.
 2. CONTROLLING DIMENSION: INCH.
 3. DIMENSION L TO CENTER OF LEADS WHEN FORMED PARALLEL.
 4. DIMENSION B DOES NOT INCLUDE MOLD FLASH.
 5. ROUNDED CORNERS OPTIONAL.

DIM	INCHES		MILLIMETERS	
	MIN	MAX	MIN	MAX
A	0.740	0.770	18.80	19.55
B	0.250	0.270	6.35	6.85
C	0.145	0.175	3.69	4.44
D	0.015	0.021	0.39	0.53
F	0.040	0.70	1.02	1.77
G	0.100 BSC		2.54 BSC	
H	0.050 BSC		1.27 BSC	
J	0.008	0.015	0.21	0.38
K	0.110	0.130	2.80	3.30
L	0.295	0.305	7.50	7.74
M	0°	10°	0°	10°
S	0.020	0.040	0.51	1.01

SOIC-16 DW SUFFIX PLASTIC SOIC PACKAGE CASE 751G-03 ISSUE B

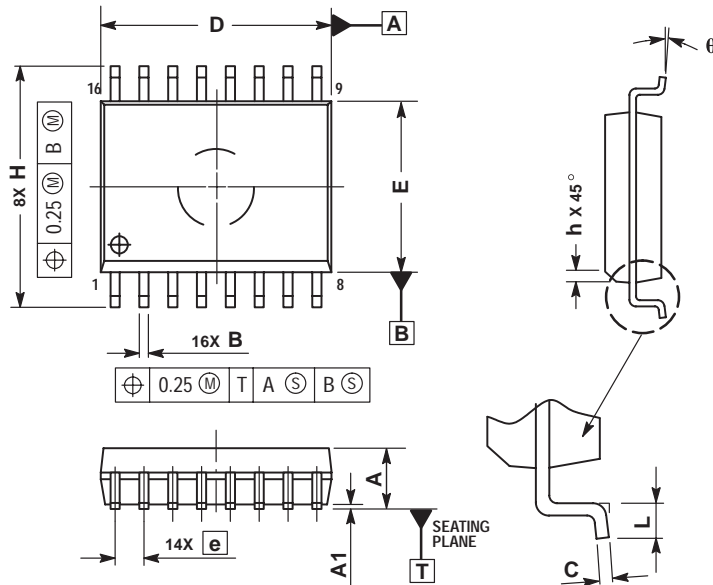

- NOTES:
1. DIMENSIONS ARE IN MILLIMETERS.
 2. INTERPRET DIMENSIONS AND TOLERANCES PER ASME Y14.5M, 1994.
 3. DIMENSIONS D AND E DO NOT INCLUDE MOLD PROTRUSION.
 4. MAXIMUM MOLD PROTRUSION 0.15 PER SIDE.
 5. DIMENSION B DOES NOT INCLUDE DAMBAR PROTRUSION. ALLOWABLE DAMBAR PROTRUSION SHALL BE 0.13 TOTAL IN EXCESS OF THE B DIMENSION AT MAXIMUM MATERIAL CONDITION.

DIM	MILLIMETERS	
	MIN	MAX
A	2.35	2.65
A1	0.10	0.25
B	0.35	0.49
C	0.23	0.32
D	10.15	10.45
E	7.40	7.60
e	1.27 BSC	
H	10.05	10.55
h	0.25	0.75
L	0.50	0.90
θ	0°	7°

MC14557B

PACKAGE DIMENSIONS

SOEIAJ-16 F SUFFIX PLASTIC EIAJ SOIC PACKAGE CASE 966-01 ISSUE O

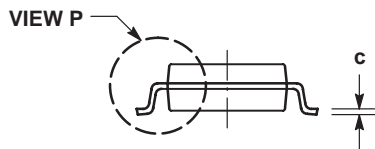
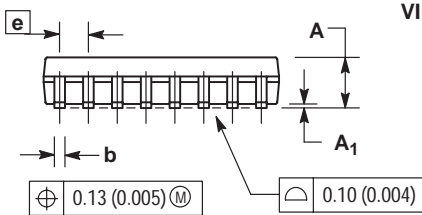
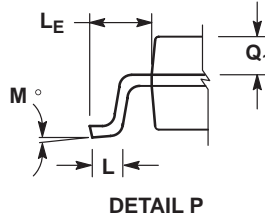
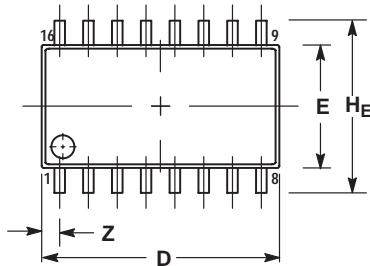

NOTES:

1. DIMENSIONING AND TOLERANCING PER ANSI Y14.5M, 1982.
2. CONTROLLING DIMENSION: MILLIMETER.
3. DIMENSIONS D AND E DO NOT INCLUDE MOLD FLASH OR PROTRUSIONS AND ARE MEASURED AT THE PARTING LINE. MOLD FLASH OR PROTRUSIONS SHALL NOT EXCEED 0.15 (0.006) PER SIDE.
4. TERMINAL NUMBERS ARE SHOWN FOR REFERENCE ONLY.
5. THE LEAD WIDTH DIMENSION (b) DOES NOT INCLUDE DAMBAR PROTRUSION. ALLOWABLE DAMBAR PROTRUSION SHALL BE 0.08 (0.003) TOTAL IN EXCESS OF THE LEAD WIDTH DIMENSION AT MAXIMUM MATERIAL CONDITION. DAMBAR CANNOT BE LOCATED ON THE LOWER RADIUS OR THE FOOT. MINIMUM SPACE BETWEEN PROTRUSIONS AND ADJACENT LEAD TO BE 0.46 (0.018).

DIM	MILLIMETERS		INCHES	
	MIN	MAX	MIN	MAX
A	---	2.05	---	0.081
A ₁	0.05	0.20	0.002	0.008
b	0.35	0.50	0.014	0.020
c	0.18	0.27	0.007	0.011
D	9.90	10.50	0.390	0.413
E	5.10	5.45	0.201	0.215
e	1.27 BSC		0.050 BSC	
H _E	7.40	8.20	0.291	0.323
L	0.50	0.85	0.020	0.033
L _E	1.10	1.50	0.043	0.059
M	0°	10°	0°	10°
Q ₁	0.70	0.90	0.028	0.035
Z	---	0.78	---	0.031

ON Semiconductor and  are trademarks of Semiconductor Components Industries, LLC (SCILLC). SCILLC reserves the right to make changes without further notice to any products herein. SCILLC makes no warranty, representation or guarantee regarding the suitability of its products for any particular purpose, nor does SCILLC assume any liability arising out of the application or use of any product or circuit, and specifically disclaims any and all liability, including without limitation special, consequential or incidental damages. "Typical" parameters which may be provided in SCILLC data sheets and/or specifications can and do vary in different applications and actual performance may vary over time. All operating parameters, including "Typicals" must be validated for each customer application by customer's technical experts. SCILLC does not convey any license under its patent rights nor the rights of others. SCILLC products are not designed, intended, or authorized for use as components in systems intended for surgical implant into the body, or other applications intended to support or sustain life, or for any other application in which the failure of the SCILLC product could create a situation where personal injury or death may occur. Should Buyer purchase or use SCILLC products for any such unintended or unauthorized application, Buyer shall indemnify and hold SCILLC and its officers, employees, subsidiaries, affiliates, and distributors harmless against all claims, costs, damages, and expenses, and reasonable attorney fees arising out of, directly or indirectly, any claim of personal injury or death associated with such unintended or unauthorized use, even if such claim alleges that SCILLC was negligent regarding the design or manufacture of the part. SCILLC is an Equal Opportunity/Affirmative Action Employer.

PUBLICATION ORDERING INFORMATION

NORTH AMERICA Literature Fulfillment:

Literature Distribution Center for ON Semiconductor
P.O. Box 5163, Denver, Colorado 80217 USA
Phone: 303-675-2175 or 800-344-3860 Toll Free USA/Canada
Fax: 303-675-2176 or 800-344-3867 Toll Free USA/Canada
Email: ONlit@hibbertco.com
Fax Response Line: 303-675-2167 or 800-344-3810 Toll Free USA/Canada

N. American Technical Support: 800-282-9855 Toll Free USA/Canada

EUROPE: LDC for ON Semiconductor – European Support

German Phone: (+1) 303-308-7140 (M-F 1:00pm to 5:00pm Munich Time)
Email: ONlit-german@hibbertco.com
French Phone: (+1) 303-308-7141 (M-F 1:00pm to 5:00pm Toulouse Time)
Email: ONlit-french@hibbertco.com
English Phone: (+1) 303-308-7142 (M-F 12:00pm to 5:00pm UK Time)
Email: ONlit@hibbertco.com

EUROPEAN TOLL-FREE ACCESS*: 00-800-4422-3781

*Available from Germany, France, Italy, England, Ireland

CENTRAL/SOUTH AMERICA:

Spanish Phone: 303-308-7143 (Mon-Fri 8:00am to 5:00pm MST)
Email: ONlit-spanish@hibbertco.com

ASIA/PACIFIC: LDC for ON Semiconductor – Asia Support

Phone: 303-675-2121 (Tue-Fri 9:00am to 1:00pm, Hong Kong Time)
Toll Free from Hong Kong & Singapore:
001-800-4422-3781
Email: ONlit-asia@hibbertco.com

JAPAN: ON Semiconductor, Japan Customer Focus Center
4-32-1 Nishi-Gotanda, Shinagawa-ku, Tokyo, Japan 141-8549

Phone: 81-3-5740-2745
Email: r14525@onsemi.com

ON Semiconductor Website: <http://onsemi.com>

For additional information, please contact your local Sales Representative.