

**1 Mbps, OPEN COLLECTOR OUTPUT, FOR GATE DRIVE INTERFACE
INTELLIGENT POWER MODULE
5-PIN SOP PHOTOCOUPLER**

–NEPOC™ Series–

DESCRIPTION

The PS9713 is an optically coupled isolator containing a GaAlAs LED on the input side and a photo diode and a signal processing circuit on the output side on one chip.

FEATURES

- High instantaneous common mode rejection voltage ($CM_H, CM_L = \pm 15 \text{ kV}/\mu\text{s MIN.}$)
- Small package (5-pin SOP)
- High-speed response ($t_{PHL} = 500 \text{ ns MAX.}, t_{PLH} = 750 \text{ ns MAX.}$)
- Maximum propagation delays ($t_{PLH} - t_{PHL} = 270 \text{ ns TYP.}$)
- Pulse width distortion ($|t_{PHL} - t_{PLH}| = 270 \text{ ns TYP.}$)
- Ordering number of taping product: PS9713-F3, F4: 3 500 pcs/reel
- UL approved: File No. E72422 (S)
- VDE0884 approved (Option)

APPLICATIONS

- IPM Driver
- General purpose inverter

The information in this document is subject to change without notice. Before using this document, please confirm that this is the latest version.
Not all devices/types available in every country. Please check with local NEC representative for availability and additional information.

PACKAGE DIMENSIONS (in millimeters)

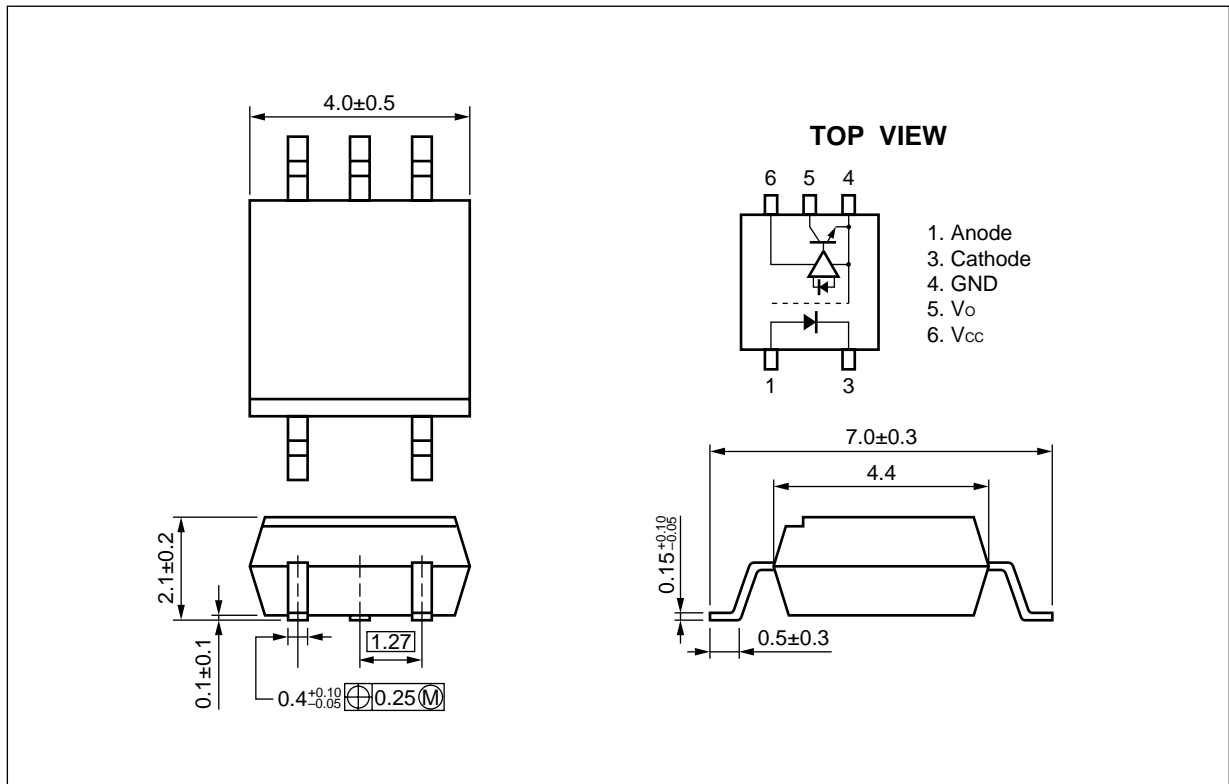

FUNCTIONAL DIAGRAM

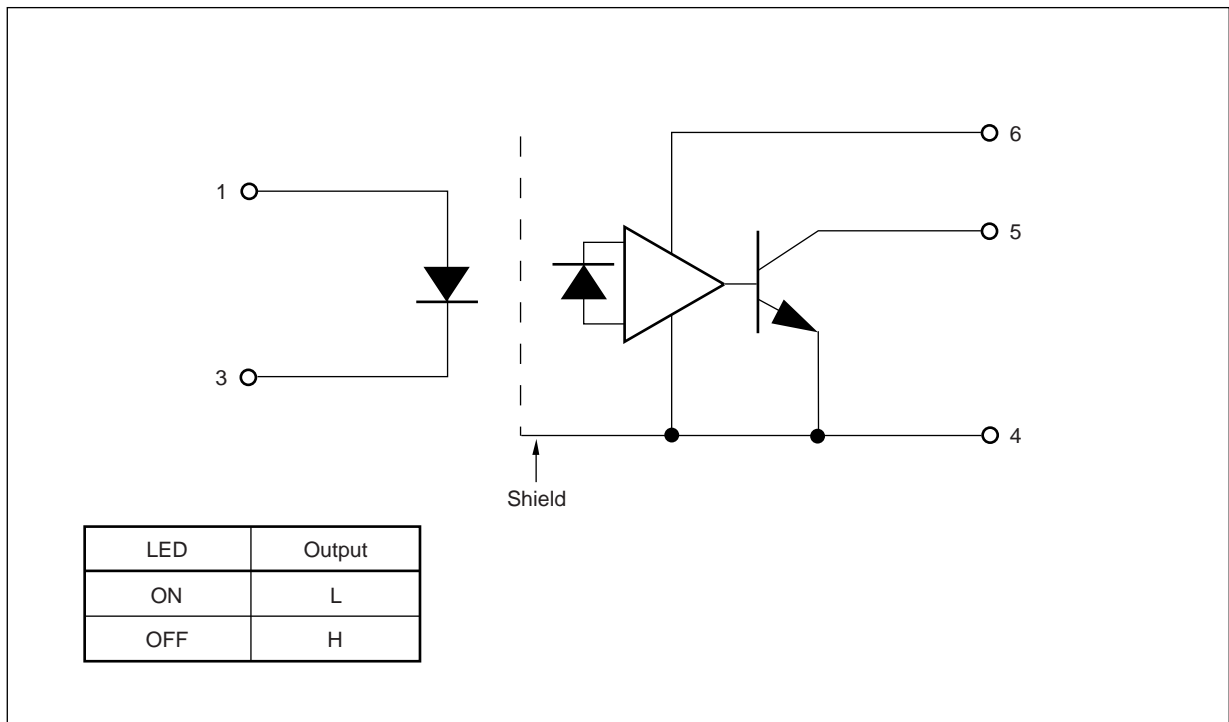

ORDERING INFORMATION

Part Number	Package	Packing Style	Safety Standards Approval	Application Part Number ^{*1}
PS9713	5-pin SOP	Magazine case 100 pcs	UL approved	PS9713
PS9713-F3		Embossed Tape 3 500 pcs/reel		
PS9713-F4			VDE0884 approved	
PS9713-V		Magazine case 100 pcs		
PS9713-V-F3		Embossed Tape 3 500 pcs/reel		
PS9713-V-F4				

*1 For the application of the Safety Standard, following part number should be used.

ABSOLUTE MAXIMUM RATINGS (T_A = 25 °C, unless otherwise specified)

Parameter		Symbol	Ratings	Unit
Diode	Forward Current	I _F	25	mA
	Reverse Voltage	V _R	3.0	V
Detector	Supply Voltage	V _{CC}	-0.5 to +35	V
	Output Voltage	V _O	-0.5 to +35	V
	Output Current	I _O	15	mA
	Power Dissipation	P _C	100	mW
Isolation Voltage ^{*1}		BV	2 500	Vr.m.s.
Operating Ambient Temperature		T _A	-40 to +100	°C
Storage Temperature		T _{stg}	-55 to +125	°C

*1 AC voltage for 1 minute at T_A = 25 °C, RH = 60 % between input and output.

RECOMMENDED OPERATING CONDITIONS

Parameter	Symbol	MIN.	TYP.	MAX.	Unit
High Level Input Current	I _{FH}	10		20	mA
Output Voltage	V _O	0		30	V
Supply Voltage	V _{CC}	4.5		30	V
LED Off Voltage	V _F	0		0.8	V

ELECTRICAL CHARACTERISTICS (T_A = -40 to +100 °C, V_{CC} = 15 V, unless otherwise specified)

Parameter		Symbol	Conditions	MIN.	TYP. ¹⁾	MAX.	Unit
Diode	Forward Voltage	V _F	I _F = 10 mA	1.3	1.65	2.1	V
	Reverse Current	I _R	V _R = 3 V			200	μA
	Terminal Capacitance	C _t	V = 0 V, f = 1 MHz, T _A = 25 °C		30		pF
Detector	Low Level Output Voltage	V _{OL}	I _F = 10 mA, V _{CC} = 5 V, I _O = 2.4 mA		0.13	0.6	V
	High Level Output Current	I _{OH}	V _{CC} = 30 V, V _F = 0.8 V		1.0	50	μA
	High Level Supply Current	I _{CCH}	V _{CC} = 30 V, V _F = 0.8 V, V _O = open		0.6	1.3	mA
	Low Level Supply Current	I _{CCL}	V _{CC} = 30 V, I _F = 10 mA, V _O = open		0.6	1.3	mA
Coupled	Threshold Input Current (H → L)	I _{FHL}	V _O = 0.8 V, I _O = 0.75 mA		1.5	5.0	mA
	Current Transfer Ratio (I _C /I _F)	CTR	I _F = 10 mA, V _O = 0.6 V	44	110		%
	Isolation Resistance	R _{I-O}	V _{I-O} = 1 kV _{DC} , RH = 40 to 60 %, T _A = 25 °C	10 ¹¹			Ω
	Isolation Capacitance	C _{I-O}	V = 0 V, f = 1 MHz, T _A = 25 °C		0.6		pF
	Propagation Delay Time (H → L) ²⁾	t _{PHL}	I _F = 10mA, R _L = 20 kΩ, C _L = 100 pF, V _{THHL} = 1.5 V, V _{THLH} = 2.0 V		250	500	ns
	Propagation Delay Time (L → H) ²⁾	t _{PLH}			520	750	
	Maximum Propagation Delays	t _{PLH} -t _{PHL}		-200	270	650	
	Pulse Width Distortion (PWD) ²⁾	t _{PHL} -t _{PLH}			270	650	
	Instantaneous Common Mode Rejection Voltage (Output: High) ³⁾	CM _H		T _A = 25 °C, I _F = 0 mA, V _O > 3.0 V, V _{CM} = 1.5 kV, R _L = 20 kΩ, C _L = 100 pF	15		
	Instantaneous Common Mode Rejection Voltage (Output: Low) ³⁾	CM _L	T _A = 25 °C, I _F = 10 mA, V _O < 1.0 V, V _{CM} = 1.5 kV, R _L = 20 kΩ, C _L = 100 pF	15			kV/μs

*1 Typical values at $T_A = 25\text{ }^\circ\text{C}$.

*2 Test circuit for propagation delay time

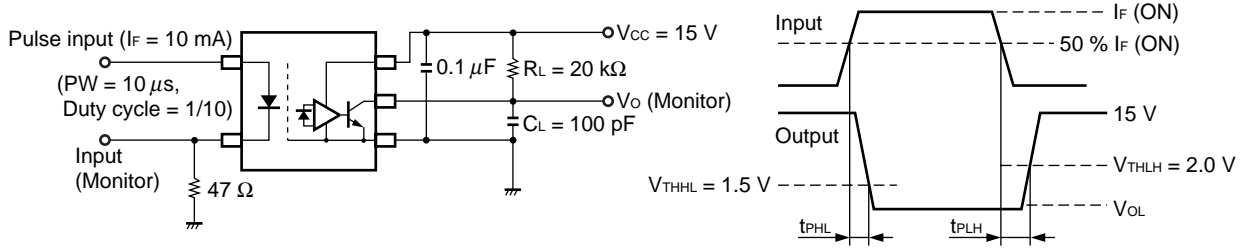

C_L is approximately which includes probe and stray wiring capacitance.

*3 Test circuit for common mode transient immunity

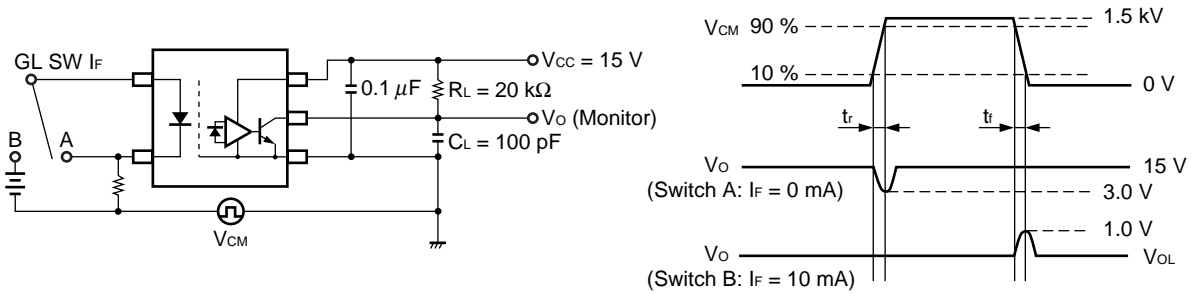

C_L is approximately which includes probe and stray wiring capacitance.

USAGE CAUTION

By-pass capacitor of more than $0.1\text{ }\mu\text{F}$ is used between V_{CC} and GND near device. Also, ensure that the distance between the leads of the photocoupler and capacitor is no more than 10 mm.

TYPICAL CHARACTERISTICS (T_A = 25 °C, unless otherwise specified)

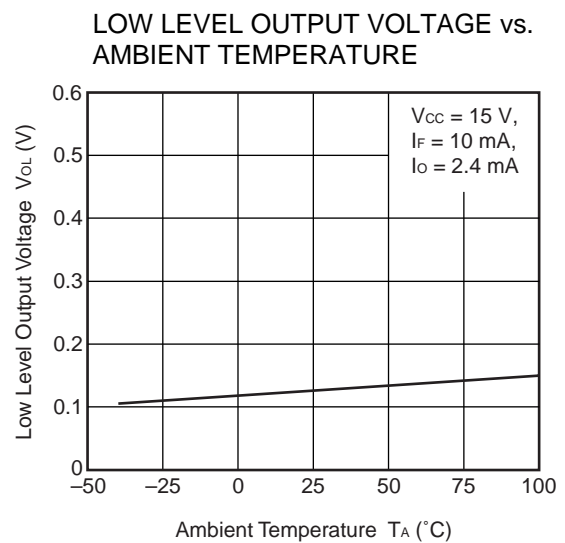
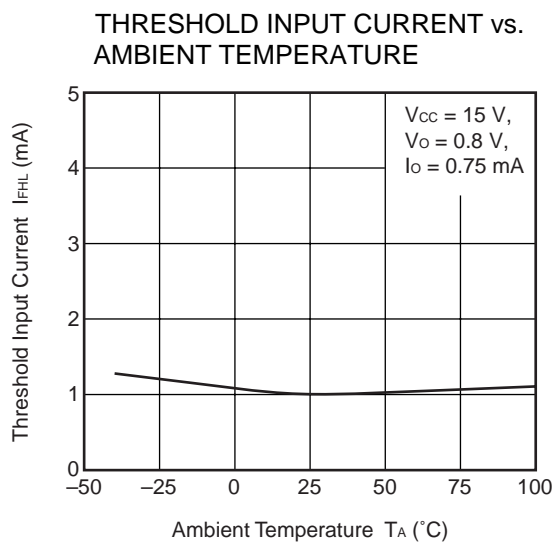
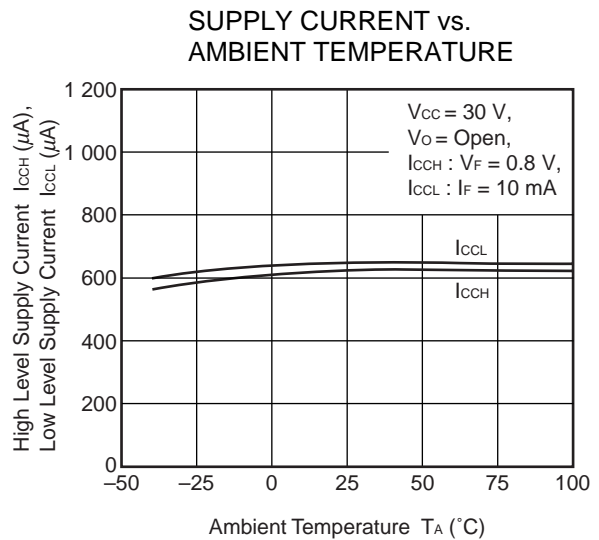
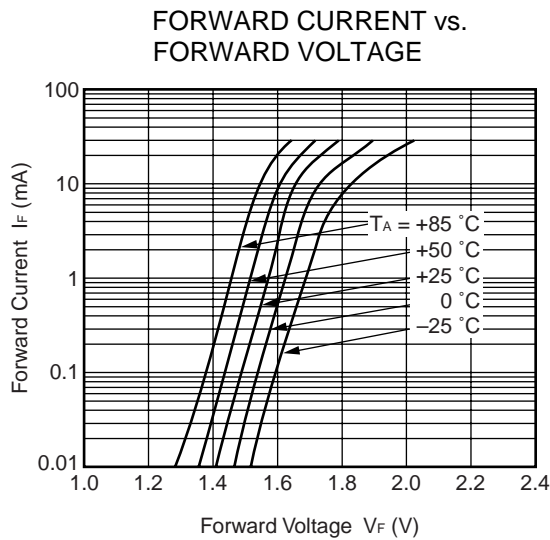
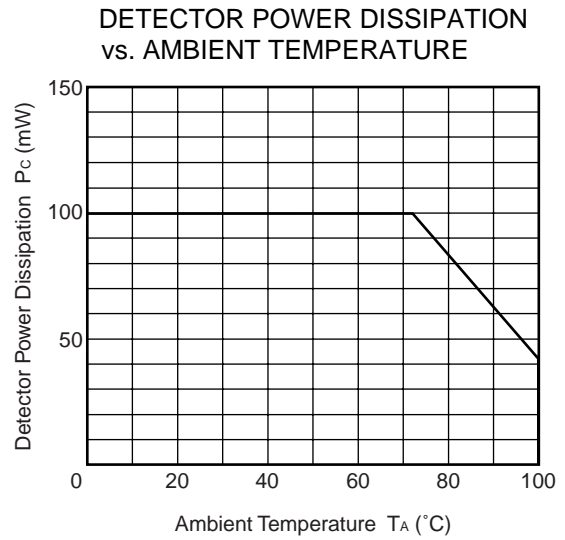
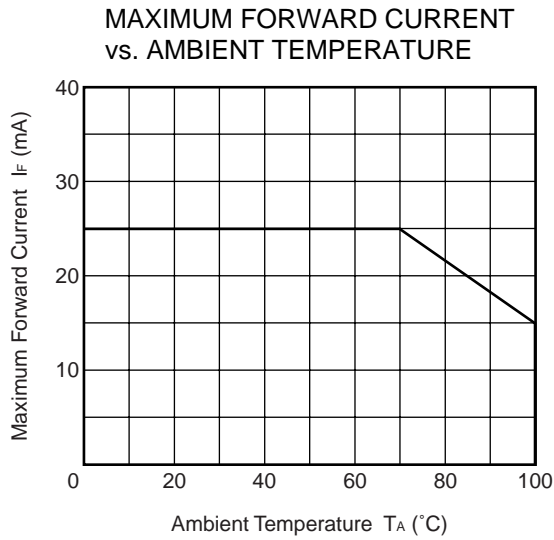

OUTPUT CURRENT vs. FORWARD CURRENT

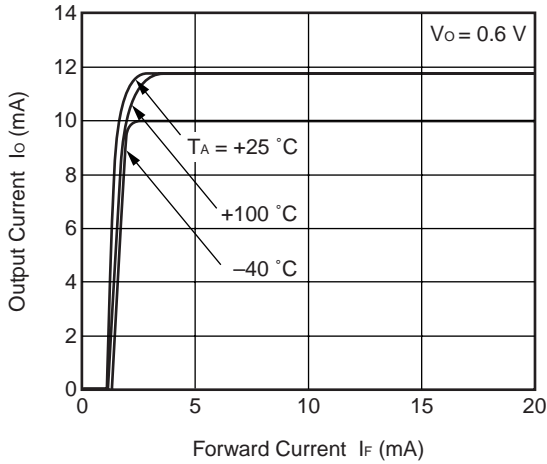

OUTPUT CURRENT vs. AMBIENT TEMPERATURE

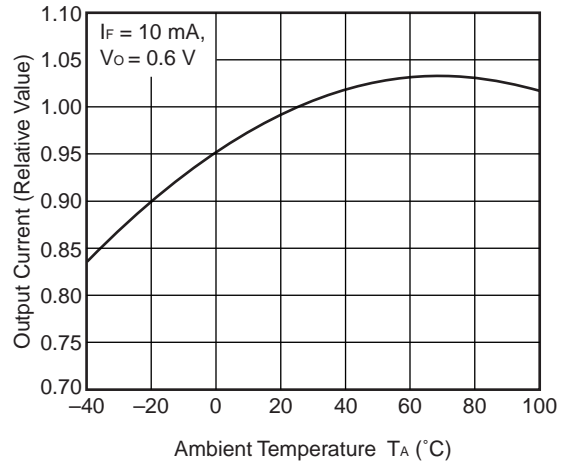

PROPAGATION DELAY TIME, MAXIMUM PROPAGATION DELAYS vs. FORWARD CURRENT

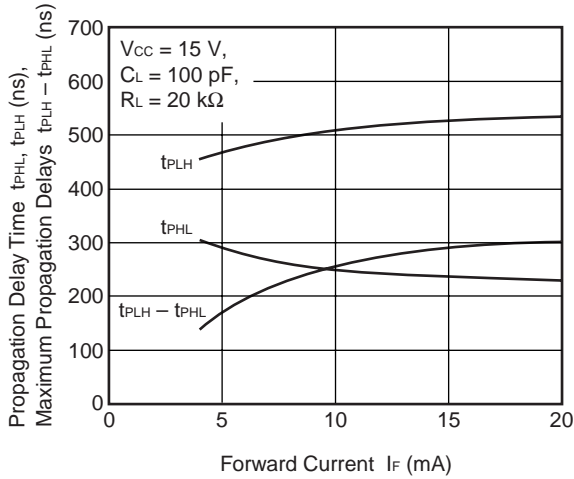

PROPAGATION DELAY TIME, MAXIMUM PROPAGATION DELAYS vs. SUPPLY VOLTAGE

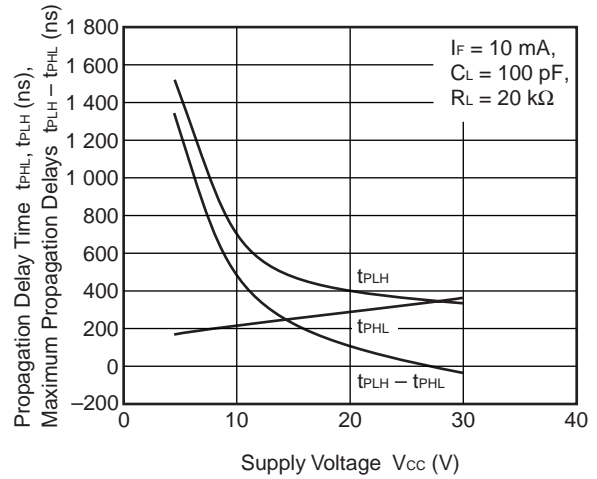

PROPAGATION DELAY TIME, PULSE WIDTH DISTORTION vs. AMBIENT TEMPERATURE

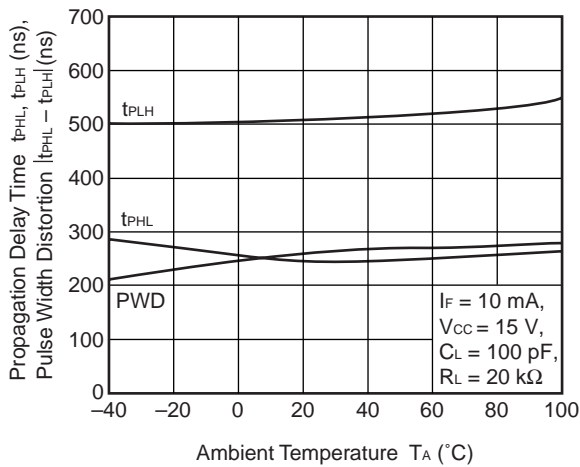

PROPAGATION DELAY TIME vs. LOAD CAPACITANCE

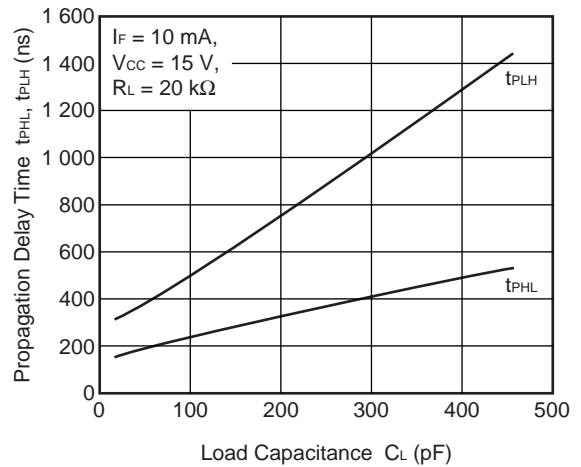

PROPAGATION DELAY TIME,
MAXIMUM PROPAGATION DELAYS
vs. LOAD RESISTANCE

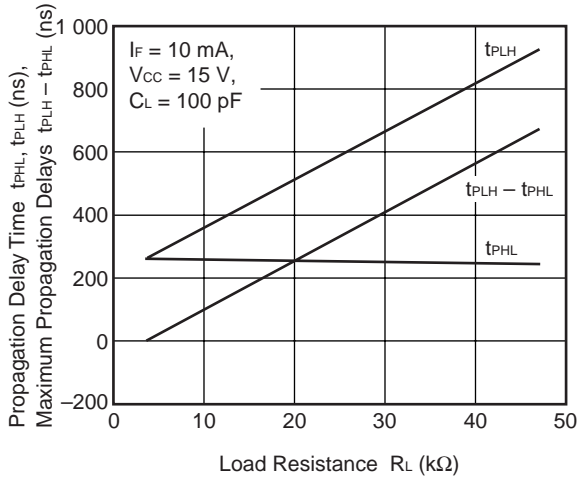

PROPAGATION DELAY TIME,
MAXIMUM PROPAGATION DELAYS
vs. LOAD RESISTANCE

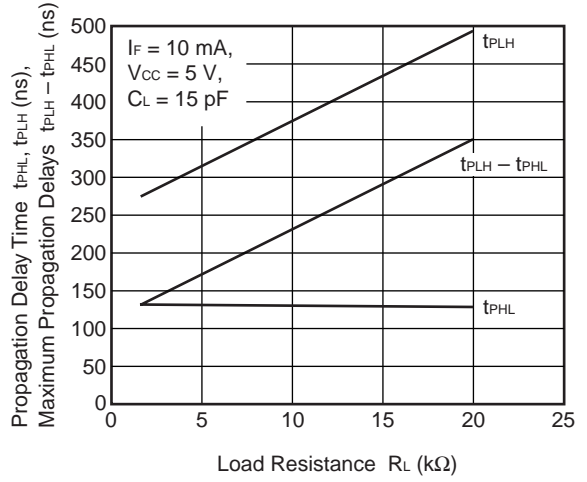

Remark The graphs indicate nominal characteristics.

TAPING SPECIFICATIONS (in millimeters)

Outline and Dimensions (Tape)

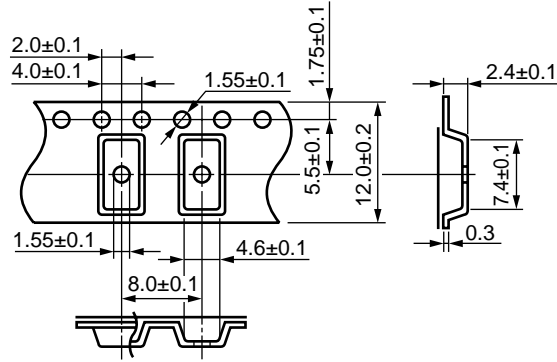

Tape Direction

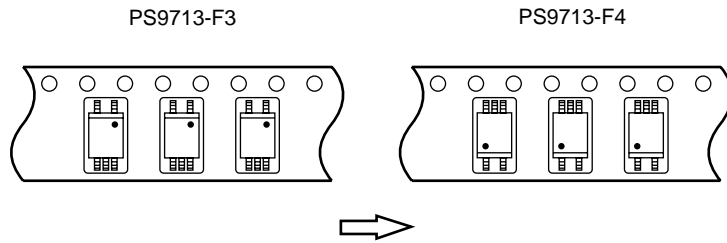

Outline and Dimensions (Reel)

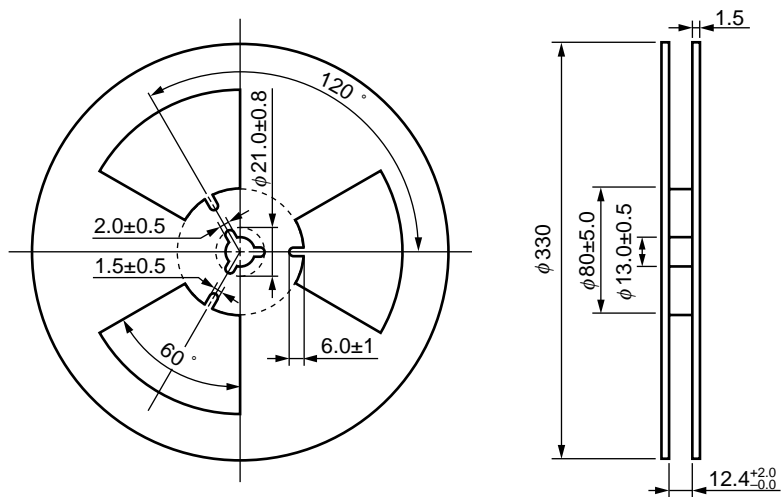

Packing: 3 500 pcs/reel

RECOMMENDED SOLDERING CONDITIONS

(1) Infrared reflow soldering

- Peak reflow temperature 235 °C or below (package surface temperature)
- Time of temperature higher than 210 °C 30 seconds or less
- Number of reflows Three
- Flux Rosin flux containing small amount of chlorine (The flux with a maximum chlorine content of 0.2 Wt % is recommended.)

Recommended Temperature Profile of Infrared Reflow

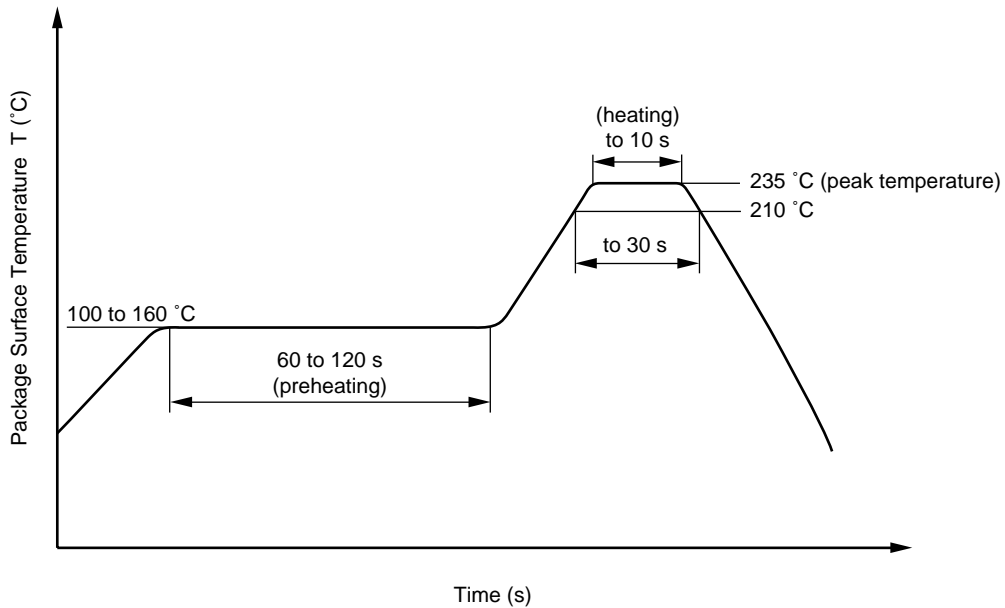

(2) Dip soldering

- Temperature 260 °C or below (molten solder temperature)
- Time 10 seconds or less
- Number of times One (Allowed to be dipped in solder including plastic mold portion.)
- Flux Rosin flux containing small amount of chlorine (The flux with a maximum chlorine content of 0.2 Wt % is recommended.)

(3) Cautions

- Fluxes
Avoid removing the residual flux with freon-based and chlorine-based cleaning solvent.

CAUTION

Within this device there exists GaAs (Gallium Arsenide) material which is a harmful substance if ingested. Please do not under any circumstances break the hermetic seal.

NEPOC is a trademark of NEC Corporation.

- **The information in this document is current as of May, 2000. The information is subject to change without notice. For actual design-in, refer to the latest publications of NEC's data sheets or data books, etc., for the most up-to-date specifications of NEC semiconductor products. Not all products and/or types are available in every country. Please check with an NEC sales representative for availability and additional information.**
 - No part of this document may be copied or reproduced in any form or by any means without prior written consent of NEC. NEC assumes no responsibility for any errors that may appear in this document.
 - NEC does not assume any liability for infringement of patents, copyrights or other intellectual property rights of third parties by or arising from the use of NEC semiconductor products listed in this document or any other liability arising from the use of such products. No license, express, implied or otherwise, is granted under any patents, copyrights or other intellectual property rights of NEC or others.
 - Descriptions of circuits, software and other related information in this document are provided for illustrative purposes in semiconductor product operation and application examples. The incorporation of these circuits, software and information in the design of customer's equipment shall be done under the full responsibility of customer. NEC assumes no responsibility for any losses incurred by customers or third parties arising from the use of these circuits, software and information.
 - While NEC endeavours to enhance the quality, reliability and safety of NEC semiconductor products, customers agree and acknowledge that the possibility of defects thereof cannot be eliminated entirely. To minimize risks of damage to property or injury (including death) to persons arising from defects in NEC semiconductor products, customers must incorporate sufficient safety measures in their design, such as redundancy, fire-containment, and anti-failure features.
 - NEC semiconductor products are classified into the following three quality grades:
"Standard", "Special" and "Specific". The "Specific" quality grade applies only to semiconductor products developed based on a customer-designated "quality assurance program" for a specific application. The recommended applications of a semiconductor product depend on its quality grade, as indicated below. Customers must check the quality grade of each semiconductor product before using it in a particular application.
"Standard": Computers, office equipment, communications equipment, test and measurement equipment, audio and visual equipment, home electronic appliances, machine tools, personal electronic equipment and industrial robots
"Special": Transportation equipment (automobiles, trains, ships, etc.), traffic control systems, anti-disaster systems, anti-crime systems, safety equipment and medical equipment (not specifically designed for life support)
"Specific": Aircraft, aerospace equipment, submersible repeaters, nuclear reactor control systems, life support systems and medical equipment for life support, etc.
- The quality grade of NEC semiconductor products is "Standard" unless otherwise expressly specified in NEC's data sheets or data books, etc. If customers wish to use NEC semiconductor products in applications not intended by NEC, they must contact an NEC sales representative in advance to determine NEC's willingness to support a given application.
- (Note)
- (1) "NEC" as used in this statement means NEC Corporation and also includes its majority-owned subsidiaries.
(2) "NEC semiconductor products" means any semiconductor product developed or manufactured by or for NEC (as defined above).