

ED990714
4702-NVT390-07

AN5539

**Panasonic
MEC IC Div.**

AN5539 is a bipolar monolithic vertical deflection output IC for use in televisions, monitors and displays which are introducing bus control system as IIC. This IC amplifies sawtooth signal processed by previous stage signal processing IC and is able to drive CRT deflection yoke directly.

- < FEATURE >
- Built-in pump-up circuit
 - Built-in thermal protection circuit
 - Single-In-Line 7pin package with fin
 - Introducing dimple formed leads

Maximum Ratings >

supply voltage(pin6)	Vcc6max	30	V
supply voltage(pin3)	Vcc3max	60	V
deflection current	I2max	±1.5	A O-P
thermal resistance	θ_{j-c}	4	°C
maximum power dissipation	Pd	9	W

< Operating Conditions >

recommended supply voltage	Vcc6	24	V
operating supply voltage range	Vcc6 op	10~29	V
recommended deflection current	I2p-p	~2.0	A P-P

< Block Diagram >

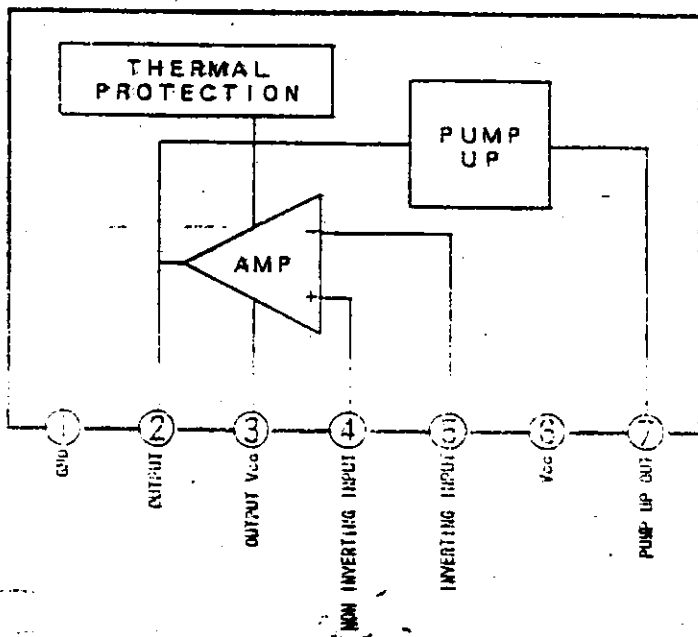

< Package > FP-7S

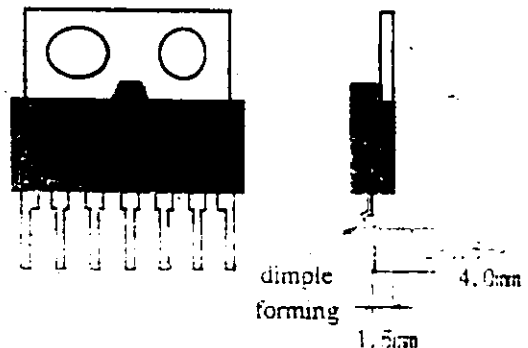

TENTATIVE

PRODUCT STANDARDS

AN5539

total
pages

page

1

Type	Silicon Monolithic Bipolar IC
Package	7-Pin Plastic Package with Fin
Application	TV Vertical Deflection Output Circuit

A Absolute Maximum Ratings						
No.	Parameter	Symbol	Rating	Unit	Note	
1	Storage temperature	Tstg	-55 ~ +150	°C	Note 1	
2	Operating ambient temperature	Topr	-20 ~ +70	°C	Note 1	
3	Operating ambient atmospheric pressure	Popr	$1.013 \times 10^5 \pm 0.61 \times 10^5$ (1.0 ± 0.6)	Pa (atm)		
4	Operating constant gravity	Gopr	9,810 (1,000)	m/S ² (G)		
5	Operating shock	Sopr	4,900 (500)	m/S ² (G)		
6	Supply voltage	Vcc6	30	V		
7	Supply current	Icc6	360	mA		
8	Power dissipation	P _D	1.5	W	Note 2	
9	Circuit voltage	V2-1	0	60	V	
10	Circuit voltage	V3-1	0	60	V	
11	Circuit voltage	V4-1	0	V6-1	V	
12	Circuit voltage	V5-1	0	V6-1	V	
13	Circuit current	I2	-2.2	2.2	A0-P	
14	Circuit current	I7	-1.8	1.8	A0-P	

Operating supply voltage range	Vcc6	12 V ~ 29 V
--------------------------------	------	-------------

Note 1 : The temperature of all parameters shall be Ta=25°C except storage temperature, operating ambient temperature and power dissipation.

Note 2 : The power dissipation shall be at Ta=70°C in free air, without heat sink.
(refer to sheet No.10)

9-FEB-98

PRODUCT STANDARDS

AN5539

 total
pages

page

2

E Electrical Characteristics (Ts=25°C ± 2°C unless otherwise specified)

No.	Parameter	Symbol	Test Circuit	Conditions	Limits			Unit	Note
					min	typ	max		
1	Deflection current	I_{HP-P}	1	Vcc=24V ei=0.2Vrms, 1kHz	1.8	2.0	2.2	A _{p-p}	
2	Vertical amp. distortion	THD _H	1	Vcc=24V ei=0.2Vrms, 1kHz		1.0	3.0	%	
3	Mid-point voltage	V _{MID}	2	Vcc=24V	11	12	13	V	
4	Idling current	I ₃	2	Vcc=24V	10	20	30	mA	
5	Output saturation voltage (Lower)	V ₂₋₁	3	Vcc=24V I ₂ =0.9A		1.5	2.2	V	
6	Output saturation voltage (Upper)	V ₃₋₂	4	Vcc=24V I ₂ =-0.9A		2.9	3.7	V	
7	Pump-up charge saturation voltage	V ₇₋₁	5	Vcc=24V I ₇ =20mA		0.2	0.5	V	
8	Pump-up discharge saturation voltage	V ₆₋₇	6	Vcc=24V I ₇ =-0.9A		2.2	2.9	V	

Test Circuit-1 (Deflection current , Vertical amp. distortion)

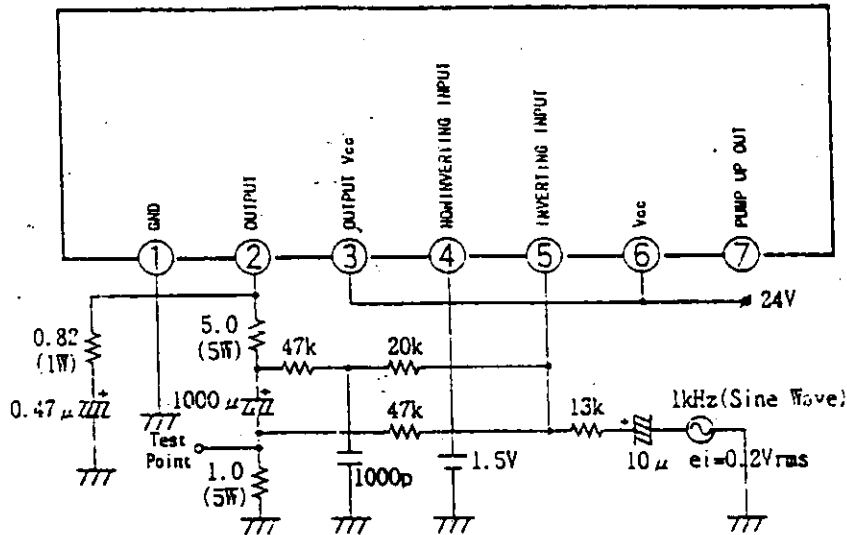

Test Circuit-2 (Mid-point voltage , Idling current)

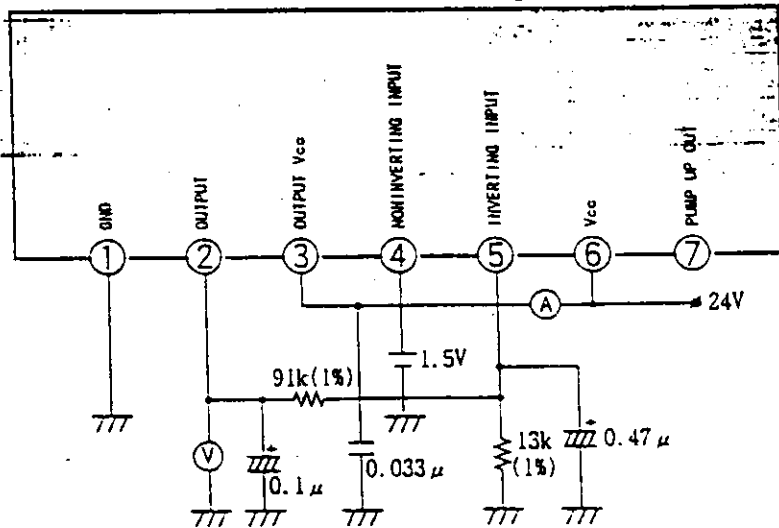

Test Circuit-3 (Output saturation voltage (Lower))

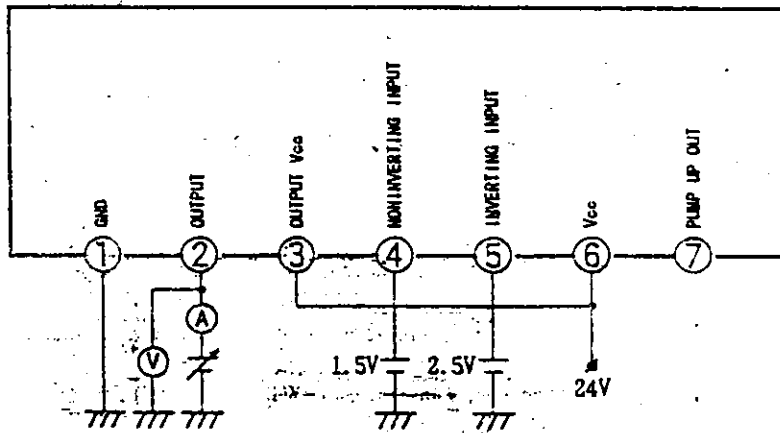

Monitor the voltage when the current is 0.9A.

Test Circuit-4 (Output saturation voltage (Upper))

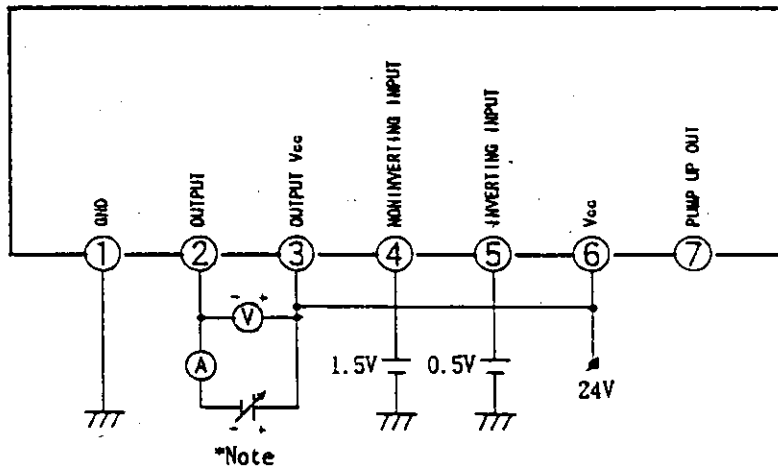

Monitor the voltage when the current is 0.9A.

*Note : In case an external power supply is used, set the GND terminal open(floating).

Test Circuit-5 (Pump-up charge saturation voltage)

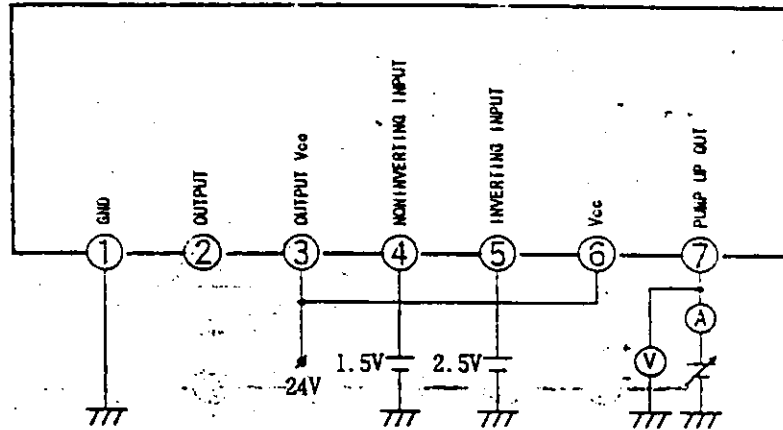

Monitor the voltage when the current is 20mA.

Test Circuit-6 (Pump-up discharge saturation voltage)

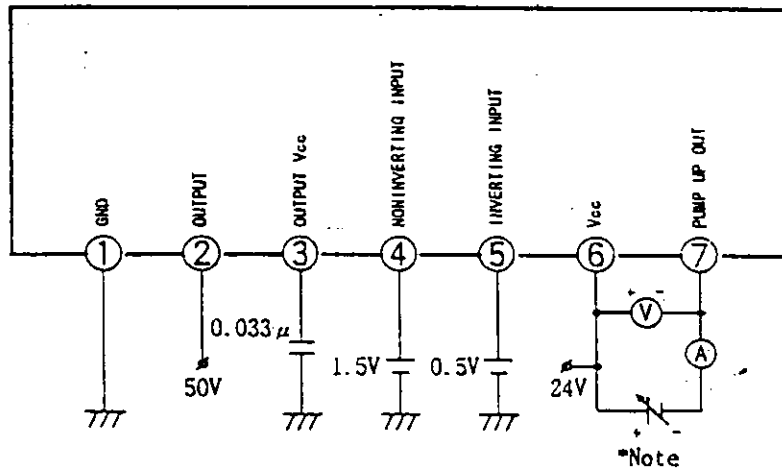

*Note

Monitor the voltage when the current is 0.9A.

*Note : In case an external power supply is used, set the GND terminal open(floating).

[Block Diagram]

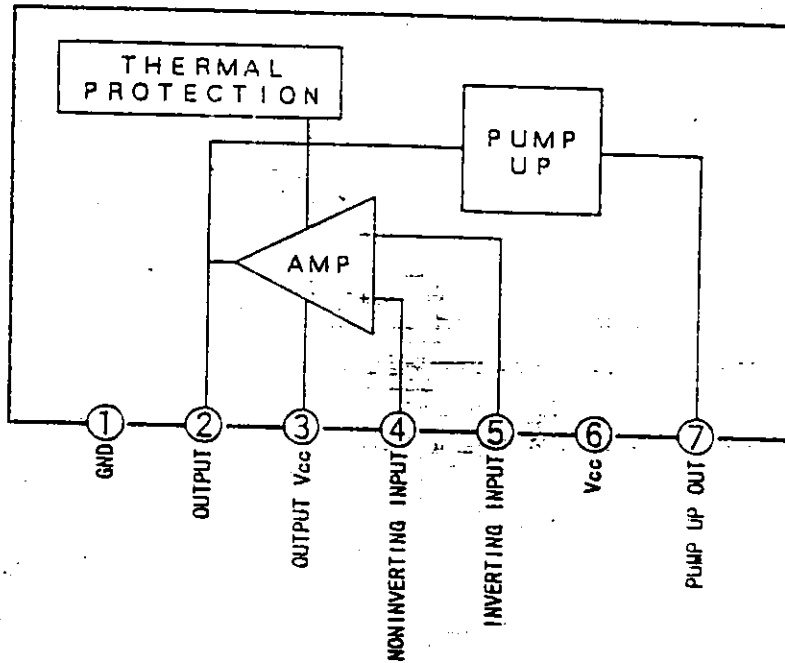

[Pin Assignment]

Pin No.	Pin Description
1	GND
2	Vertical output
3	Vertical output power supply
4	Noninverting input
5	Inverting input
6	Power supply
7	Pump-up output

Package Name

FP-7S

Tentative

Unit : mm

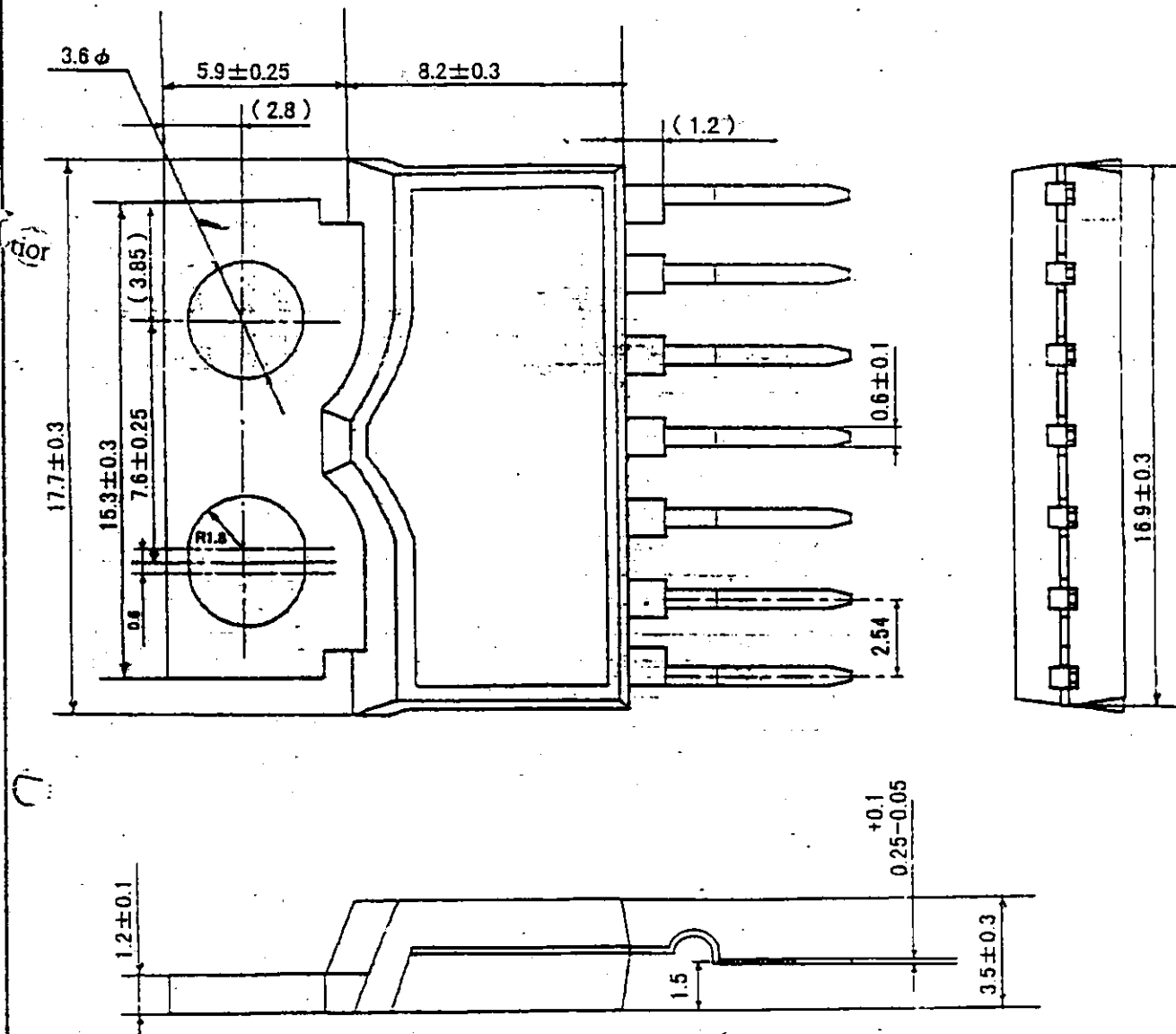

() : Reference data

PRODUCT STANDARDS

AN5539

total
pages

page

8

Tentative

Package Name

FP-7S

Country
of origin

Date code

Part No.

Logo

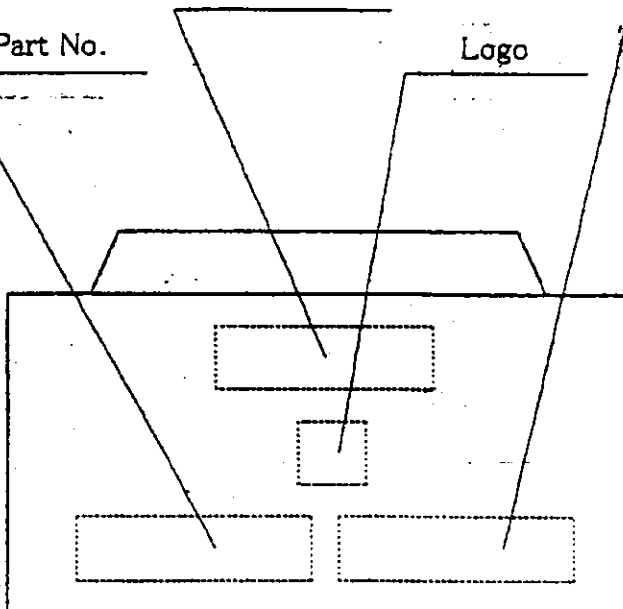

[Structure]

Chip surface passivation	PSG	①
Lead frame material	Cu group	②, ⑥
Internal lead surface treatment	Ag plating	②
External lead surface treatment	Solder dip	⑥
Chip mounting method	Solder	③
Wire bonding method	Thermosonic bonding	④
Wire material, diameter	Au , Diameter : 38 μ m	④
Mold material	Epoxy	⑤
Molding method	Transfer mold	⑤

< Package >

FP-7S

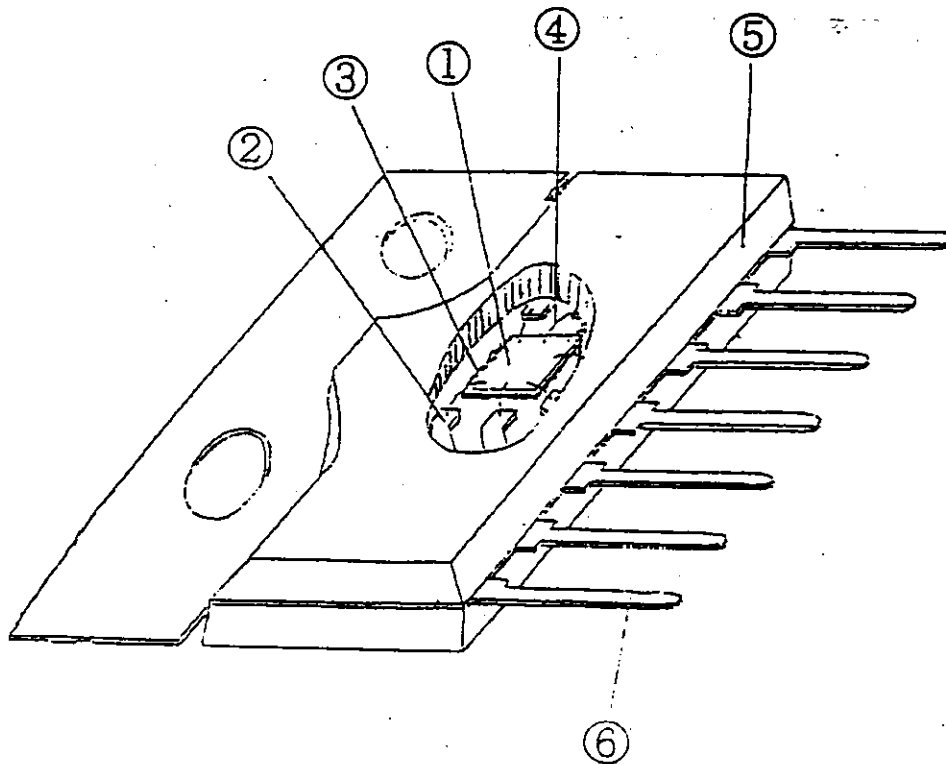

< Pin Description >

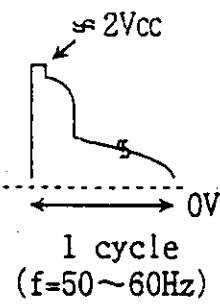
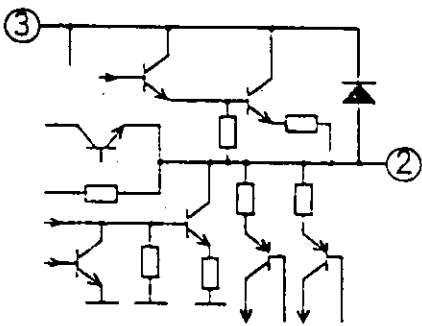
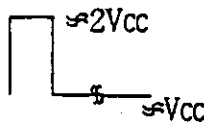
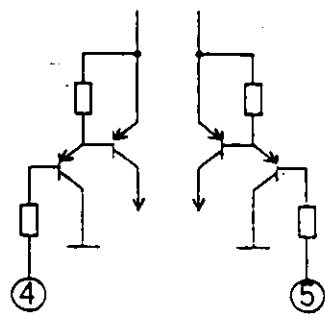
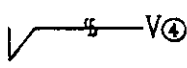
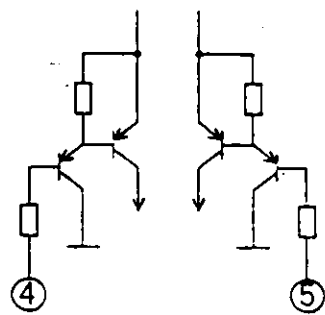
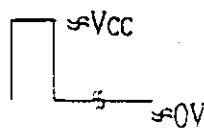
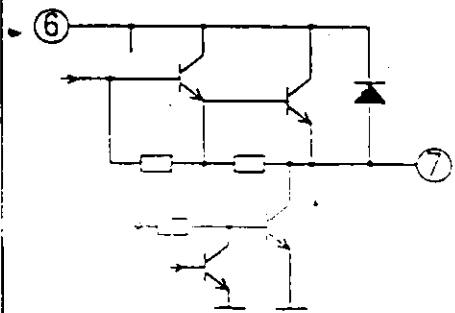
Pin No.	Pin Name	Signal Wave Form	Description	Equivalent Circuit
①	GND	DC	—	—
②	Vertical Output		A vertical deflection coil is connected and 1~2A of deflection current is provided through the pin.	
③	Vertical Output Power Supply		About $V_{cc} \times 2$ for flyback period and $V_{cc} - V_D$ for the other period are supplied.	—
④	Noninverting Input	DC (External Bias)	About 2V is supplied. Very high sensitivity may cause abnormal oscillation.	
⑤	Inverting Input		Input signal and CR network for feedback are connected. Very high sensitivity.	
⑥	Power supply (Vcc)	DC	10~29V is supplied.	—
⑦	Pump-up Output		A capacitor connected between this pin and pin③ is charged and discharge during flyback pulse in order to supply about $V_{cc} \times 2$ to pin③.	

FP-7S Ambient Temperature (T_a) vs Power Dissipation (P_D)

Tentative

- ① Without heat sink : $R_{th(j-a)} = 53.2^\circ\text{C/W}$
- ② Infinite heat sink : $R_{th(j-c)} = 4^\circ\text{C/W}$

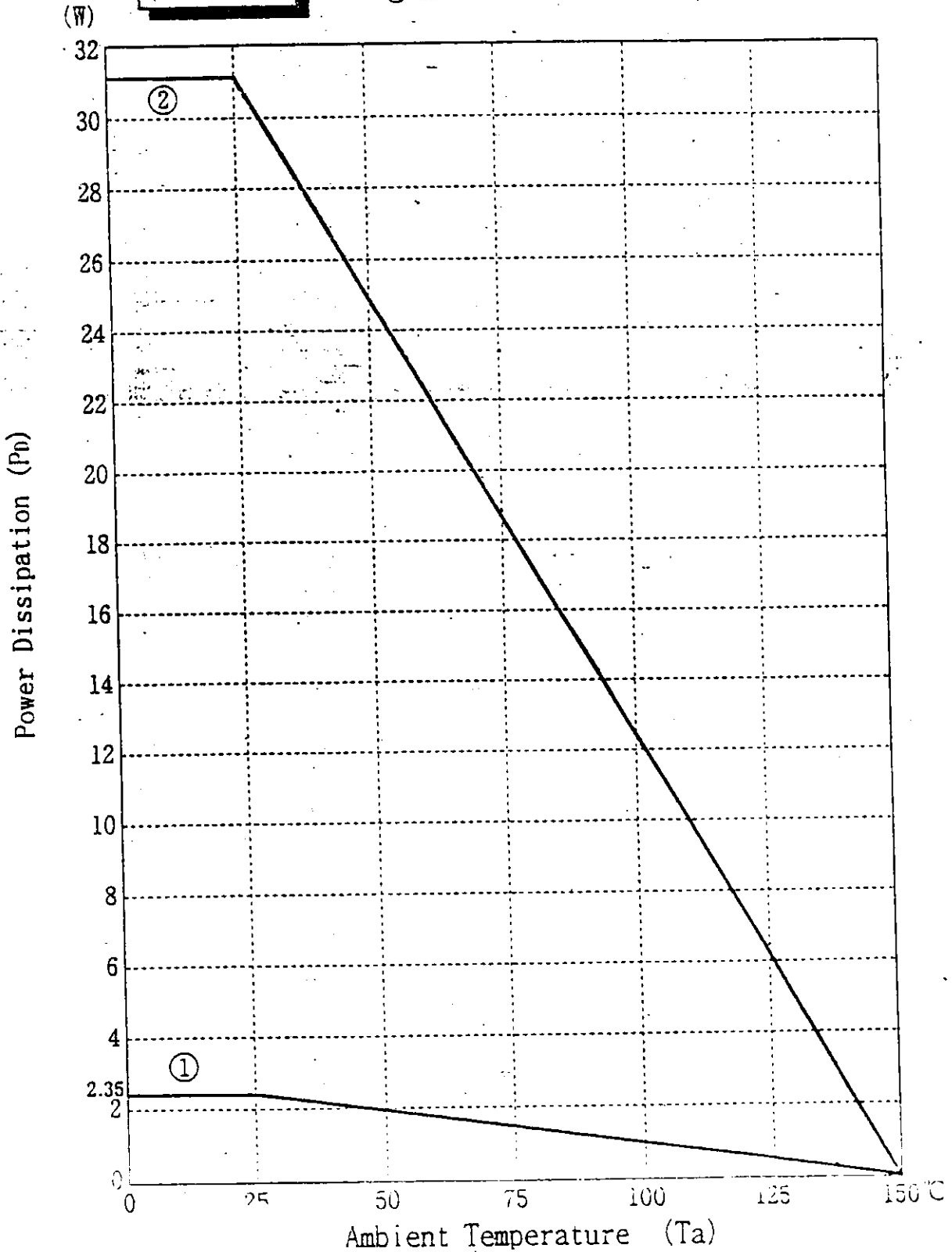

Output Transister Forward Bias ASO(Area of Safe Operation)

Tentative

Ta=25°C
Single Pulse

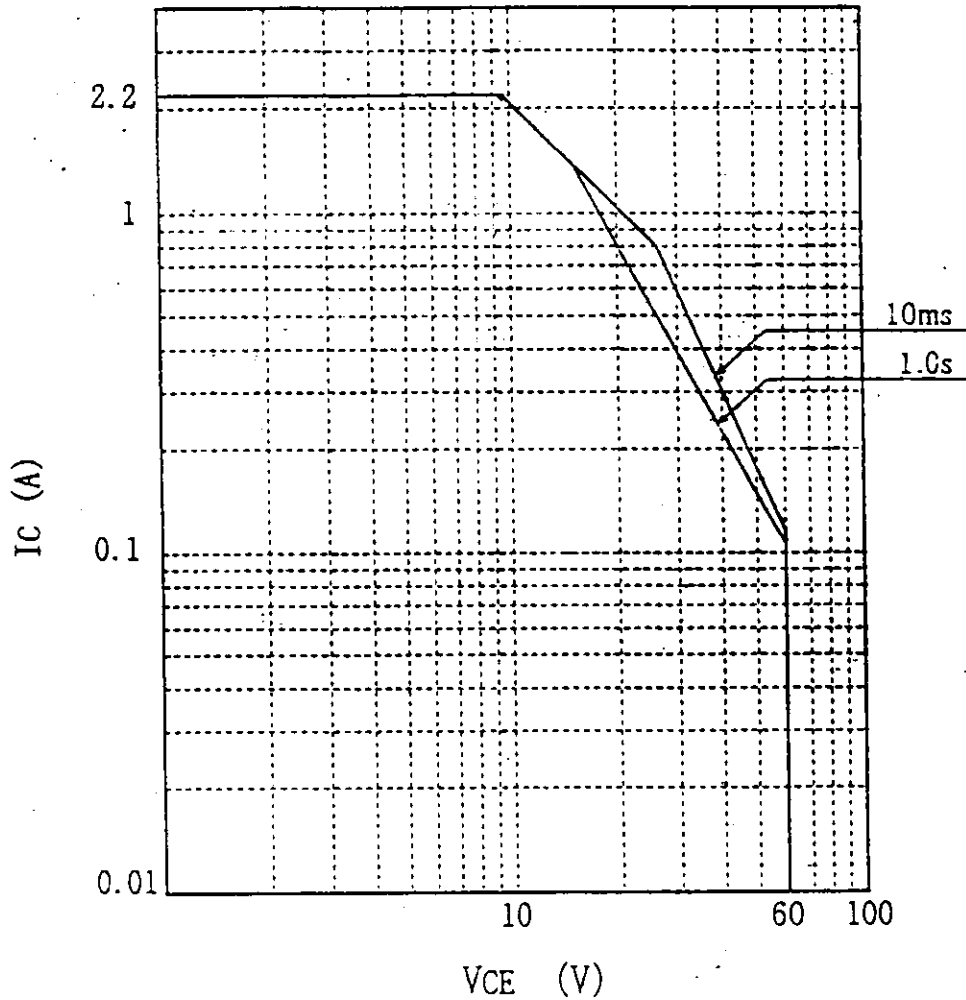

Note : The max. deflection current value suitable for practical use is within $\pm 1.5A_0-P(3AP-P)$

< Application Circuit >

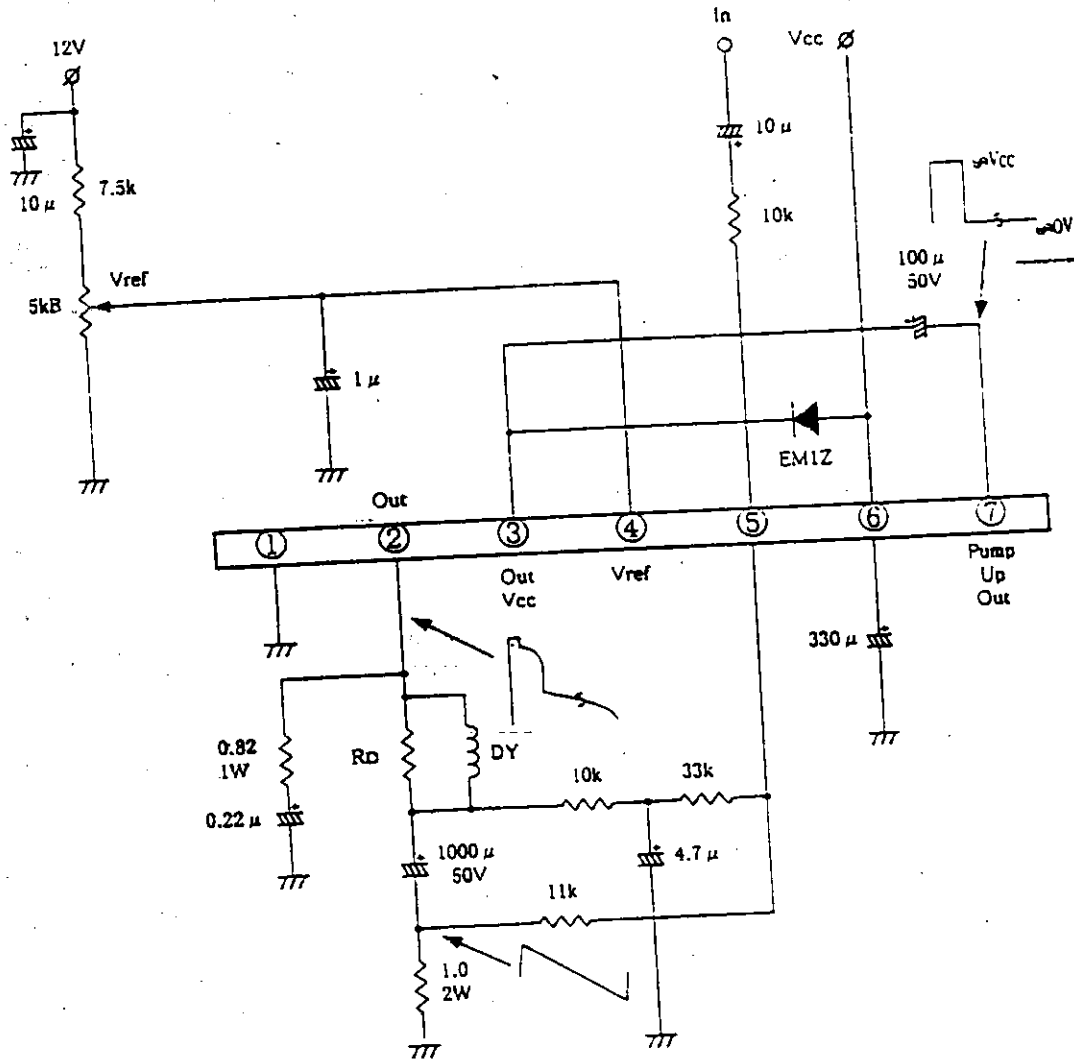

< Precautions for application >

Test result of short between pins

Test condition : Vcc=30V
DC Power Supply(30V, 5A)

1							
2	×						
3	⊗	×					
4	○	○	○				
5	○	○	○	○			
6	⊗	○	○	○	○		
7	○	○	○	○	○	○	
Pin No.	1	2	3	4	5	6	7

○ : No destruction of IC

× : Destruction of IC

⊗ : No destruction of IC but possible damage of external power supply

※ : A short circuit between pin2(Vertical output) and pin1(GND) or between pin2 and pin3(Vertical output power supply) may cause IC destruction. After the destruction, continuous supply of Vcc may cause smoke from the IC. Therefore full attention should be paid when this IC is used. For example, some external current limiter like a small resistor should be connected to pin6.