

NPN Silicon RF Transistor

- For low noise, low-power amplifiers in mobile communication systems (pager, cordless telephone) at collector currents from 0.2mA to 8mA
- $f_T = 7.5\text{GHz}$
 $F = 1.5\text{dB}$ at 900MHz



ESD: Electrostatic discharge sensitive device, observe handling precaution!

Type	Marking	Ordering Code	Pin Configuration			Package
BFR 280	REs	Q62702-F1298	1 = B	2 = E	3 = C	SOT-23

Maximum Ratings

Parameter	Symbol	Values	Unit
Collector-emitter voltage	V_{CEO}	8	V
Collector-emitter voltage	V_{CES}	10	
Collector-base voltage	V_{CBO}	10	
Emitter-base voltage	V_{EBO}	2	
Collector current	I_C	10	mA
Base current	I_B	1.2	
Total power dissipation $T_S \leq 115\text{ °C}$	P_{tot}	80	mW
Junction temperature	T_j	150	°C
Ambient temperature	T_A	- 65 ... + 150	
Storage temperature	T_{stg}	- 65 ... + 150	

Thermal Resistance

Junction - soldering point ¹⁾	R_{thJS}	≤ 425	K/W
--	------------	------------	-----

1) T_S is measured on the collector lead at the soldering point to the pcb.

Electrical Characteristics at $T_A = 25^\circ\text{C}$, unless otherwise specified.

Parameter	Symbol	Values			Unit
		min.	typ.	max.	
DC Characteristics					
Collector-emitter breakdown voltage $I_C = 1 \text{ mA}, I_B = 0$	$V_{(BR)CEO}$	8	-	-	V
Collector-emitter cutoff current $V_{CE} = 10 \text{ V}, V_{BE} = 0$	I_{CES}	-	-	100	μA
Collector-base cutoff current $V_{CB} = 8 \text{ V}, I_E = 0$	I_{CBO}	-	-	100	nA
Emitter-base cutoff current $V_{EB} = 1 \text{ V}, I_C = 0$	I_{EBO}	-	-	1	μA
DC current gain $I_C = 3 \text{ mA}, V_{CE} = 5 \text{ V}$	h_{FE}	30	100	200	-

Electrical Characteristics at $T_A = 25^\circ\text{C}$, unless otherwise specified.

Parameter	Symbol	Values			Unit
		min.	typ.	max.	
AC Characteristics					
Transition frequency $I_C = 6 \text{ mA}, V_{CE} = 5 \text{ V}, f = 500 \text{ MHz}$	f_T	5	7.5	-	GHz
Collector-base capacitance $V_{CB} = 5 \text{ V}, f = 1 \text{ MHz}$	C_{cb}	-	0.27	0.45	pF
Collector-emitter capacitance $V_{CE} = 5 \text{ V}, f = 1 \text{ MHz}$	C_{ce}	-	0.18	-	
Emitter-base capacitance $V_{EB} = 0.5 \text{ V}, f = 1 \text{ MHz}$	C_{eb}	-	0.22	-	
Noise figure $I_C = 1.5 \text{ mA}, V_{CE} = 5 \text{ V}, Z_S = Z_{Sopt}$ $f = 900 \text{ MHz}$ $f = 1.8 \text{ GHz}$	F	- -	1.5 2	- -	dB
Power gain ¹⁾ $I_C = 3 \text{ mA}, V_{CE} = 5 \text{ V}, Z_S = Z_{Sopt}$ $Z_L = Z_{Lopt}$ $f = 900 \text{ MHz}$ $f = 1.8 \text{ GHz}$	G_{ms}	- -	17 11.5	- -	
Transducer gain $I_C = 3 \text{ mA}, V_{CE} = 5 \text{ V}, Z_S = Z_L = 50 \Omega$ $f = 900 \text{ MHz}$ $f = 1.8 \text{ GHz}$	$ S_{21e} ^2$	- -	13 8	- -	

1) $G_{ms} = |S_{21}/S_{12}|$

SPICE Parameters (Gummel-Poon Model, Berkeley-SPICE 2G.6 Syntax) :

Transistor Chip Data

IS =	6.472	fA	BF =	89.888	-	NF =	1.0801	-
VAF =	25.609	V	IKF =	0.073457	A	ISE =	15.596	fA
NE =	1.6163	-	BR =	20.238	-	NR =	0.83403	-
VAR =	5.6909	V	IKR =	0.012696	A	ISC =	1.409	fA
NC =	1.0651	-	RB =	15	Ω	IRB =	0.031958	mA
RBM =	14.999	Ω	RE =	2.4518	Ω	RC =	6.989	Ω
CJE =	36.218	fF	VJE =	0.70035	V	MJE =	0.69773	-
TF =	11.744	ps	XTF =	0.21585	-	VTF =	0.2035	V
ITF =	6.2179	mA	PTF =	0	deg	CJC =	252.99	fF
VJC =	1.1943	V	MJC =	0.30017	-	XCJC =	0.19188	-
TR =	2.3693	ns	CJS =	0	fF	VJS =	0.75	V
MJS =	0	-	XTB =	0	-	EG =	1.11	eV
XTI =	3	-	FC =	0.96275	-	TNOM	300	K

All parameters are ready to use, no scaling is necessary.

Extracted on behalf of SIEMENS Small Signal Semiconductors by:

Institut für Mobil-und Satellitenfunktechnik (IMST)

© 1996 SIEMENS AG

Package Equivalent Circuit:

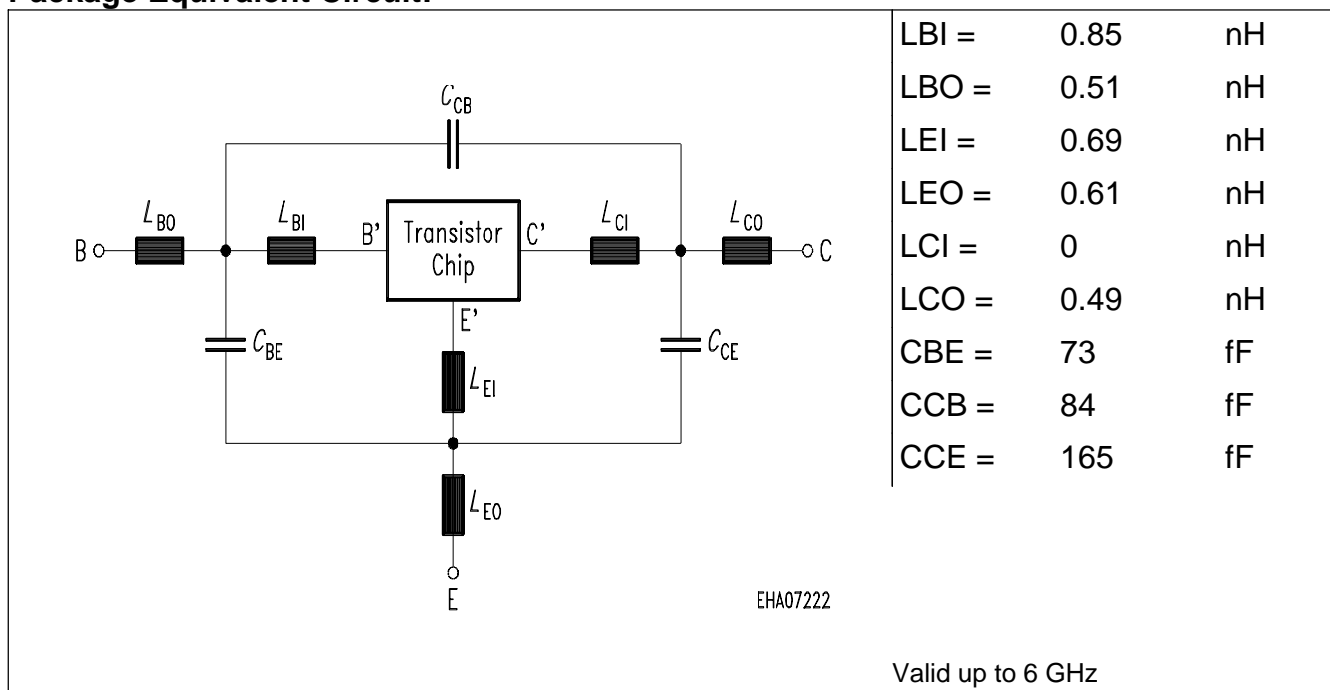

For examples and ready to use parameters please contact your local Siemens distributor or sales office to obtain a Siemens CD-ROM or see Internet: <http://www.siemens.de/Semiconductor/products/35/35.htm>

Total power dissipation $P_{tot} = f(T_A^*, T_S)$

* Package mounted on epoxy

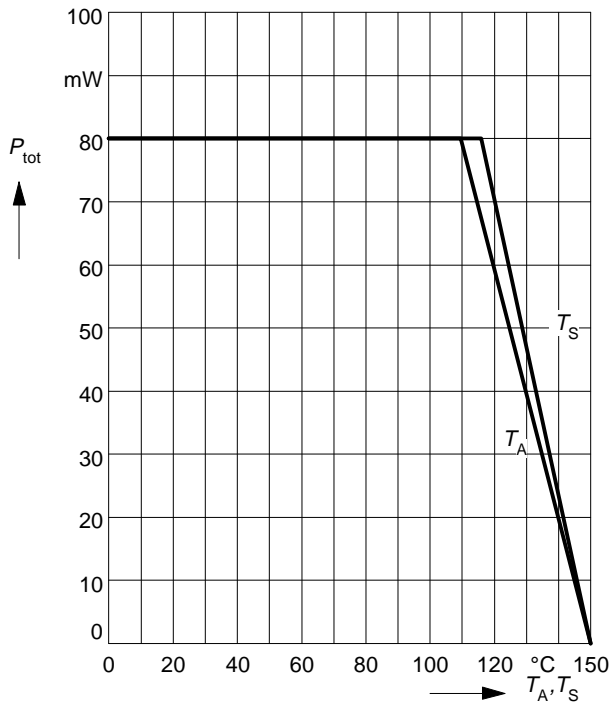

Permissible Pulse Load $R_{thJS} = f(t_p)$

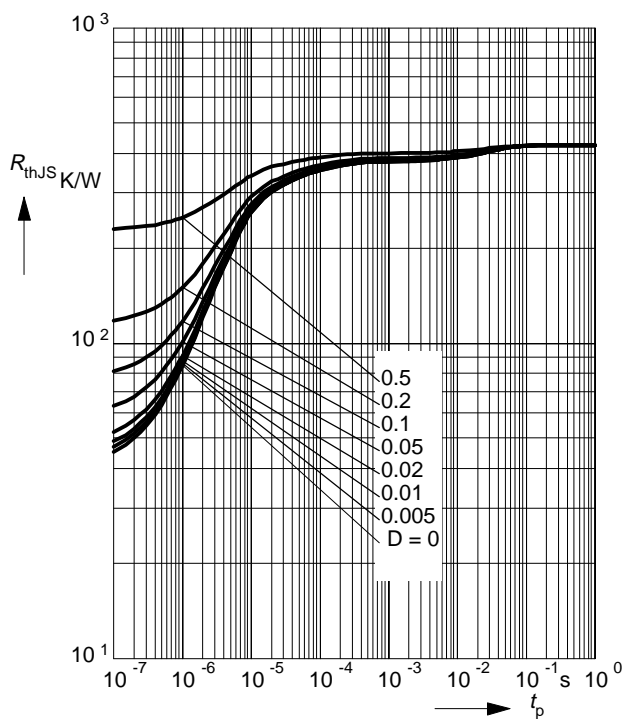

Permissible Pulse Load $P_{totmax}/P_{totDC} = f(t_p)$

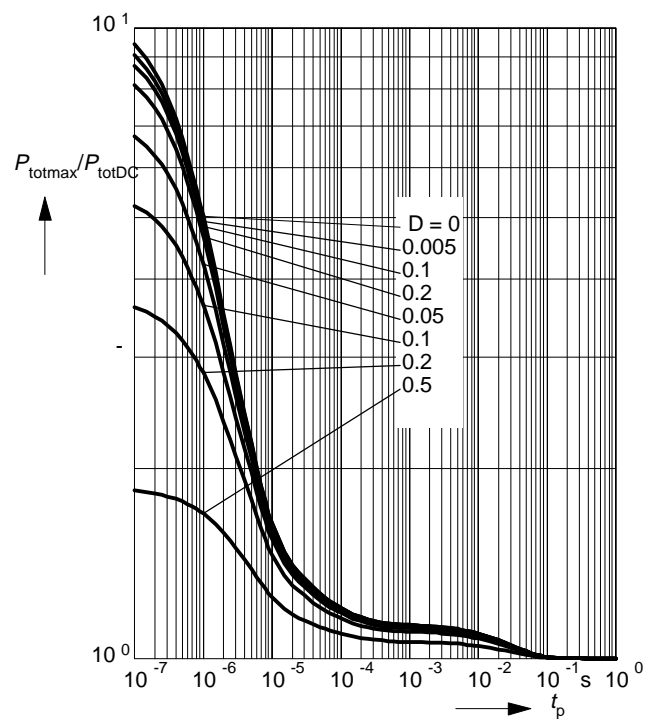

Collector-base capacitance $C_{cb} = f(V_{CB})$

$V_{BE} = v_{be} = 0, f = 1\text{MHz}$

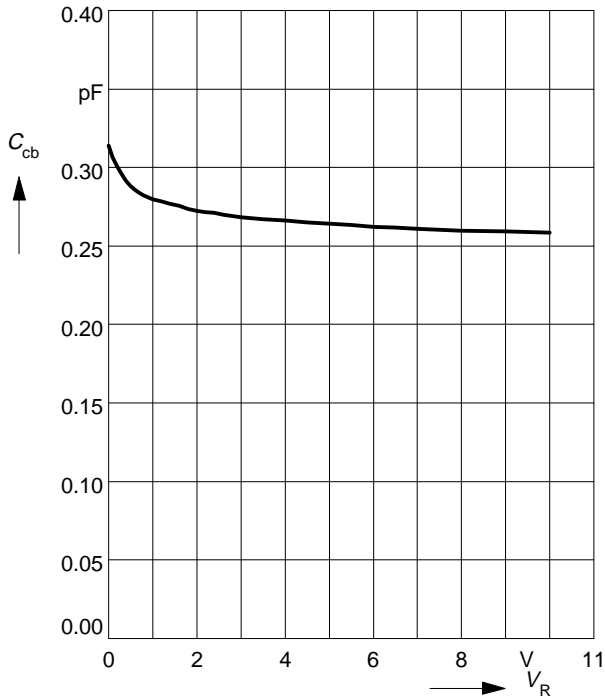

Transition frequency $f_T = f(I_C)$

$V_{CE} = \text{Parameter}$

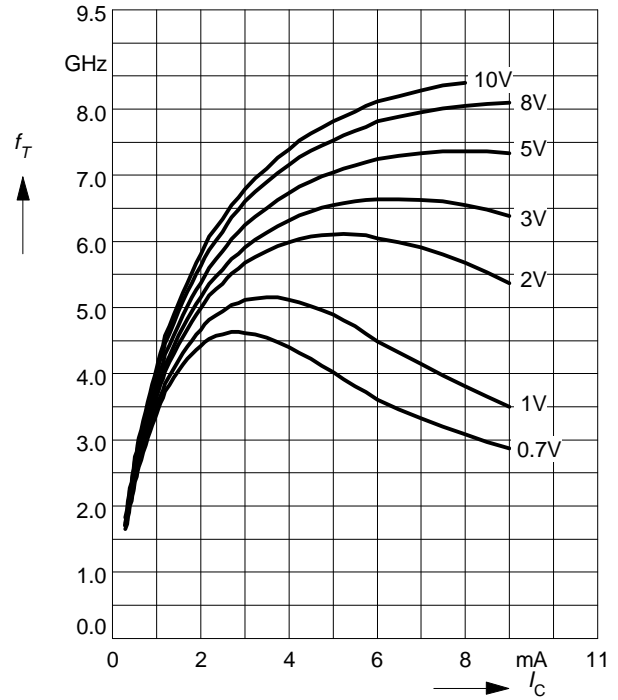

Power Gain $G_{ma}, G_{ms} = f(I_C)$

$f = 0.9\text{GHz}$

$V_{CE} = \text{Parameter}$

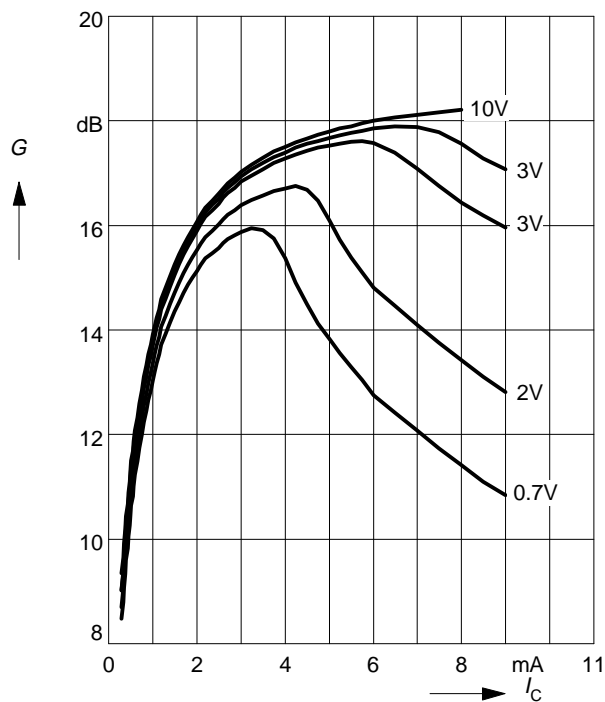

Power Gain $G_{ma}, G_{ms} = f(I_C)$

$f = 1.8\text{GHz}$

$V_{CE} = \text{Parameter}$

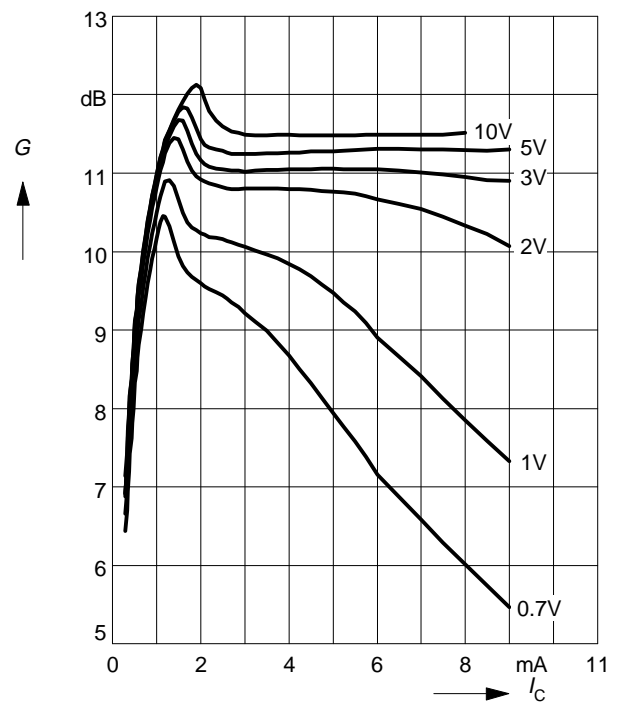

Power Gain $G_{ma}, G_{ms} = f(V_{CE})$: _____
 $|S_{21}|^2 = f(V_{CE})$: - - - - -

$f =$ Parameter

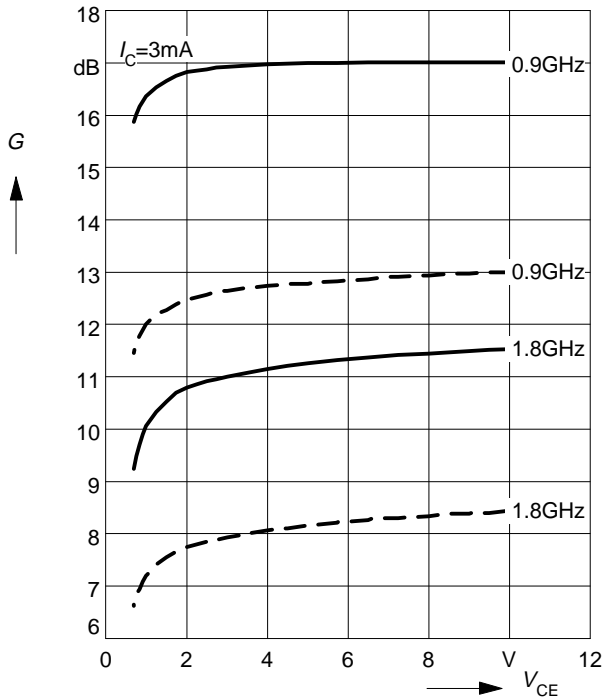

Intermodulation Intercept Point $IP_3 = f(I_C)$
 (3rd order, Output, $Z_S = Z_L = 50\Omega$)

$V_{CE} =$ Parameter, $f = 900\text{MHz}$

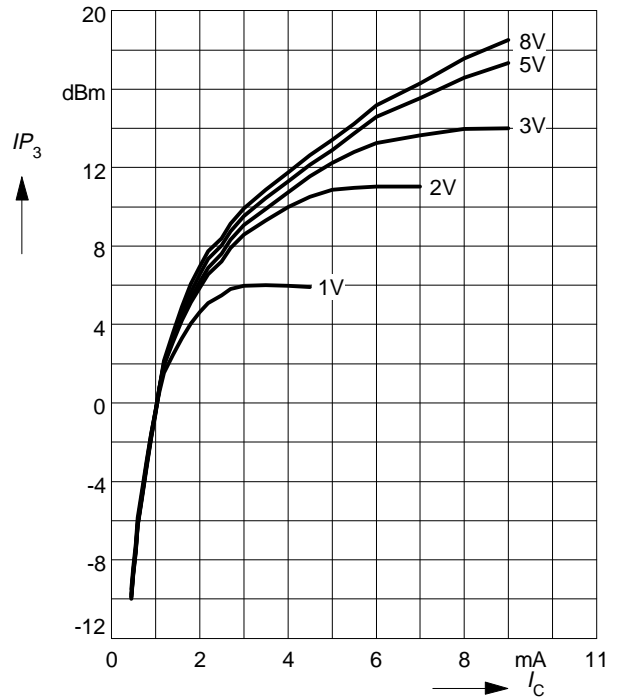

Power Gain $G_{ma}, G_{ms} = f(f)$

$V_{CE} =$ Parameter

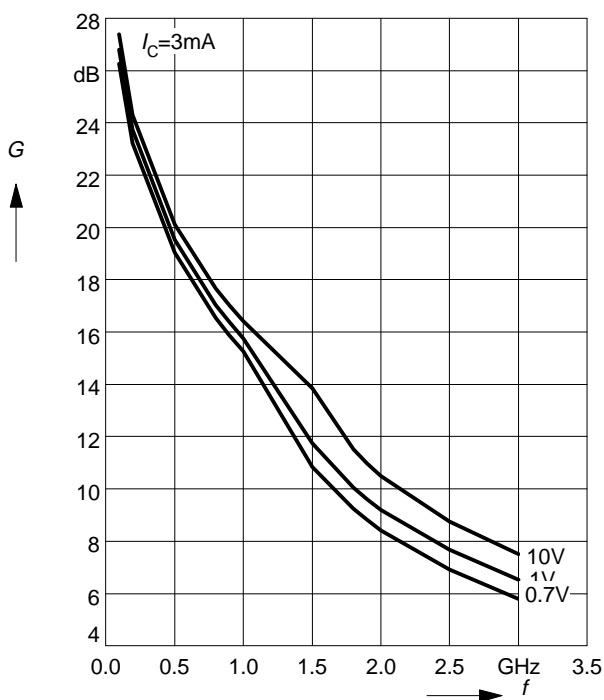

Power Gain $|S_{21}|^2 = f(f)$

$V_{CE} =$ Parameter

