

HAT2033R/HAT2033RJ

Silicon N Channel Power MOS FET
High Speed Power Switching

HITACHI

ADE-208-664B (Z)
3rd. Edition
February 1999

Features

- For Automotive Application (at Type Code “J “)
- Low on-resistance
- Capable of 4 V gate drive
- High density mounting

Outline

SOP-8

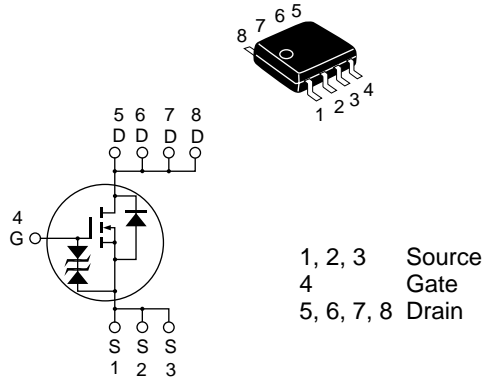

Absolute Maximum Ratings ($T_a = 25^\circ\text{C}$)

Item		Symbol	Ratings	Unit
Drain to source voltage		V_{DSS}	60	V
Gate to source voltage		V_{GSS}	± 20	V
Drain current		I_D	7	A
Drain peak current		$I_{D(pulse)}$ ^{Note1}	56	A
Body-drain diode reverse drain current		I_{DR}	7	A
Avalanche current	HAT2033R	I_{AP} ^{Note4}	—	—
	HAT2033RJ		7	A
Avalanche energy	HAT2033R	E_{AR} ^{Note4}	—	—
	HAT2033RJ		4.2	mJ
Channel dissipation		P_{ch} ^{Note2}	2.5	W
Channel temperature		T_{ch}	150	$^\circ\text{C}$
Storage temperature		T_{stg}	- 55 to + 150	$^\circ\text{C}$

- Note:
1. $PW \leq 10\mu\text{s}$, duty cycle $\leq 1\%$
 2. When using the glass epoxy board (FR4 40 x 40 x 1.6 mm), $PW \leq 10\text{s}$
 3. Value at $T_{ch}=25^\circ\text{C}$, $R_g \geq 50\Omega$

Electrical Characteristics (Ta = 25°C)

Item		Symbol	Min	Typ	Max	Unit	Test Conditions
Drain to source breakdown voltage		$V_{(BR)DSS}$	60	—	—	V	$I_D = 10 \text{ mA}, V_{GS} = 0$
Gate to source breakdown voltage		$V_{(BR)GSS}$	± 20	—	—	V	$I_G = \pm 100 \text{ }\mu\text{A}, V_{DS} = 0$
Gate to source leak current		I_{GSS}	—	—	± 10	μA	$V_{GS} = \pm 16 \text{ V}, V_{DS} = 0$
Zero gate voltage	HAT2033R	I_{DSS}	—	—	1	μA	$V_{DS} = 60 \text{ V}, V_{GS} = 0$
drain current	HAT2033RJ	I_{DSS}	—	—	0.1	μA	
Zero gate voltage	HAT2033R	I_{DSS}	—	—	—	μA	$V_{DS} = 4 \text{ 8V}, V_{GS} = 0$
drain current	HAT2033RJ	I_{DSS}	—	—	10	μA	Ta = 125°C
Gate to source cutoff voltage		$V_{GS(off)}$	1.2	—	2.2	V	$V_{DS} = 10 \text{ V}, I_D = 1 \text{ mA}$
Static drain to source on state		$R_{DS(on)}$	—	0.03	0.038	Ω	$I_D = 4 \text{ A}, V_{GS} = 10 \text{ V}$ ^{Note4}
resistance		$R_{DS(on)}$	—	0.04	0.053	Ω	$I_D = 4 \text{ A}, V_{GS} = 4 \text{ V}$ ^{Note4}
Forward transfer admittance		$ y_{fs} $	6.5	10	—	S	$I_D = 4 \text{ A}, V_{DS} = 10 \text{ V}$ ^{Note4}
Input capacitance		Ciss	—	740	—	pF	$V_{DS} = 10 \text{ V}$
Output capacitance		Coss	—	370	—	pF	$V_{GS} = 0$
Reverse transfer capacitance		Crss	—	130	—	pF	f = 1MHz
Turn-on delay time		$t_{d(on)}$	—	13	—	ns	$V_{GS} = 10 \text{ V}, I_D = 4 \text{ A}$
Rise time		t_r	—	55	—	ns	$V_{DD} \cong 30 \text{ V}$
Turn-off delay time		$t_{d(off)}$	—	140	—	ns	
Fall time		t_f	—	95	—	ns	
Body–drain diode forward voltage		V_{DF}	—	0.82	1.07	V	$I_F = 7 \text{ A}, V_{GS} = 0$ ^{Note4}
Body–drain diode reverse recovery time		t_{rr}	—	45	—	ns	$I_F = 7 \text{ A}, V_{GS} = 0$ $diF/dt = 50 \text{ A}/\mu\text{s}$

Note: 4. Pulse test

Main Characteristics

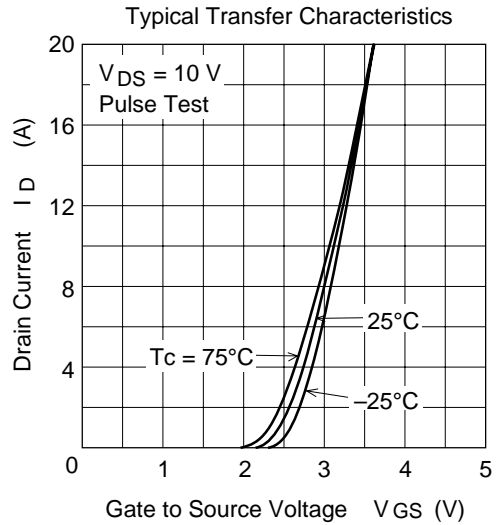
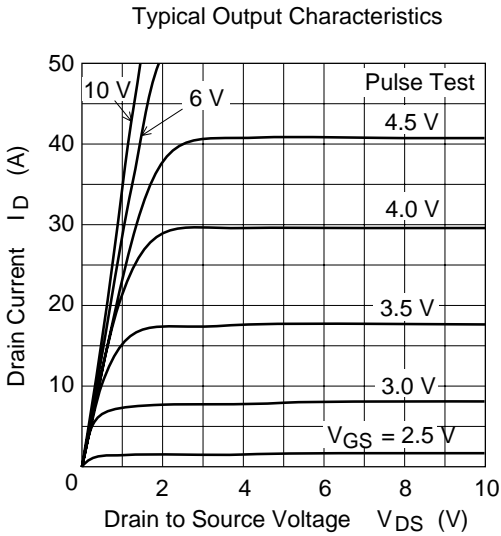
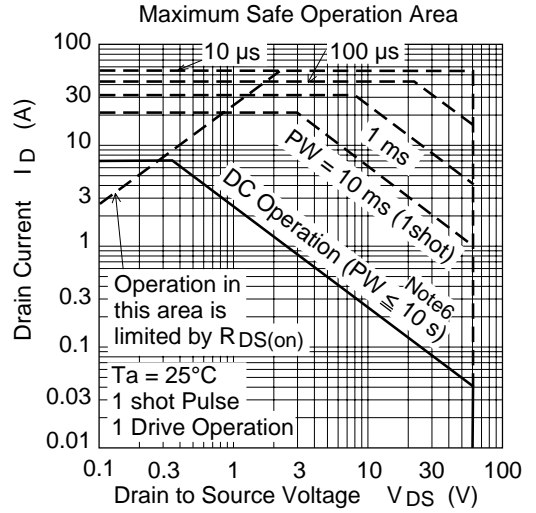
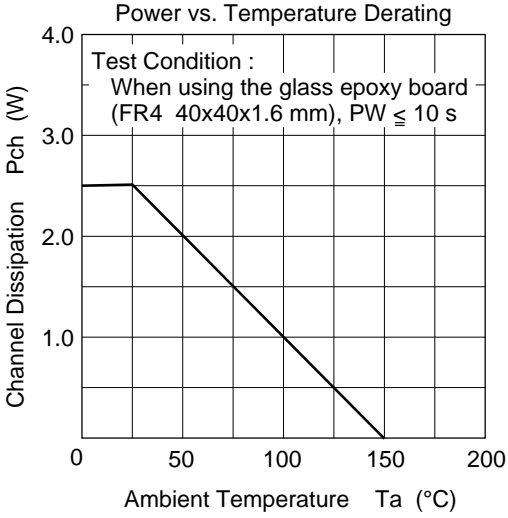

Drain to Source Saturation Voltage vs. Gate to Source Voltage

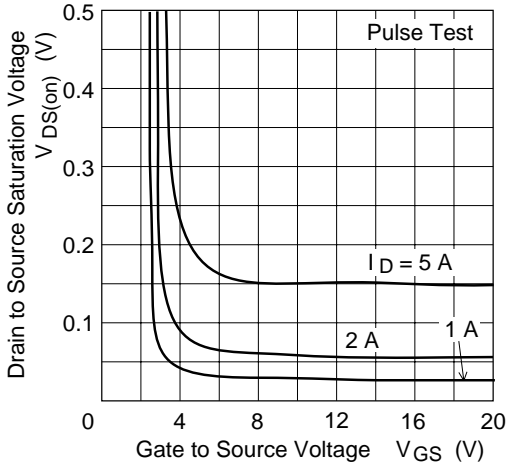

Static Drain to Source on State Resistance vs. Drain Current

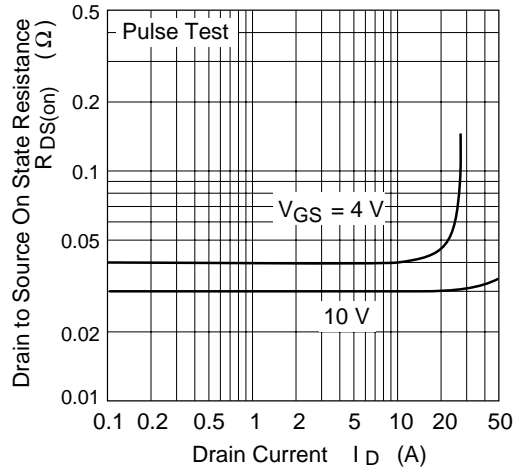

Static Drain to Source on State Resistance vs. Temperature

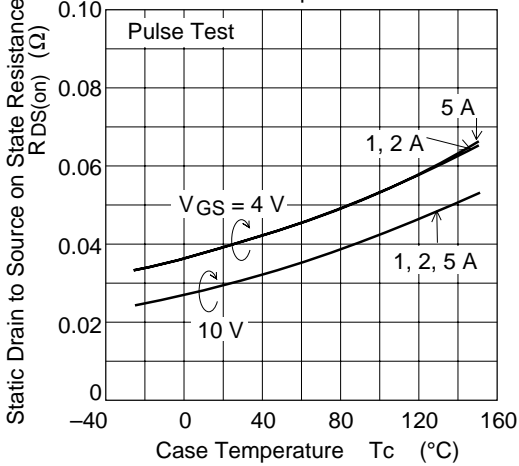

Forward Transfer Admittance vs. Drain Current

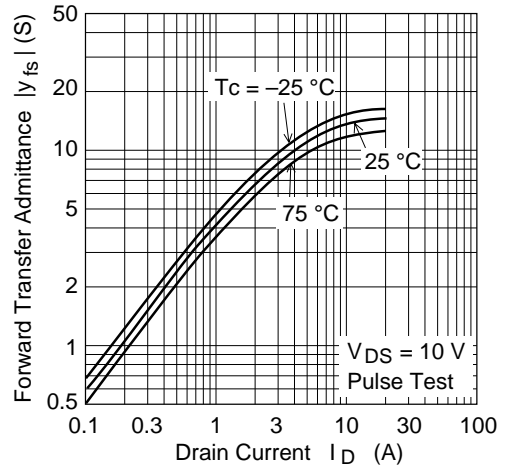

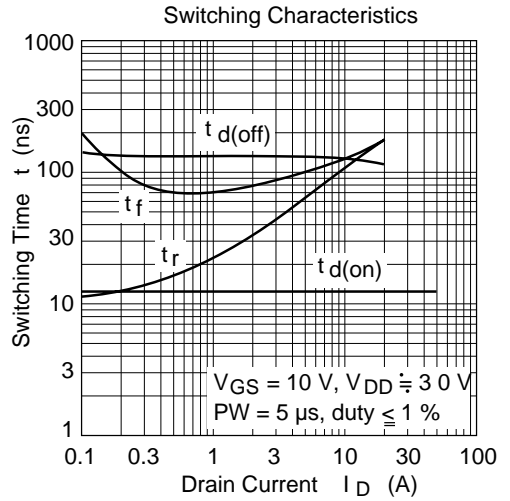
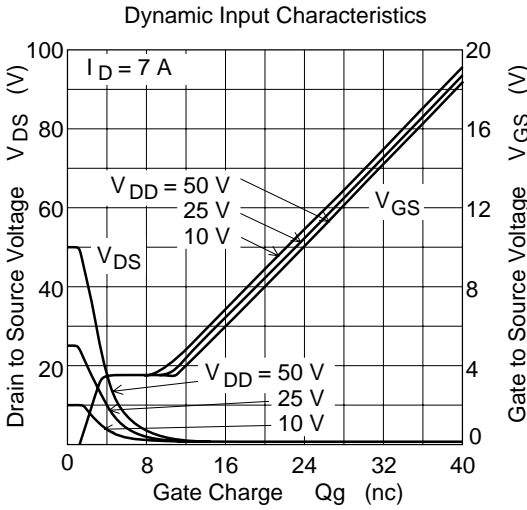
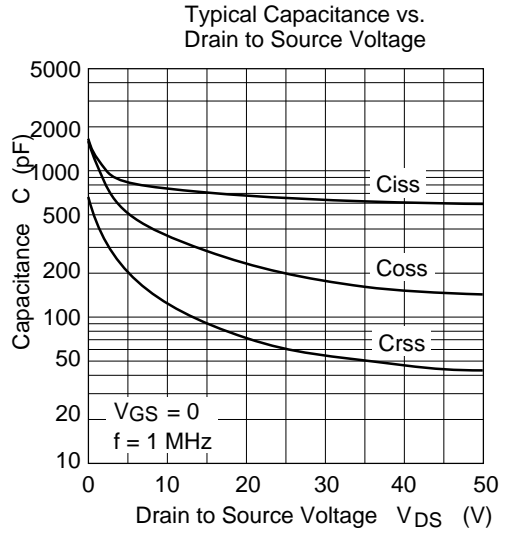
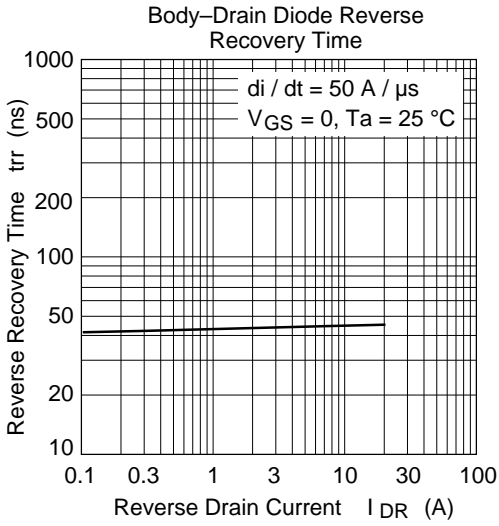

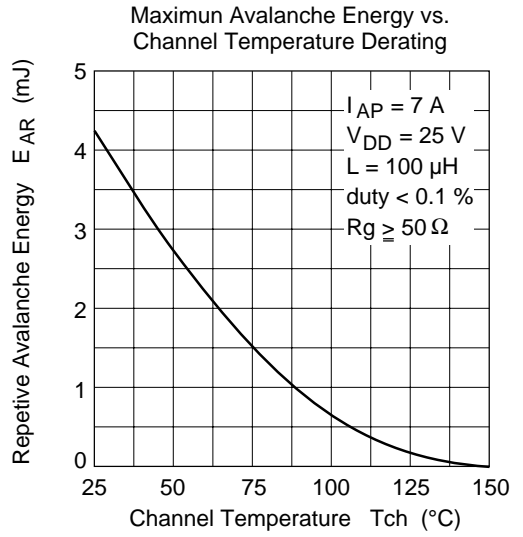
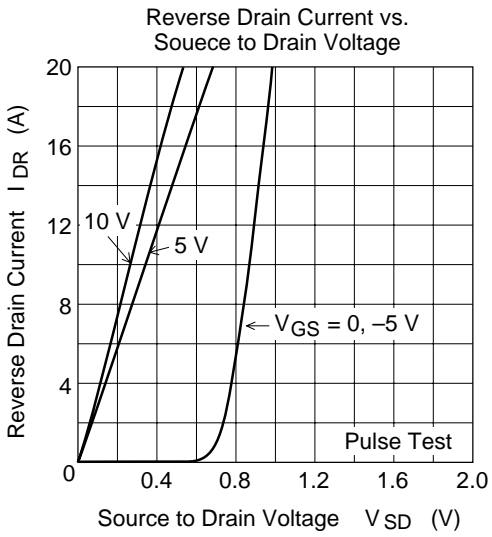

Avalanche Test Circuit

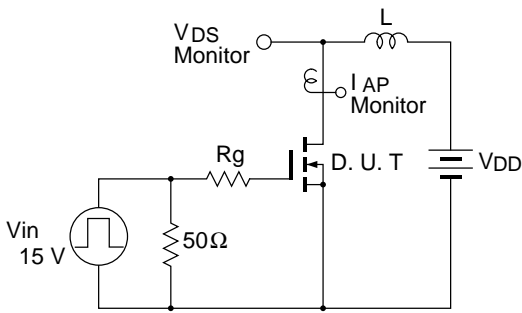

Avalanche Waveform

$$E_{AR} = \frac{1}{2} \cdot L \cdot I_{AP}^2 \cdot \frac{V_{DSS}}{V_{DSS} - V_{DD}}$$

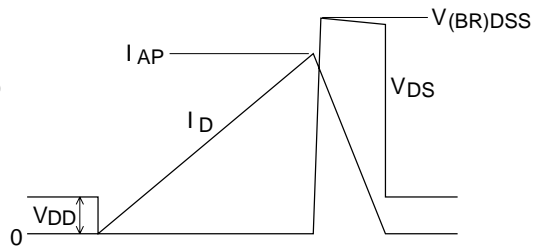

Normalized Transient Thermal Impedance vs. Pulse Width

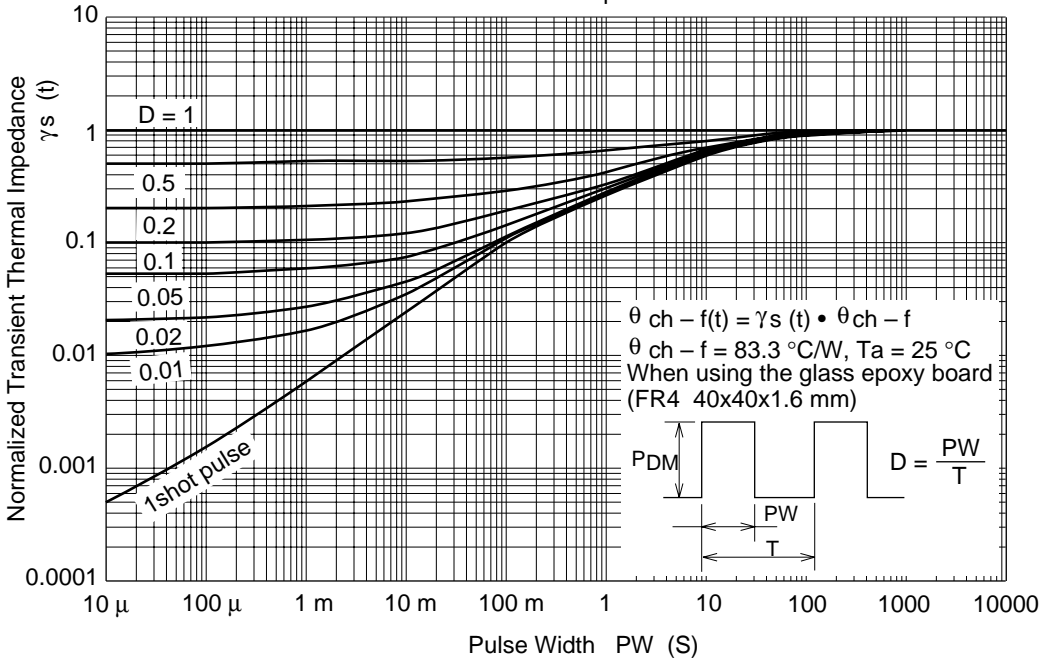

Switching Time Test Circuit

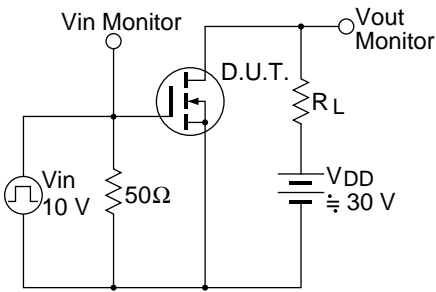

Switching Time Waveform

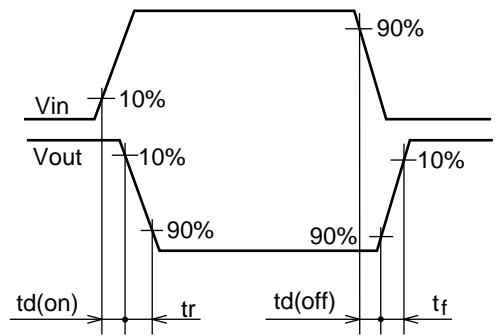

Package Dimensions

Unit: mm

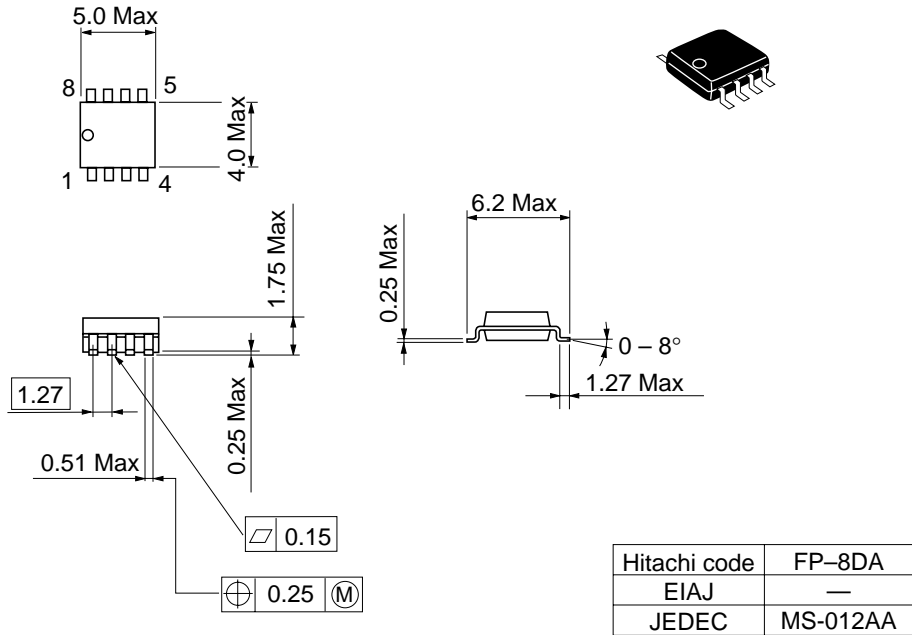

Cautions

1. Hitachi neither warrants nor grants licenses of any rights of Hitachi's or any third party's patent, copyright, trademark, or other intellectual property rights for information contained in this document. Hitachi bears no responsibility for problems that may arise with third party's rights, including intellectual property rights, in connection with use of the information contained in this document.
2. Products and product specifications may be subject to change without notice. Confirm that you have received the latest product standards or specifications before final design, purchase or use.
3. Hitachi makes every attempt to ensure that its products are of high quality and reliability. However, contact Hitachi's sales office before using the product in an application that demands especially high quality and reliability or where its failure or malfunction may directly threaten human life or cause risk of bodily injury, such as aerospace, aeronautics, nuclear power, combustion control, transportation, traffic, safety equipment or medical equipment for life support.
4. Design your application so that the product is used within the ranges guaranteed by Hitachi particularly for maximum rating, operating supply voltage range, heat radiation characteristics, installation conditions and other characteristics. Hitachi bears no responsibility for failure or damage when used beyond the guaranteed ranges. Even within the guaranteed ranges, consider normally foreseeable failure rates or failure modes in semiconductor devices and employ systemic measures such as fail-safes, so that the equipment incorporating Hitachi product does not cause bodily injury, fire or other consequential damage due to operation of the Hitachi product.
5. This product is not designed to be radiation resistant.
6. No one is permitted to reproduce or duplicate, in any form, the whole or part of this document without written approval from Hitachi.
7. Contact Hitachi's sales office for any questions regarding this document or Hitachi semiconductor products.

HITACHI

Hitachi, Ltd.

Semiconductor & Integrated Circuits.
Nippon Bldg., 2-6-2, Ohte-machi, Chiyoda-ku, Tokyo 100-0004, Japan
Tel: Tokyo (03) 3270-2111 Fax: (03) 3270-5109

URL North America : <http://semiconductor.hitachi.com/>
Europe : <http://www.hitachi-eu.com/hel/ecg>
Asia (Singapore) : <http://www.has.hitachi.com.sg/grp3/sicd/index.htm>
Asia (Taiwan) : http://www.hitachi.com.tw/E/Product/SICD_Frame.htm
Asia (HongKong) : <http://www.hitachi.com.hk/eng/bo/grp3/index.htm>
Japan : <http://www.hitachi.co.jp/Sicd/indx.htm>

For further information write to:

Hitachi Semiconductor
(America) Inc.
179 East Tasman Drive,
San Jose, CA 95134
Tel: <1> (408) 433-1990
Fax: <1> (408) 433-0223

Hitachi Europe GmbH
Electronic components Group
Dornacher Straße 3
D-85622 Feldkirchen, Munich
Germany
Tel: <49> (89) 9 9180-0
Fax: <49> (89) 9 29 30 00

Hitachi Europe Ltd.
Electronic Components Group.
Whitebrook Park
Lower Cookham Road
Maidenhead
Berkshire SL6 8YA, United Kingdom
Tel: <44> (1628) 585000
Fax: <44> (1628) 778322

Hitachi Asia Pte. Ltd.
16 Collyer Quay #20-00
Hitachi Tower
Singapore 049318
Tel: 535-2100
Fax: 535-1533

Hitachi Asia Ltd.
Taipei Branch Office
3F, Hung Kuo Building, No.167,
Tun-Hwa North Road, Taipei (105)
Tel: <886> (2) 2718-3666
Fax: <886> (2) 2718-8180

Hitachi Asia (Hong Kong) Ltd.
Group III (Electronic Components)
7/F., North Tower, World Finance Centre,
Harbour City, Canton Road, Tsim Sha Tsui,
Kowloon, Hong Kong
Tel: <852> (2) 735 9218
Fax: <852> (2) 730 0281
Telex: 40815 HITEC HX

Copyright ' Hitachi, Ltd., 1999. All rights reserved. Printed in Japan.

HITACHI