

Thick Film Thermal Printhead (8dots / mm)

KF2008-GK11A

The KF2008-GK11A use a high durability protective film to accept top coated label sheet.
This is a light and small thick film type printhead which achieved 1 inch / s printing speed.

●Applications

POS terminal printers
Label printers
CAT printers
General purpose compact printers

●Features

- 1) A high durability protective film has been developed newly as a counter measure against static electricity.
- 2) The clip connector for the FFC specifications has been developed newly using an original technology thereby making it possible to achieve even smaller size.
- 3) A newly developed 144-bits IC levels the strobe partition and reduces the noise level.
- 4) One rank resistance value of $1500\Omega\pm 3\%$ eliminates the inconvenience of rank selection.

●External dimensions (Units : mm)

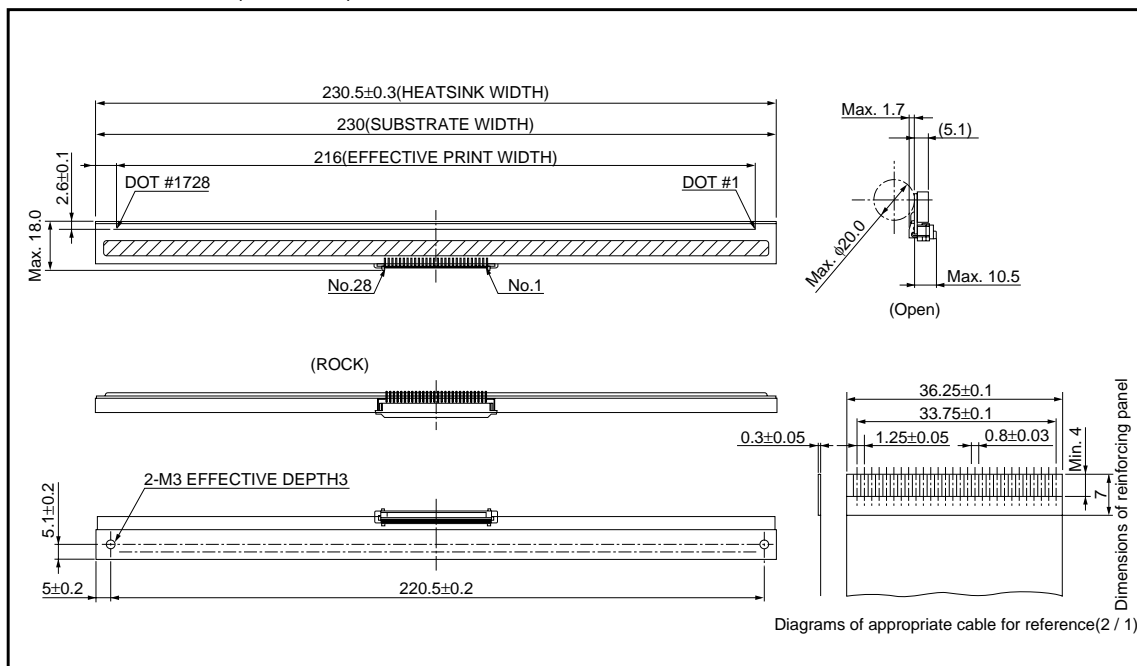

Printheads

●Equivalent circuit

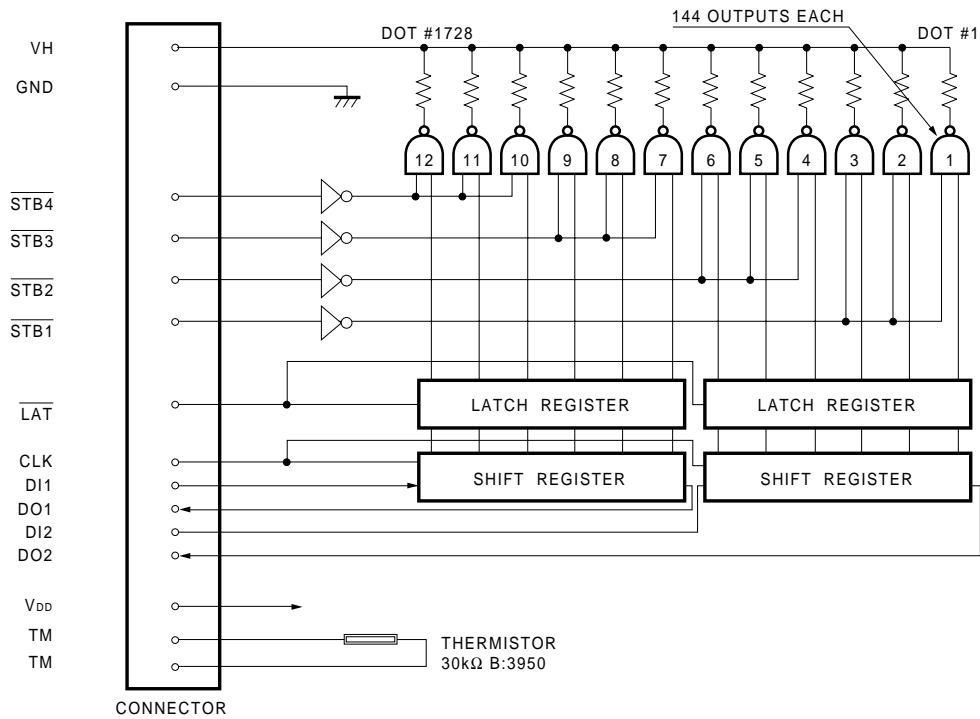

Fig. 1

●Pin configuration

No.	Circuit	No.	Circuit
1	VH	15	GND
2	VH	16	GND
3	VH	17	GND
4	DO2	18	GND
5	DI2	19	TM
6	CLK	20	V _{DD}
7	LAT	21	STB3
8	STB1	22	STB4
9	STB2	23	DO1
10	TM	24	DI1
11	GND	25	VH
12	GND	26	VH
13	GND	27	VH
14	GND	28	VH

Printheads

●Timing chart

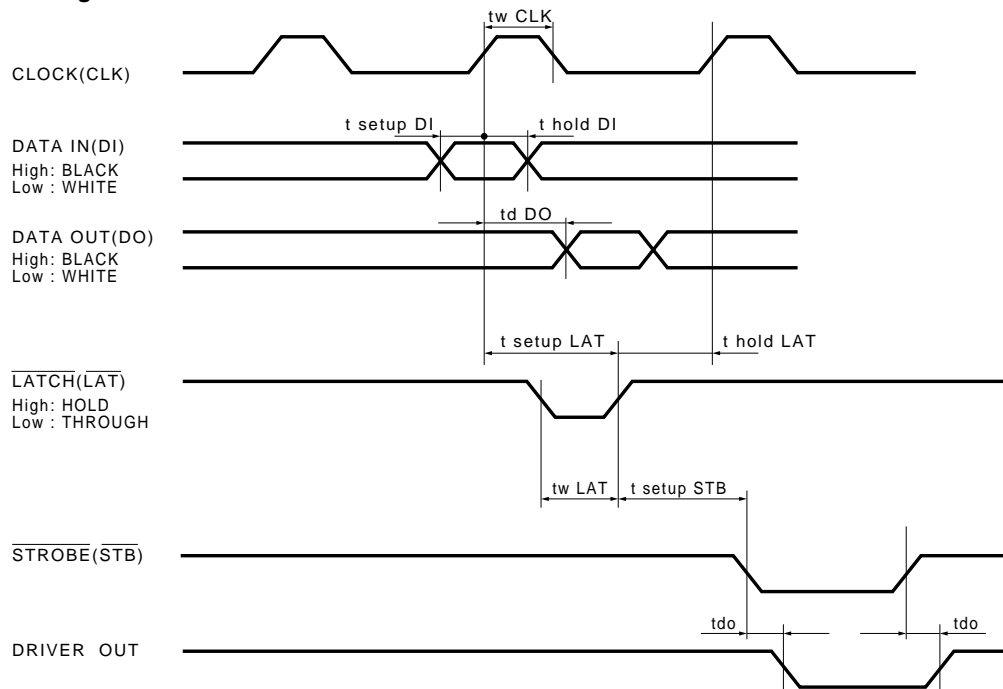

Fig. 2

●Characteristics

Parameter	Symbol	Typical	Unit
Effective printing width	—	216.0	mm
Dot pitch	—	0.125	mm
Total dot number	—	1728	dots
Average resistance value	Rave	1500	Ω
Applied voltage	V _H	24.0	V
Applied power	P _O	0.30	W / dot
Print cycle	SLT	5.0	ms
Pulse width	T _{ON}	0.80	ms
Maximum number of dots energized simultaneously	—	432	dots
Maximum clock frequency	—	4	MHz
Maximum roller diameter	—	14.0	mm
Running life / pulse life	—	50 / 5×10 ⁷	km / pulses
Operating temperature	—	5~45	°C

Printheads

●Data sheet

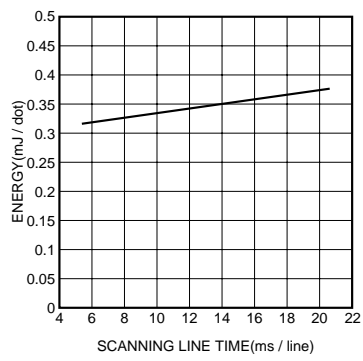

Fig. 3 Adaptive speed chart

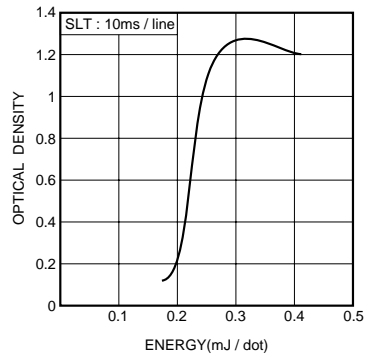

Fig. 4 Representative density curve

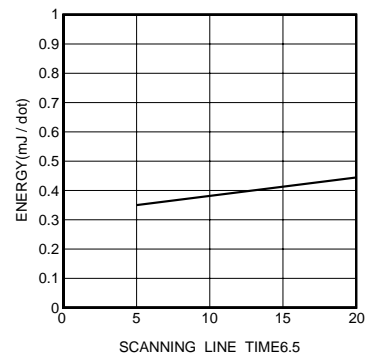

Fig. 5 Maximum energy curve

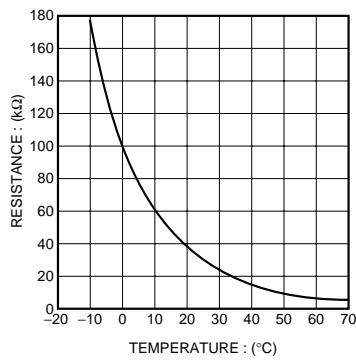

Fig. 6 Thermistor curve