

SANYO**LA1816, 1816M****Single-Chip AM/FM, MPX Tuner System for Headphone Stereos, Radio-Cassette Recorders****Functions**

- FM: RF amplifier, MIX, OSC, IF amplifier, quadrature detector
- AM: RF amplifier, MIX, OSC, IF amplifier, detector, AGC
- MPX: PLL stereo decoder, stereo indicator, VCO stop

Features

- Contains FM tuner, AM tuner, MPX on a single chip.
- Adjustment-free FM detector and AM IF
- Minimum number of external parts required
- Low-voltage operation
- Low current drain
- Less carrier leak of MPX (no-input, monaural-input mode)

Package Dimensions

unit : mm

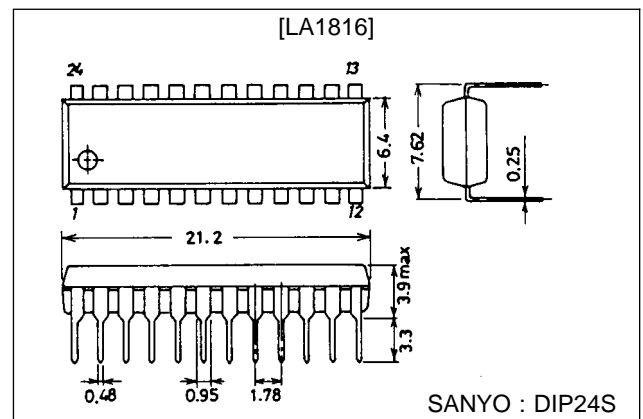
3067-DIP24S

unit : mm

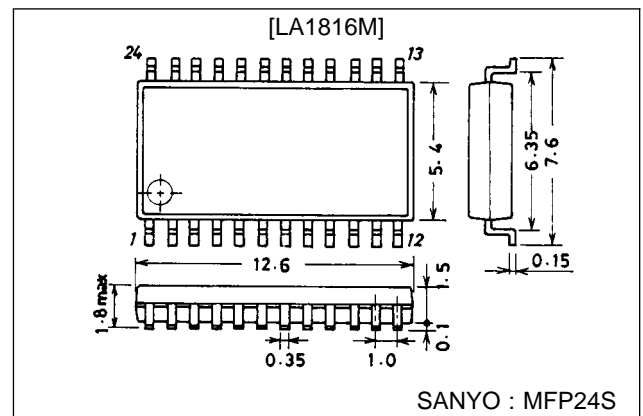
3112-MFP24S**Specifications****Maximum Ratings at Ta = 25°C, See specified Test Circuit**

Parameter	Symbol	Conditions	Ratings	Unit
Maximum supply voltage	$V_{CC \text{ max}}$	Pins 8, 9, 11, 18, 20, 22	7	V
Maximum supply current	$I_{CC \text{ max}}$	Pins 8 + 18 + 20 + 22	50	mA
Flow-in current (Indicator drive current)	I_{LED}	Pin 9	10	mA
Flow-out current	I_{21}	Pin 21	0.1	mA
Allowable power dissipation	$P_d \text{ max}$	$T_a \leq 70^\circ\text{C}$	350	mW
Operating temperature	T_{opr}		-20 to +70	°C
Storage temperature	T_{stg}		-40 to +125	°C

SANYO Electric Co.,Ltd. Semiconductor Business Headquarters

TOKYO OFFICE Tokyo Bldg., 1-10, 1 Chome, Ueno, Taito-ku, TOKYO, 110 JAPAN

N3097HA(II)/8099YT/N307TA/N197TA,TS No.2659-1/11

LA1816, 1816M

Operating Conditions at $T_a = 25^\circ\text{C}$

Parameter	Symbol	Conditions	Ratings	Unit
Recommended supply voltage	V_{CC}		3	V
Operating voltage range	$V_{CC\ op}$		1.8 to 6.0	V

Operating Characteristics at $T_a = 25^\circ\text{C}$, $V_{CC} = 3\text{ V}$, See specified Test Circuit

Parameter	Symbol	Conditions	min	typ	max	Unit
Quiescent current	I_{CCO} (FM)	FM mode $V_{IN} = 0$		8.9	15	mA
	I_{CCO} (AM)	AM mode $V_{IN} = 0$		3.3	5.5	mA
[AM Characteristics] : $f_c = 1000\text{ kHz}$, $f_m = 1\text{ kHz}$						
Detection output	V_{O1}	$V_{IN} = 23\text{ dB}\mu$, 30% mod.	12	23	41	mV
	V_{O2}	$V_{IN} = 80\text{ dB}\mu$, 30% mod.	48	74	120	mV
Signal to noise ratio	S/N1	$V_{IN} = 23\text{ dB}\mu$, 30% mod.	16	21		dB
	S/N2	$V_{IN} = 80\text{ dB}\mu$, 30% mod.	45	52		dB
Total harmonic distortion	THD1	$V_{IN} = 80\text{ dB}\mu$, 30% mod.		0.3	1.3	%
	THD2	$V_{IN} = 107\text{ dB}\mu$, 30% mod.		0.6	2.0	%
[FM Characteristics] (F.E.) : $f_c = 98\text{ MHz}$, $f_m = 1\text{ kHz}$						
-3 dB sensitivity	-3dBLS.	Referenced to $V_{IN} = 80\text{ dB}\mu$, 30% mod., 3 dB down		12		dB μ
Local oscillation voltage	V_{OSC}	$f_{OSC} = 108.7\text{ MHz}$	75	110	160	mV
[FM Characteristics] (IF + MPX, MONO) : $f_c = 10.7\text{ MHz}$, $f_m = 1\text{ kHz}$						
-3 dB sensitivity	-3dBLS.	Referenced to $V_{IN} = 100\text{ dB}\mu$, 100% mod., 3 dB down		39	46	dB μ
Demodulation output	V_O	$V_{IN} = 100\text{ dB}\mu$, 100% mod.	100	135	200	mV
Channel balance	C.B.	$V_{IN} = 100\text{ dB}\mu$, 100% mod.		0	2.0	dB
Total harmonic distortion	THD (mono)	$V_{IN} = 100\text{ dB}\mu$, 100% mod.		0.7	3.0	%
Signal to noise ratio	S/N	$V_{IN} = 100\text{ dB}\mu$, 100% mod.	70	75		dB
[FM Characteristics] (IF + MPX, STEREO) : $f_c = 10.7\text{ MHz}$, $f_m = 1\text{ kHz}$, L + R = 90%, pilot = 10%, $V_{IN} = 100\text{ dB}\mu$						
Channel separation*	Sep		25	34		dB
Total harmonic distortion	THD (main)			0.6	2.5	%
LED-ON level	V_{LED-ON}		2.0	3.5	5.0	%
LED-OFF level	$V_{LED-OFF}$			2.7		%

* Sep = 45 dB (typ) at MPX IN

LA1816, 1816M

Equivalent Circuit Block Diagram

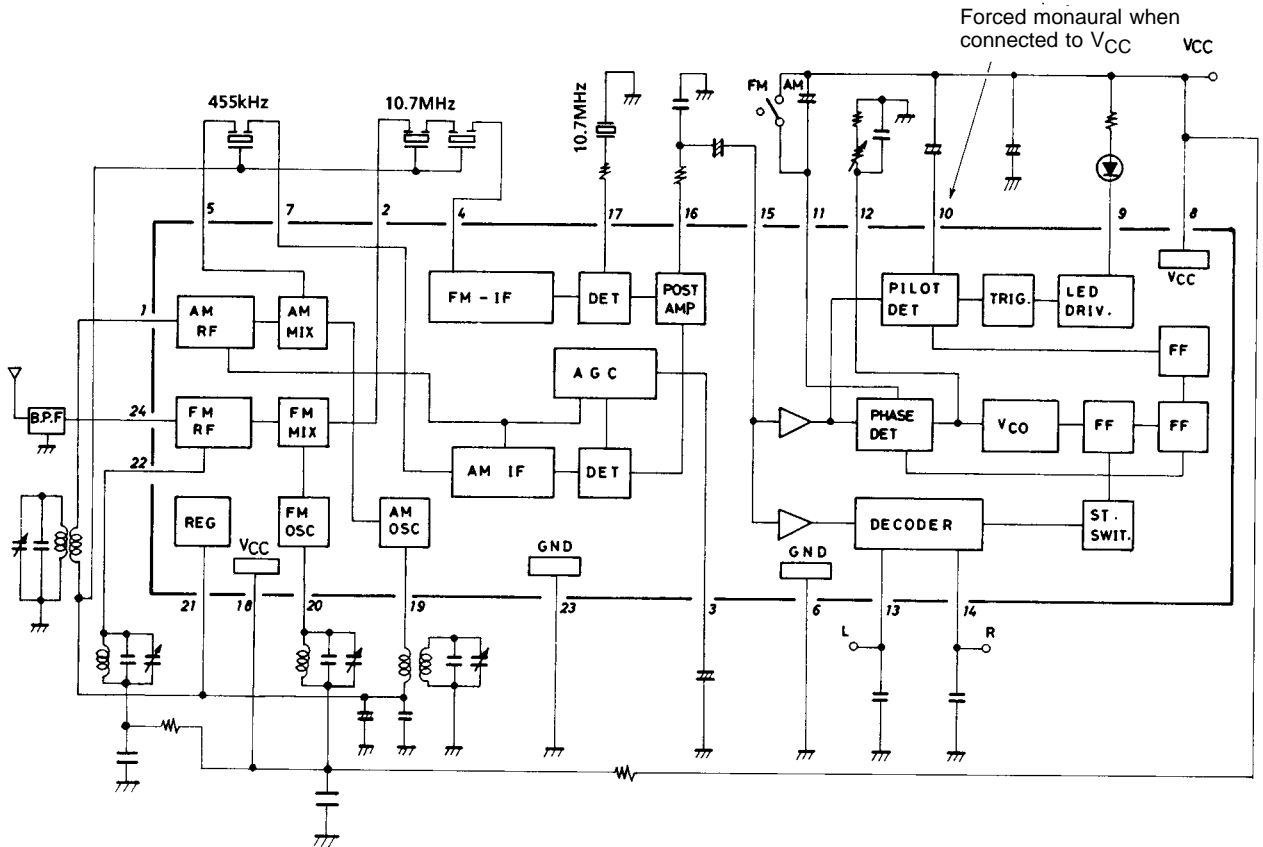

Test Circuit

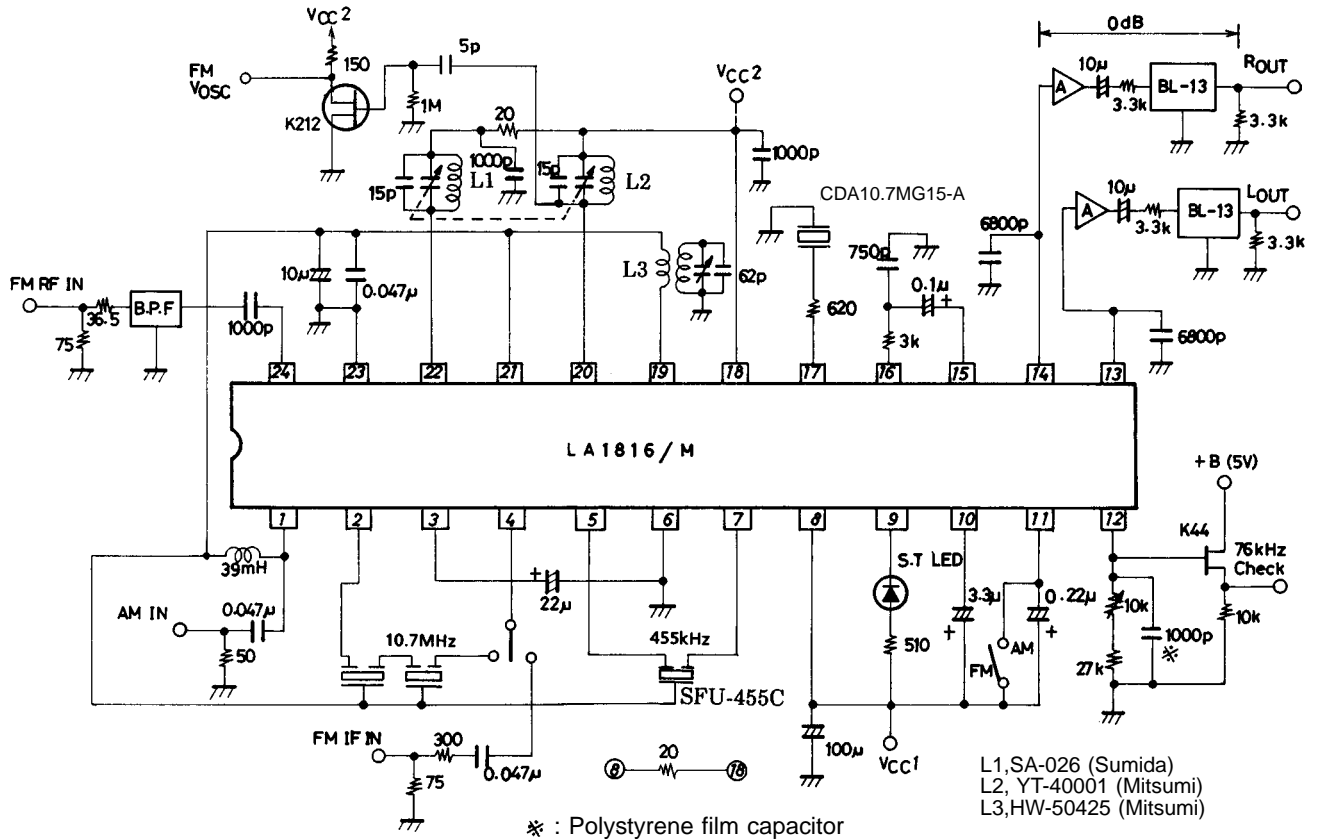

Unit (resistance: Ω , capacitance: F)

LA1816, 1816M

Coil Specifications

FM

- ANT B.P.F
SNY-074-2001 (Sumida)
- OSC
YT-40001 (Mitsumi)
5.5 mm ϕ air core, 0.8 mm wire, 3T
- RF SA-026(Sumida)
3.5 mm ϕ air core, 1.0 mm wire, 5T
- Discriminator
CDA 10.7MG (15) (Murata)

AM

- MW OSC
HW-50425
(Mitsumi)

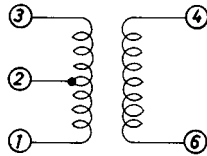

- ③ - ② 2T
- ④ - ⑥ 9T $Q_o \geq 80$
- ② - ① 86T $L = 270 \mu H$

- Bar antenna
TYA-8032 (PVC-2LXT-L)
(Mitsumi)

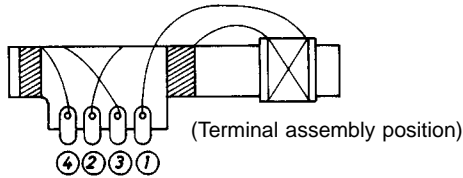

- ① - ② 21T • 100T
- ③ - ④ 30T
- ① - ② $L = 604 \mu H$
 $Q_o \geq 120$

Sample Printed Circuit Pattern

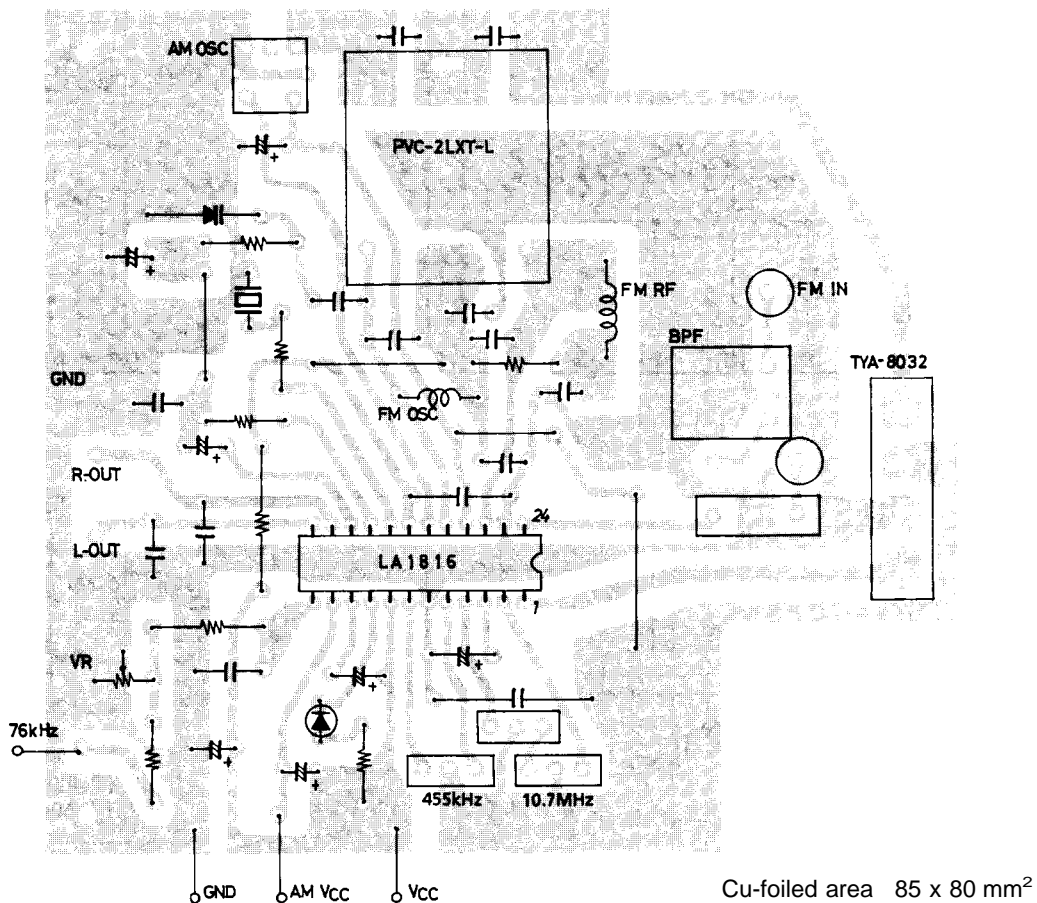

LA1816, 1816M

How to use the LA1816

1. VCO stop
The VCO is stopped by shorting pin 10 and pin 8 (V_{CC} pin).
Note) The maximum supply voltage on pin 10 must not exceed the voltage on pin 8.
2. Free-running frequency check
Either of the following two methods is used to check the free-running frequency.
 - (a) Connect pin 12 to a frequency counter through the high input impedance amplifier.

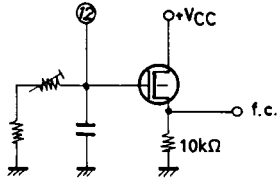

Figure 1

- (b) Connect the connection point of the semifixed resistor connected to pin 12 and the fixed resistor to a frequency counter through the resistor of 240 kΩ or greater.
How the error changes with the resistor value is shown in Figure 2.

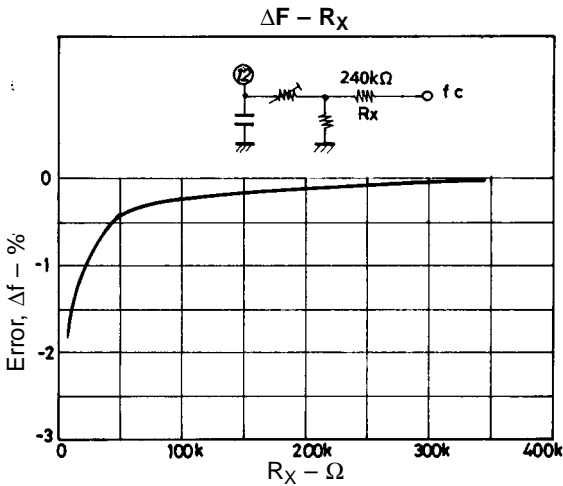

Figure 2

3. How to use the FM DET coil
For pin 17 (FM DET), a coil may be used instead of adjustment-free FM discriminator.

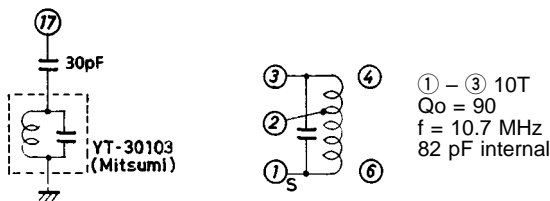

Figure 3 How to use the FM DET coil

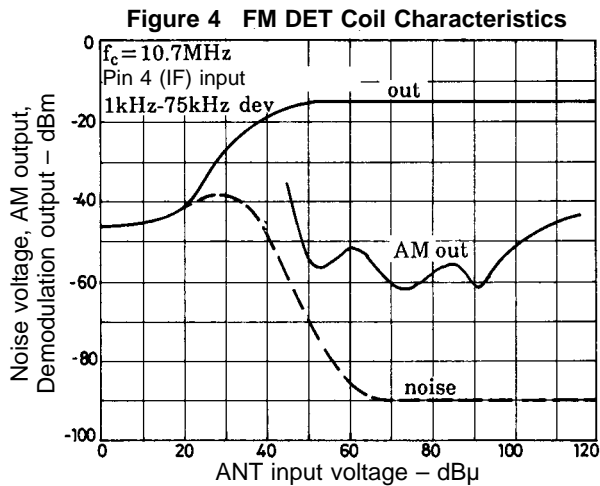

Figure 4 FM DET Coil Characteristics

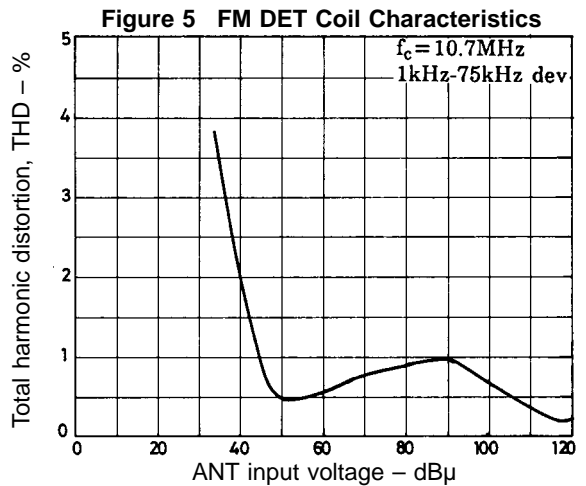

Figure 5 FM DET Coil Characteristics

LA1816, 1816M

4. How to use the FM AFC

The S curve at output pin 16 is as shown Figure 6. Figure 7 shows how to provide FM AFC.

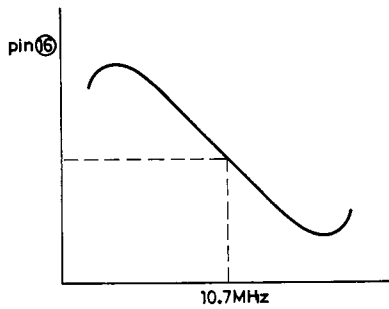

Figure 6

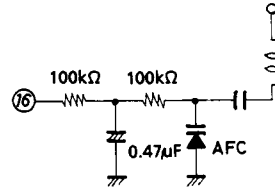

Figure 7

5. AM-FM selection

The FM mode is entered with pin 11 open as shown in Figure 8. When pin 11 and pin 8 are made to be at the same potential in terms of DC, the AM mode is entered. It should be noted that the dynamic range is narrowed whether the potential at pin 11 is lower or higher than that at pin 8.

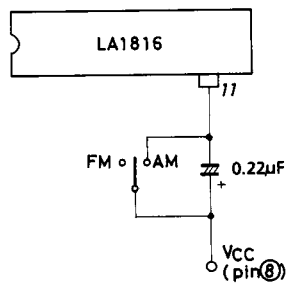
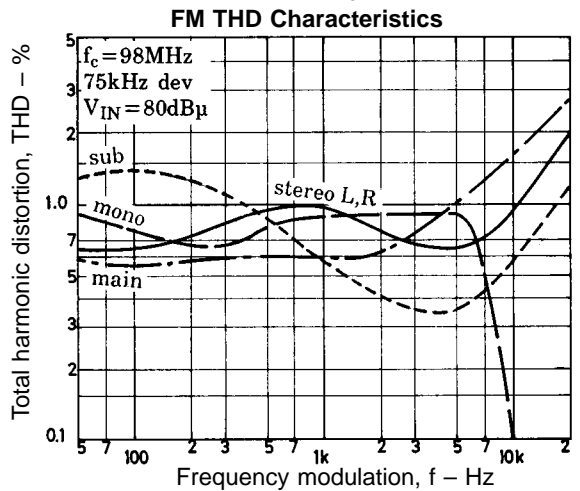
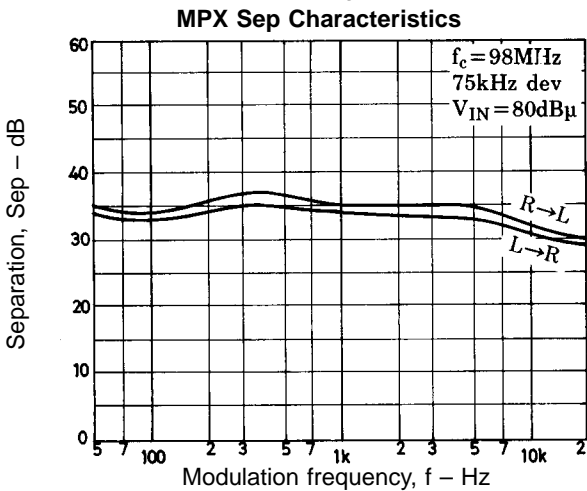
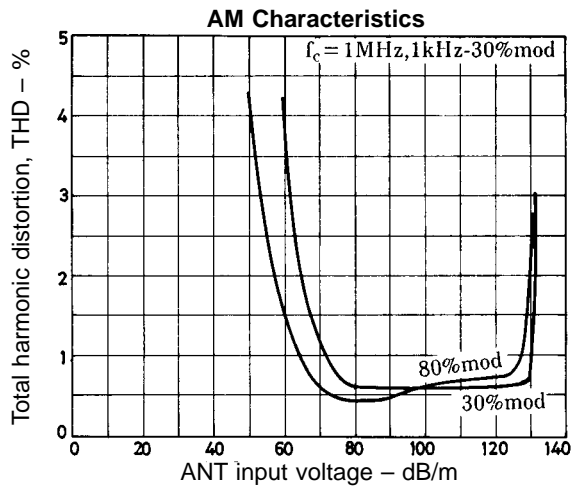
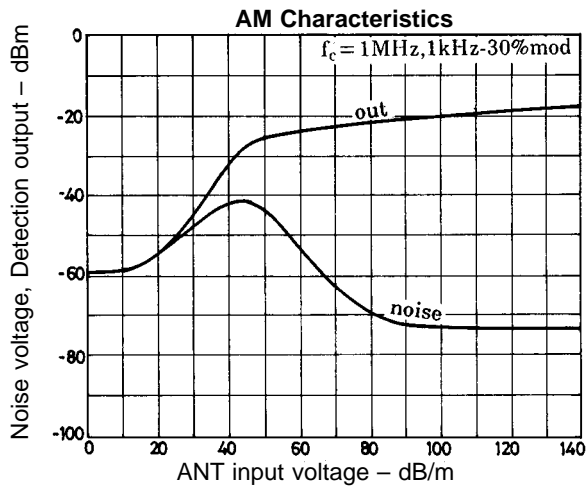
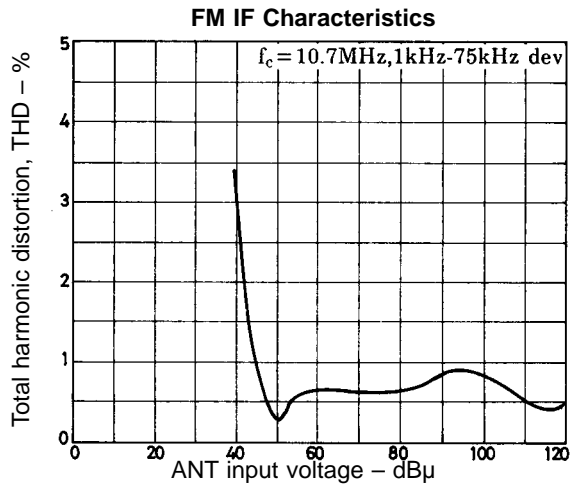
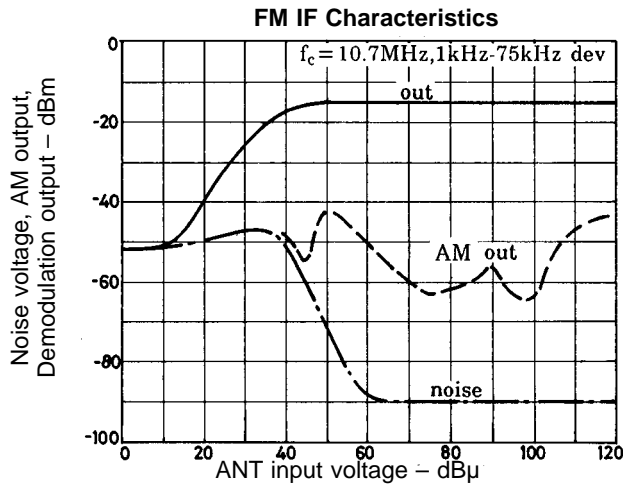
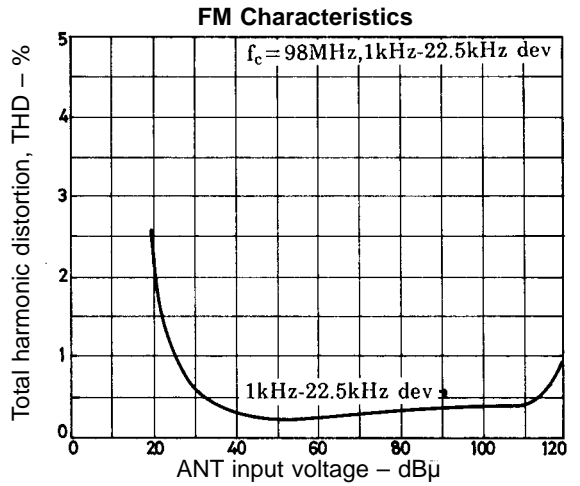
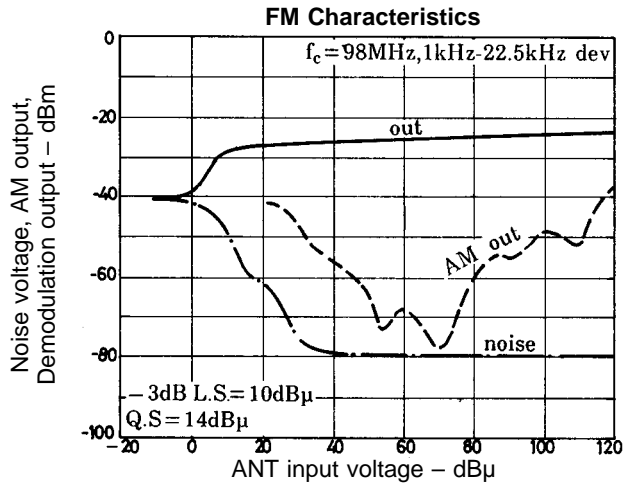
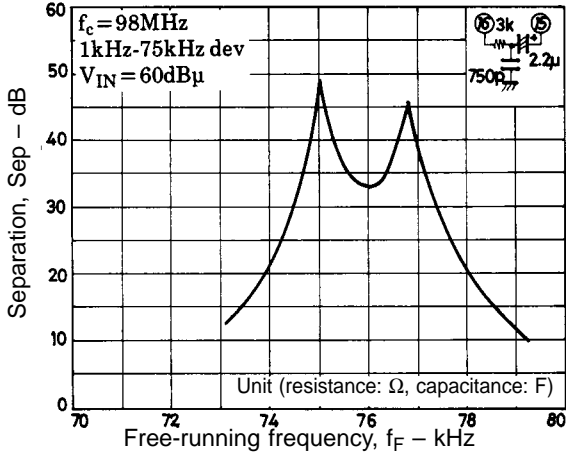

Figure 8

LA1816, 1816M



MPX Sep Characteristics



MPX Capture Range Characteristics

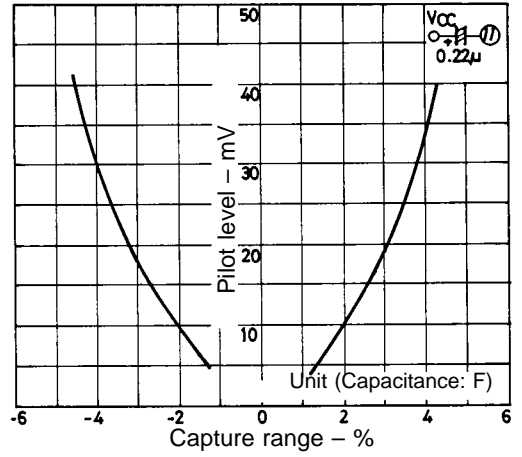

MPX THD - V_IN Characteristics

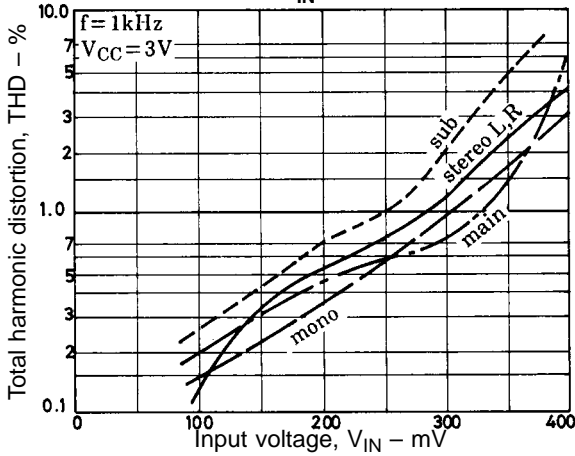

AM Selectivity Characteristics

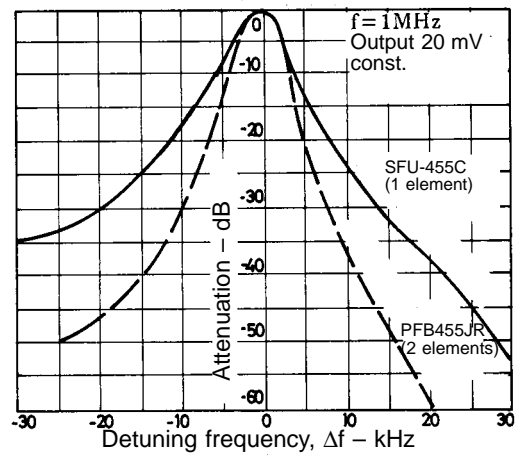

AM Fidelity Characteristics

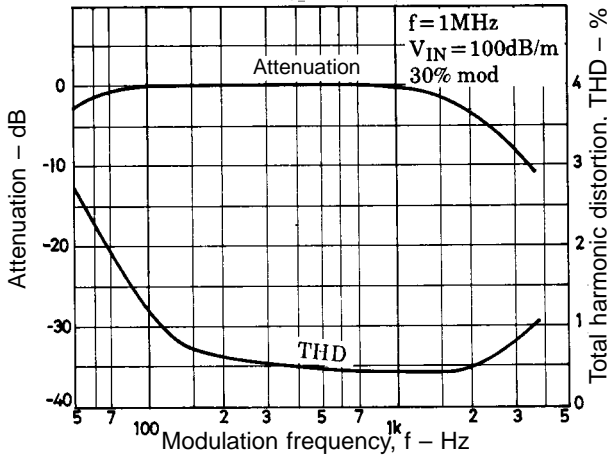

AM Whistle Characteristics

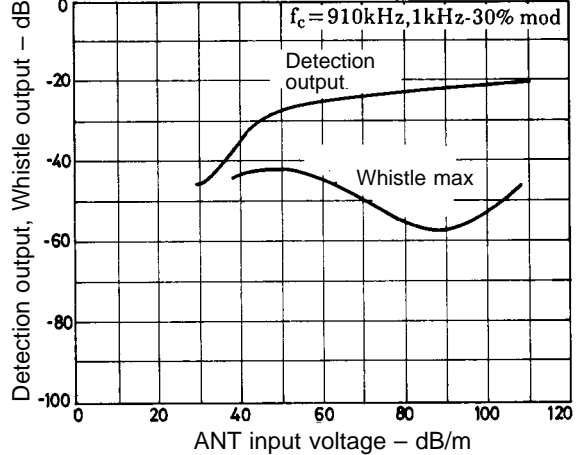

MW Receiving Characteristics

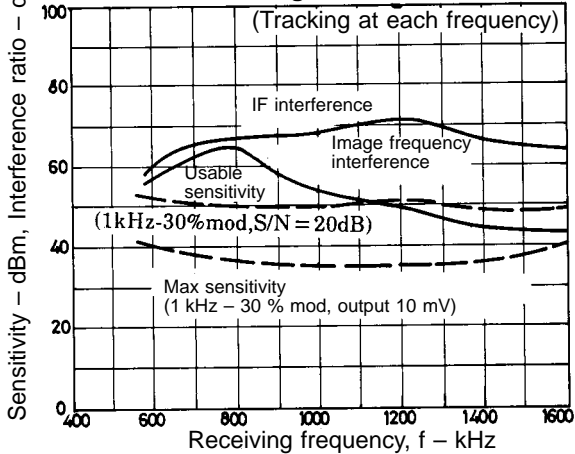

AM Spurious Characteristics

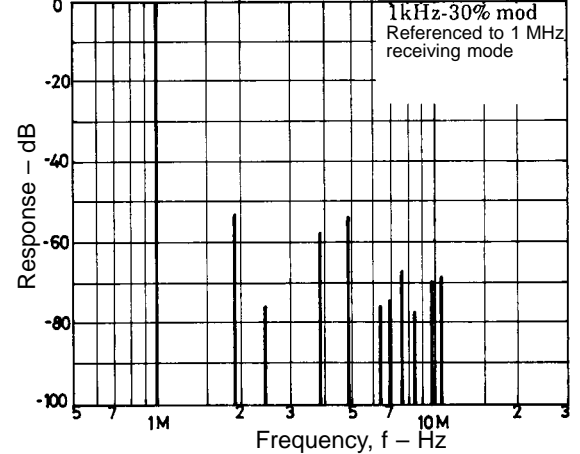

LA1816, 1816M

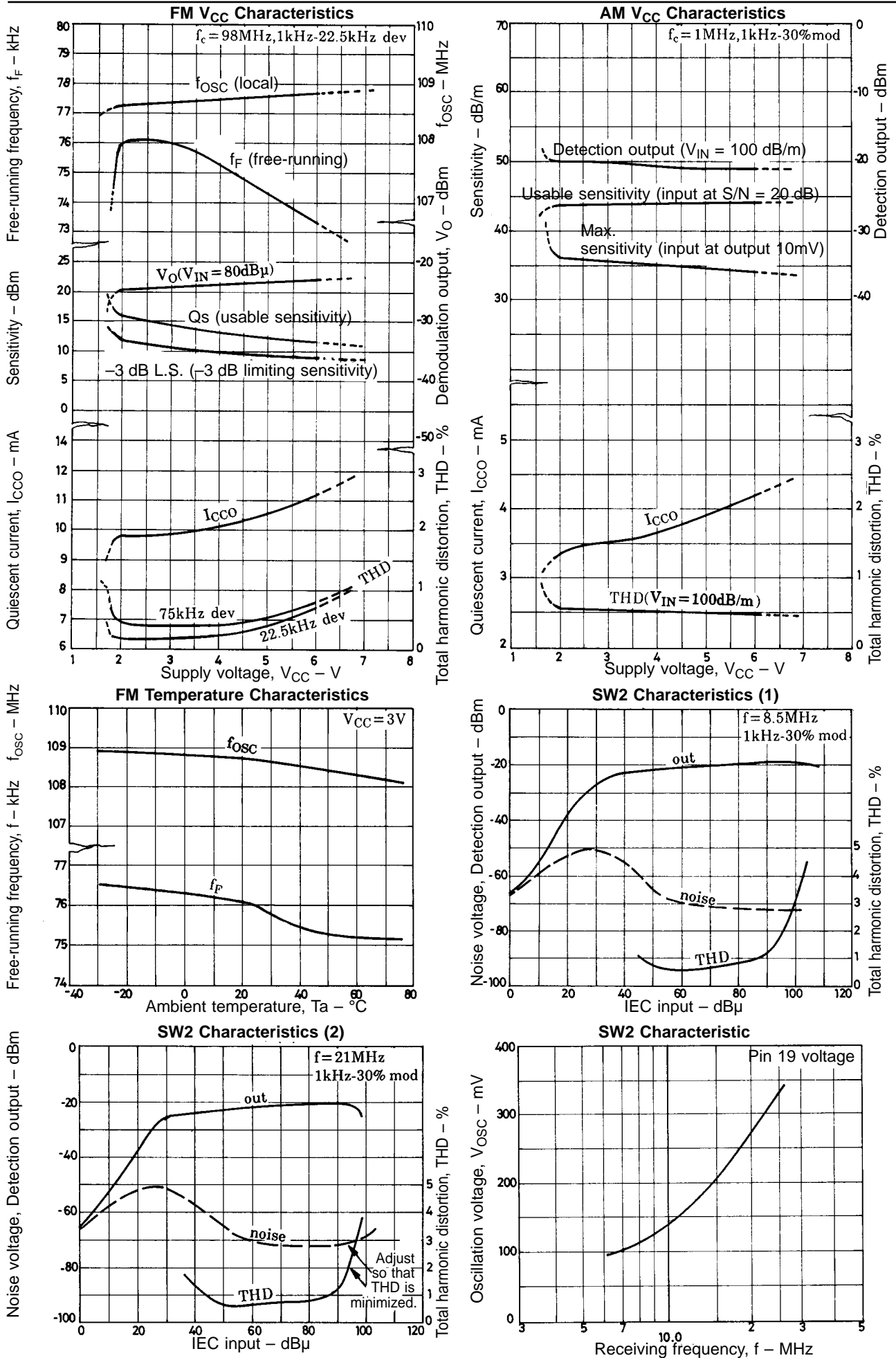

LA1816, 1816M

SW Band Test Circuit

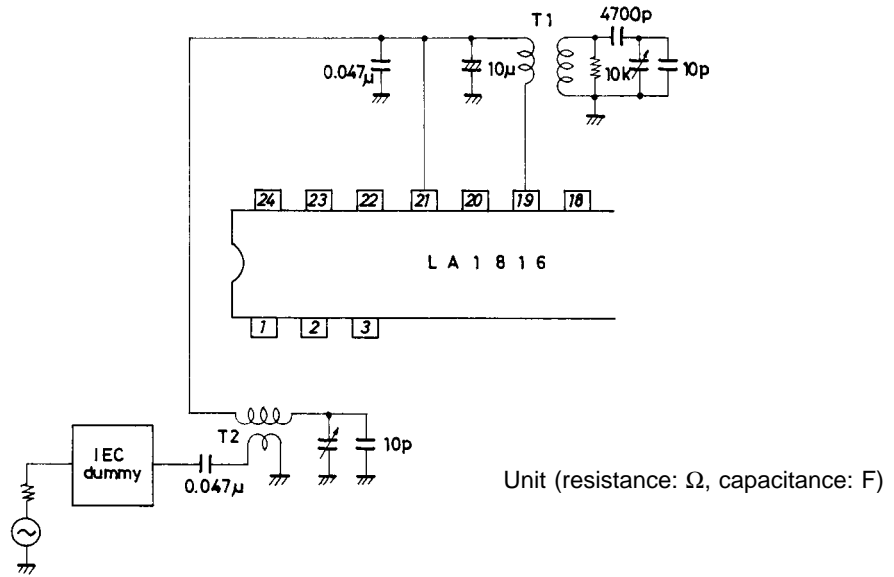

Coil Specifications

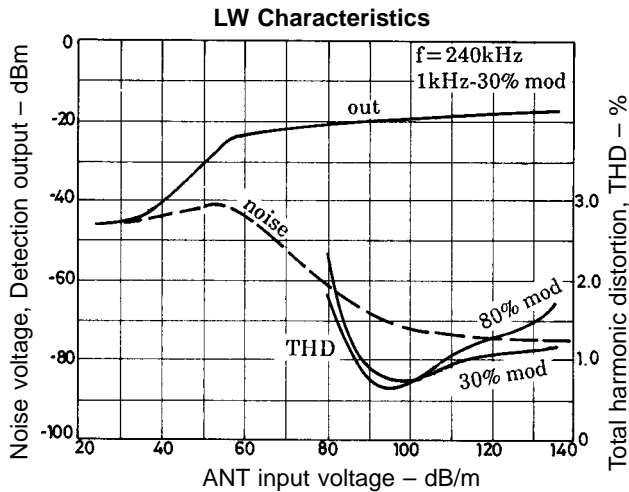
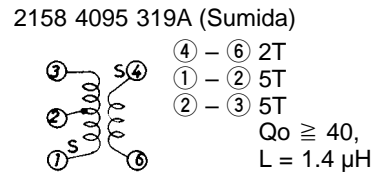
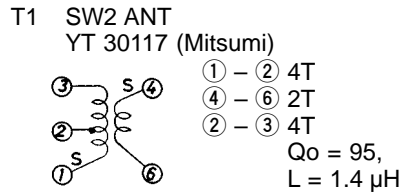
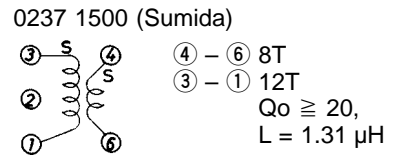
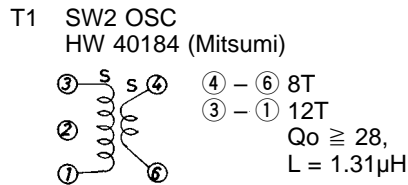

LW Band Test Circuit

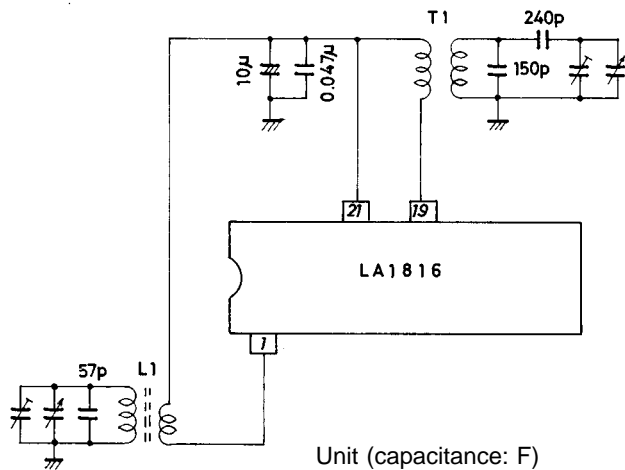

Coil Specifications

T1 • LW OSC
MA-7014 (Mitsumi)

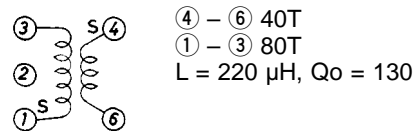

L1 • LW bar antenna
HH-50161 (Mitsumi)

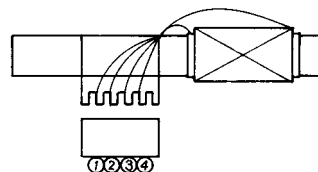

① - ② 20T
③ - ④ 200T
③ - ④ L = 2.74 mH, Qo ≥ 200

- No products described or contained herein are intended for use in surgical implants, life-support systems, aerospace equipment, nuclear power control systems, vehicles, disaster/crime-prevention equipment and the like, the failure of which may directly or indirectly cause injury, death or property loss.
- Anyone purchasing any products described or contained herein for an above-mentioned use shall:
 - ① Accept full responsibility and indemnify and defend SANYO ELECTRIC CO., LTD., its affiliates, subsidiaries and distributors and all their officers and employees, jointly and severally, against any and all claims and litigation and all damages, cost and expenses associated with such use:
 - ② Not impose any responsibility for any fault or negligence which may be cited in any such claim or litigation on SANYO ELECTRIC CO., LTD., its affiliates, subsidiaries and distributors or any of their officers and employees jointly or severally.
- Information (including circuit diagrams and circuit parameters) herein is for example only; it is not guaranteed for volume production. SANYO believes information herein is accurate and reliable, but no guarantees are made or implied regarding its use or any infringements of intellectual property rights or other rights of third parties.