

**LA4445****5.5W 2-Channel AF Power Amplifier****Features**

- Dual channels.
Output : 5.5W×2 (typ.)
- Minimum number of external parts required.
- Small pop noise at the time of power supply ON/OFF and good starting balance.
- Good ripple rejection : 46dB (typ.)
- Good channel separation.
- Small residual noise (Rg=0).
- Built-in protectors.
 - a. Thermal protector
 - b. Overvoltage, surge protector
 - c. Adjacent pins (9-10, 9-8) short protector

Package Dimensions

unit:mm

3049A-SIP12H

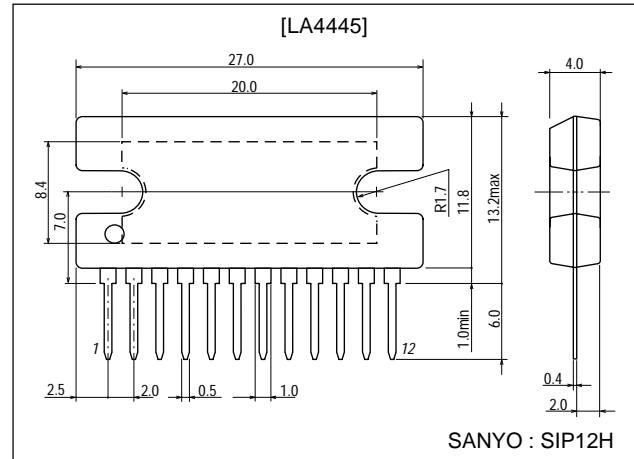
**Specifications****Absolute Maximum Ratings** at Ta = 25°C

Parameter	Symbol	Conditions	Ratings	Unit
Maximum supply voltage	V _{CC} max1	Quiescent (t=30s)	25	V
	V _{CC} max2	Operating	18	V
Surge supply voltage	V _{CC} (surge)	t≤0.2s	50	V
Maximum output current	I _O peak	1 channel	3.5	A
Allowable power dissipation	Pd max	See Pd max – Ta characteristic.	15	W
Operating temperature	Topr		-20 to +75	°C
Storage temperature	Tstg		-40 to +150	°C

Operating Conditions at Ta = 25°C

Parameter	Symbol	Conditions	Ratings	Unit
Recommended supply voltage	V _{CC}		13.2	V
Recommended load resistance	R _L	2 channels	4	Ω
Operating voltage range	V _{CC} op		10 to 16	V

■ Any and all SANYO products described or contained herein do not have specifications that can handle applications that require extremely high levels of reliability, such as life-support systems, aircraft's control systems, or other applications whose failure can be reasonably expected to result in serious physical and/or material damage. Consult with your SANYO representative nearest you before using any SANYO products described or contained herein in such applications.

■ SANYO assumes no responsibility for equipment failures that result from using products at values that exceed, even momentarily, rated values (such as maximum ratings, operating condition ranges, or other parameters) listed in products specifications of any and all SANYO products described or contained herein.

SANYO Electric Co.,Ltd. Semiconductor Company

TOKYO OFFICE Tokyo Bldg., 1-10, 1 Chome, Ueno, Taito-ku, TOKYO, 110-8534 JAPAN

LA4445

Operating Characteristics at $T_a = 25^\circ\text{C}$, $V_{CC} = 13.2\text{V}$, $R_L = 4\Omega$, $f = 1\text{kHz}$, $R_g = 600\Omega$, with $100 \times 100 \times 1.5\text{mm}^3$ Al heat sink, See specified Test Circuit.

Parameter	Symbol	Conditions	Ratings			Unit
			min	typ	max	
Quiescent current	I_{CCO}			75	150	mA
Voltage gain	V_G		49.5	51.5	53.5	dB
Output power	P_O	THD=10%, 2 channels	5.0	5.5		W
Total harmonic distortion	THD	$P_O = 1\text{W}$		0.15	1.0	%
Input resistance	r_i			30		k Ω
Output noise voltage	V_{NO}	$R_g = 0$		0.6	1.0	mV
		$R_g = 10\text{k}\Omega$		1.0	2.0	mV
Ripple rejection	R_r	$R_g = 0$, $V_R = 200\text{mV}$, $f_R = 100\text{Hz}$		46		dB
Channel separation	Ch sep	$R_g = 10\text{k}\Omega$, $V_O = 0\text{dBm}$	45	55		dB

Equivalent Circuit Block Diagram

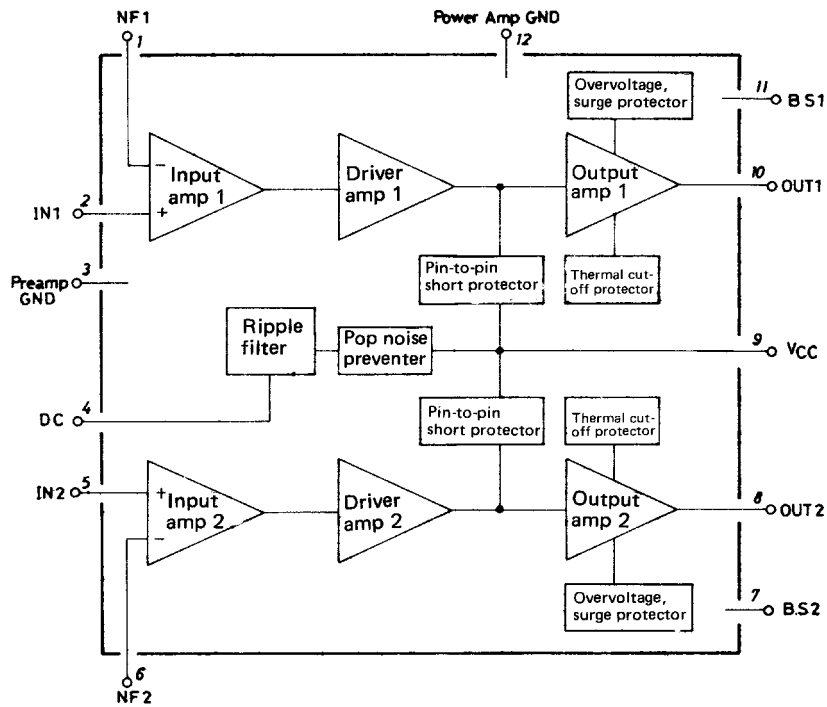

Sample Application Circuit

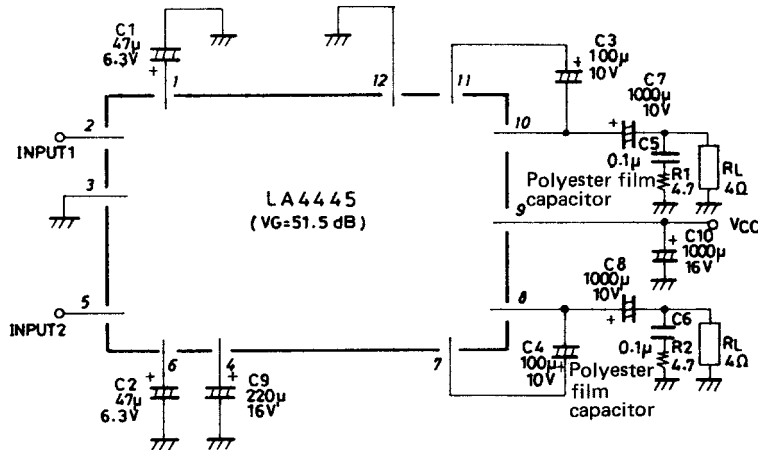

Sample Printed Circuit Pattern

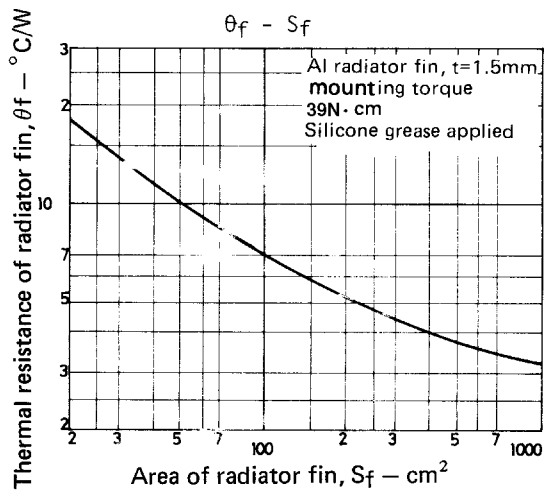
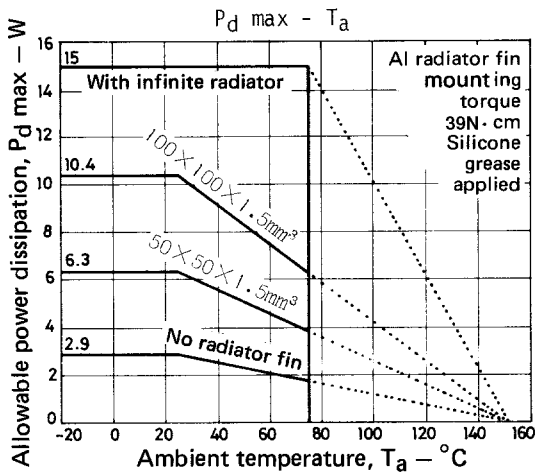
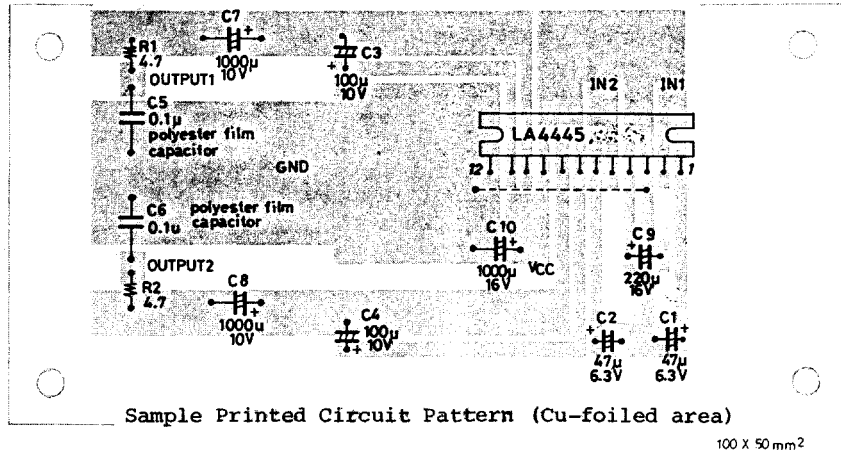

Proper Cares in Mousing Radiator Fin

1. The mounting torque is in the range of 39 to 59N·cm.
2. The distance between screw holes of the radiator fin must coincide with the distance between screw holes of the IC. With case outline dimensions L and R referred to, the screws must be tightened with the distance between them as close to each other as possible.

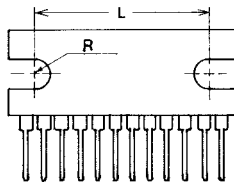

3. The screw to be used must have a head equivalent to the one of truss machine screw or binder machine screw defined by JIS. Washers must be also used to protect the IC case.
4. No foreign matter such as cutting particles shall exist between heat sink and radiator fin. When applying grease on the junction surface, it must be applied uniformly on the whole surface.
5. IC lead pins are soldered to the printed circuit board after the radiator fin is mounted on the IC.

Description of External Parts

- C1 (C2) : Feedback capacitor
Low cutoff frequency f_L depends on this feedback capacitor. Increasing the capacitor value makes the starting time later
- C3 (C4) : Bootstrap capacitor
If the capacitor value is decreased, the output at low frequencies goes lower.
(Recommended value : $47\mu\text{F}$ min.)
- C5 (C6) : Oscillation blocking capacitor
Polyester film capacitor, being excellent in temperature characteristic, frequency characteristic, is recommended. The capacitor value can be reduced to $0.047\mu\text{F}$ depending on the stability of the board.
- C7 (C8) : Output capacitor
The low cutoff frequency depends on this output capacitor. In bridge connection applications the output capacitor must be normally connected.
- C9 : Decoupling capacitor
Used for the ripple filter. Since the rejection effect is saturated at a certain capacitor value, it is meaningless to increase the capacitor value more than needed. This capacitor, being also used for the time constant of the pop noise preventer, affects the starting time. Too small a capacitor value makes the pop noise level higher.
- C10 : Power source capacitor.
- R1 (R2) : Oscillation blocking filter resistor.

IC Application

1. V.G. can be reduced by connecting R_{NF}' to the N.F. pin (pins 1, 6)
V.G. is calculated by the following formula.
$$VG = 20 \log R_f / (R_{NF} + R_{NF}')$$
where $R_f = 20\text{k}\Omega$, $R_{NF} = 50\Omega$
The usable lower limit of VG is 36dB or thereabouts. When setting VG, oscillation and high cutoff frequency f_H must be considered.
2. External audio muting method

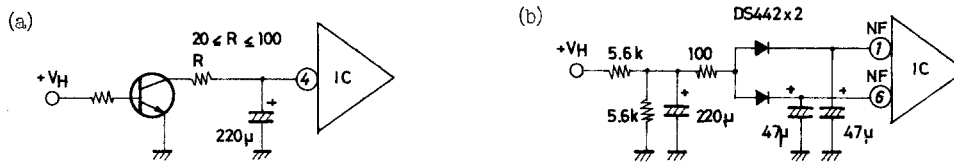

Proper Cares in Using IC

- If the IC is used in the vicinity of the maximum rating, even a slight variation in conditions may cause the maximum rating to be exceeded, thereby leading to breakdown. Allow an ample margin of variation for supply voltage, etc. and use the IC in the range where the maximum ratings is not exceeded.
- Printed circuit board
When making the board, refer to the sample printed circuit pattern. No feedback loop must be formed between input and output. Both Pins GND and Power GND must be shorted at the root of IC pin so that the common impedance can be reduced.
- Others
The radiator fin on the package must be normally connected to GND.
Some plug jacks to be used for connecting to the external speaker are such that both poles are shorted once when connecting. In this case, the load is shorted, which may break down the IC.

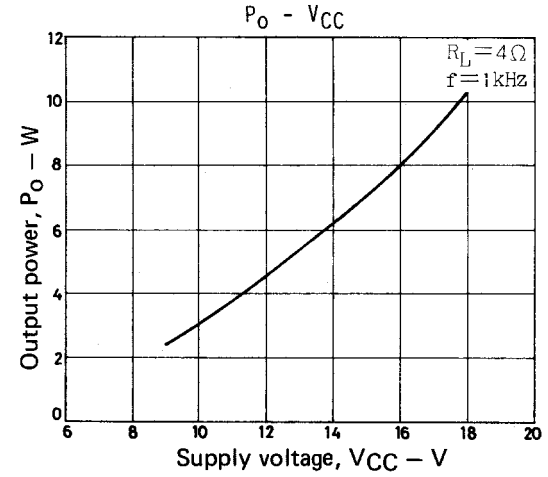
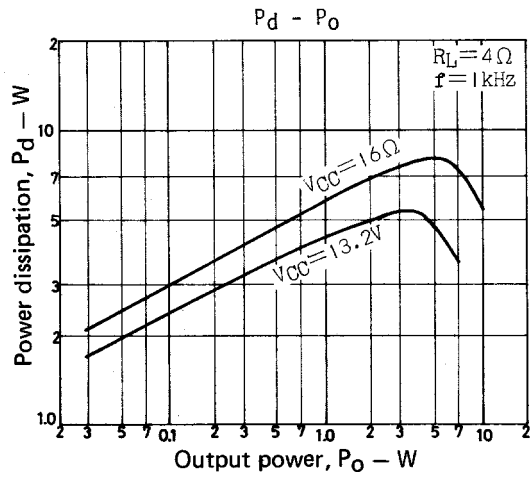
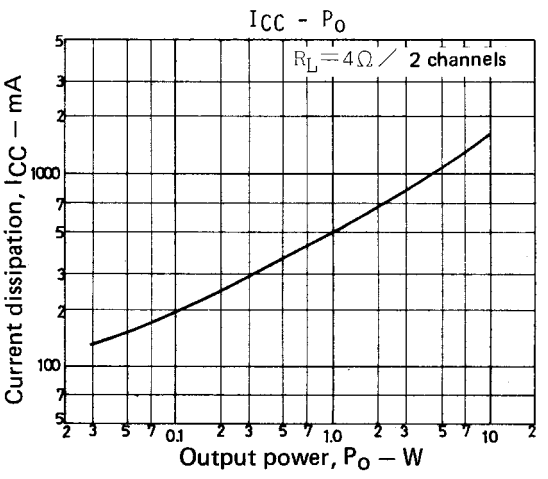
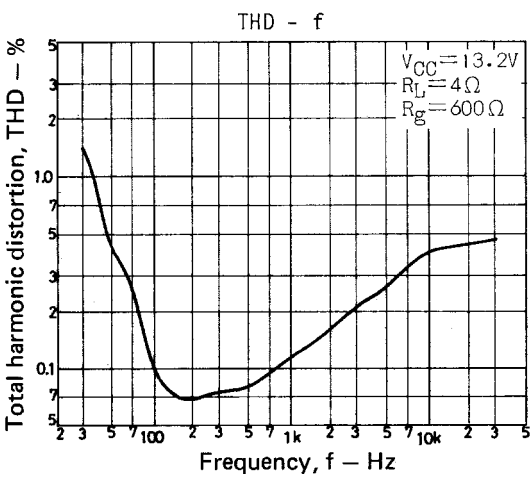
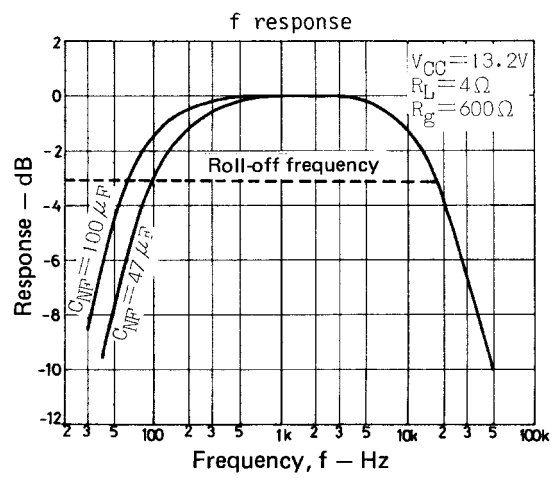
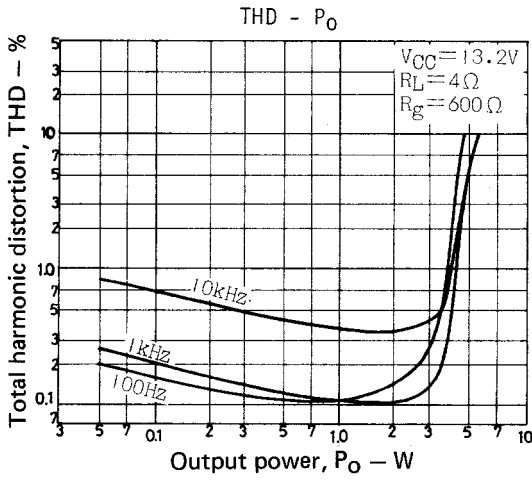
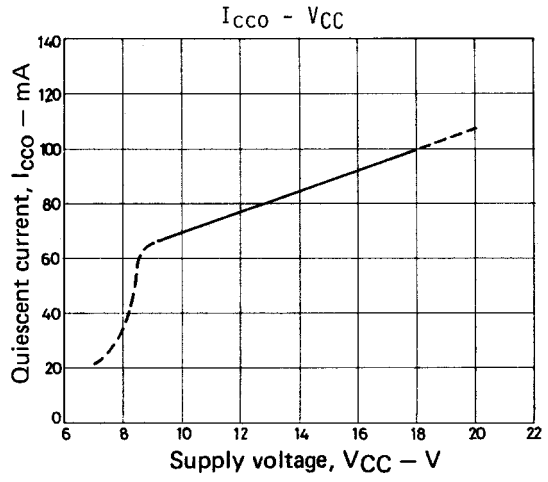
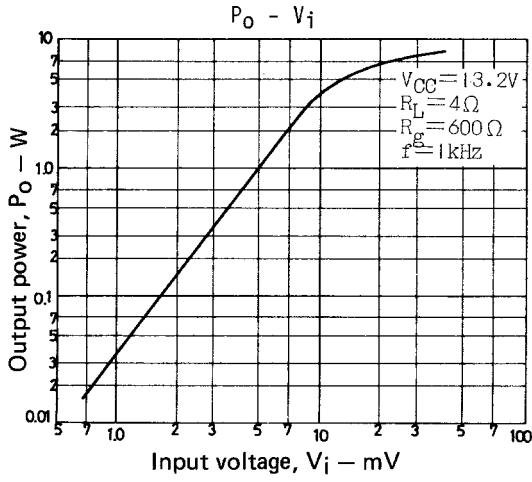

LA4445

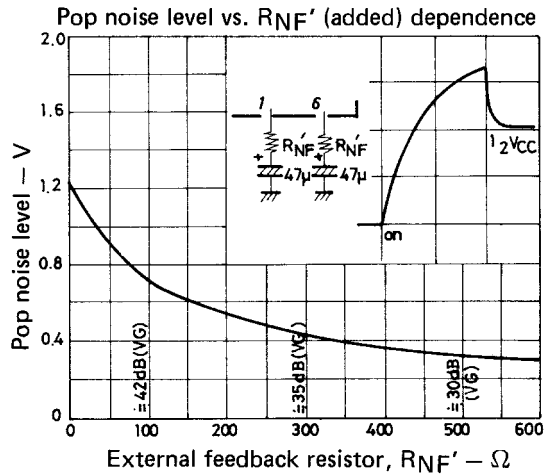
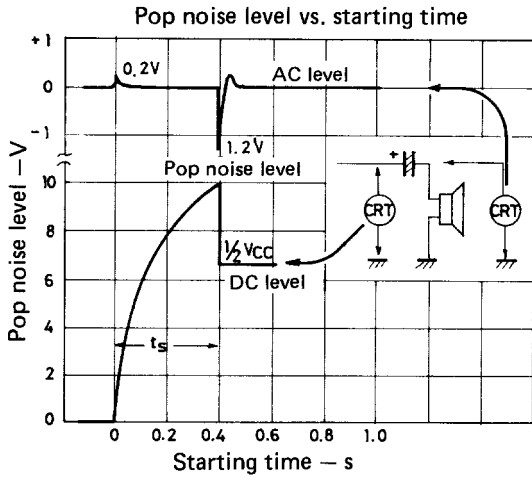
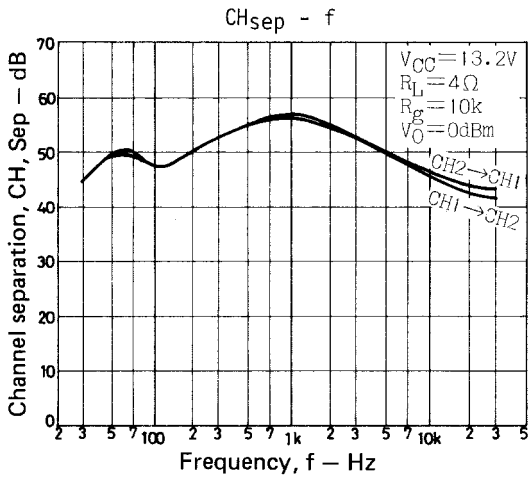
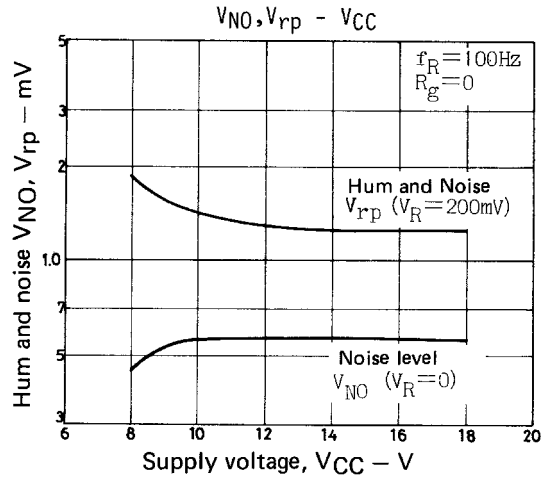
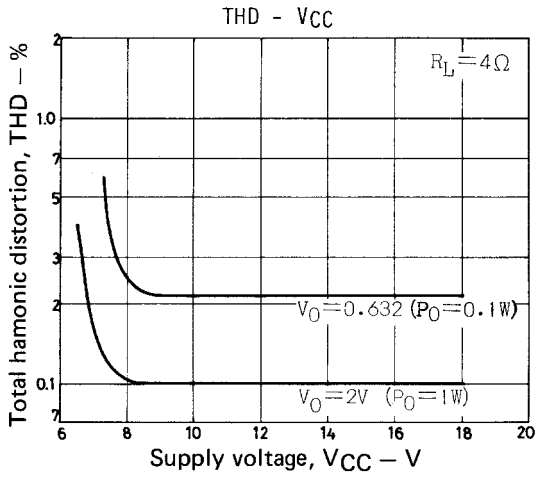

Sample Application Circuit : Bridge connection application

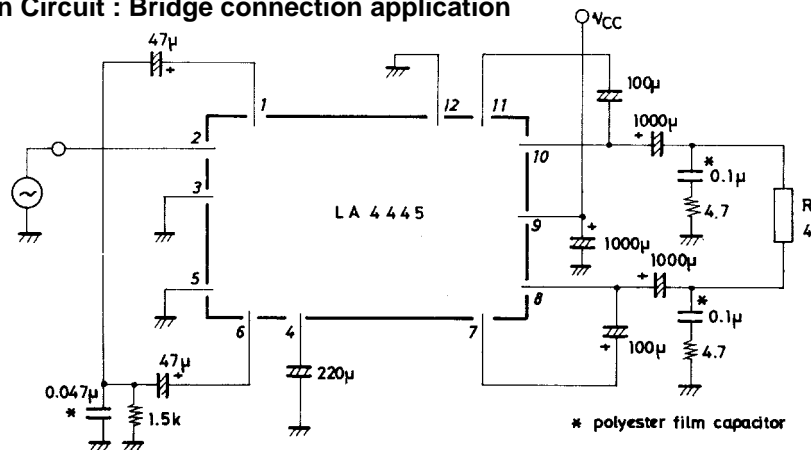

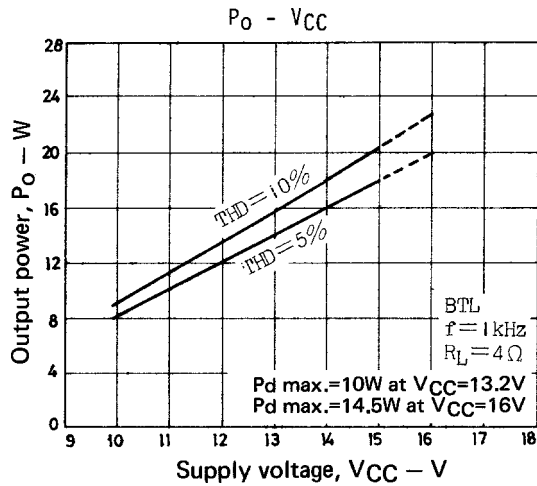

- Specifications of any and all SANYO products described or contained herein stipulate the performance, characteristics, and functions of the described products in the independent state, and are not guarantees of the performance, characteristics, and functions of the described products as mounted in the customer's products or equipment. To verify symptoms and states that cannot be evaluated in an independent device, the customer should always evaluate and test devices mounted in the customer's products or equipment.
- SANYO Electric Co., Ltd. strives to supply high-quality high-reliability products. However, any and all semiconductor products fail with some probability. It is possible that these probabilistic failures could give rise to accidents or events that could endanger human lives, that could give rise to smoke or fire, or that could cause damage to other property. When designing equipment, adopt safety measures so that these kinds of accidents or events cannot occur. Such measures include but are not limited to protective circuits and error prevention circuits for safe design, redundant design, and structural design.
- In the event that any or all SANYO products (including technical data, services) described or contained herein are controlled under any of applicable local export control laws and regulations, such products must not be exported without obtaining the export license from the authorities concerned in accordance with the above law.
- No part of this publication may be reproduced or transmitted in any form or by any means, electronic or mechanical, including photocopying and recording, or any information storage or retrieval system, or otherwise, without the prior written permission of SANYO Electric Co., Ltd.
- Any and all information described or contained herein are subject to change without notice due to product/technology improvement, etc. When designing equipment, refer to the "Delivery Specification" for the SANYO product that you intend to use.
- Information (including circuit diagrams and circuit parameters) herein is for example only; it is not guaranteed for volume production. SANYO believes information herein is accurate and reliable, but no guarantees are made or implied regarding its use or any infringements of intellectual property rights or other rights of third parties.

This catalog provides information as of February, 2000. Specifications and information herein are subject to change without notice.