

FEATURES

- **140MHz Bandwidth:** $A_V = 2$, $R_L = 150\Omega$
- **1100V/ μ s Slew Rate**
- Low Cost
- 30mA Output Drive Current
- 0.01% Differential Gain
- 0.01° Differential Phase
- High Input Impedance: $14M\Omega$, 3pF
- Wide Supply Range: $\pm 2V$ to $\pm 15V$
- Shutdown Mode: $I_S < 250\mu A$
- Low Supply Current: $I_S = 10mA$
- Inputs Common Mode to Within 1.5V of Supplies
- Outputs Swing Within 0.8V of Supplies

APPLICATIONS

- Video Amplifiers
- Cable Drivers
- RGB Amplifiers
- Test Equipment Amplifiers
- 50 Ω Buffers for Driving Mixers

DESCRIPTION

The LT1227 is a current feedback amplifier with wide bandwidth and excellent video characteristics. The low differential gain and phase, wide bandwidth, and 30mA output drive current make the LT1227 well suited to drive cables in video systems.

A shutdown feature switches the device into a high impedance, low current mode, allowing multiple devices to be connected in parallel and selected. Input to output isolation in shutdown is 70dB at 10MHz for input amplitudes up to 10V_{p-p}. The shutdown pin interfaces to open collector or open drain logic and takes only 4 μ s to enable or disable.

The LT1227 comes in the industry standard pinout and can upgrade the performance of many older products. For a dual or quad version, see the LT1229/1230 data sheet.

The LT1227 is manufactured on Linear Technology's proprietary complementary bipolar process.

TYPICAL APPLICATION

Video Cable Driver

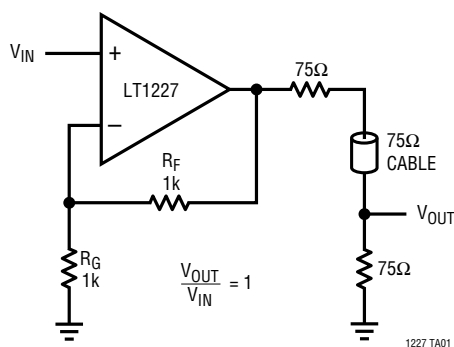

Differential Gain and Phase vs Supply Voltage

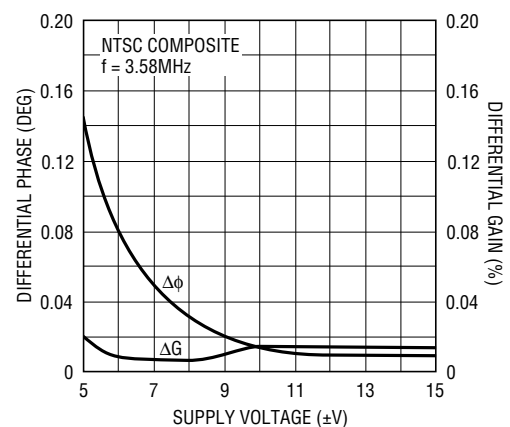

LT1227 • TA02

ABSOLUTE MAXIMUM RATINGS

Supply Voltage	±18V
Input Current	±15mA
Output Short Circuit Duration (Note 1)	Continuous
Operating Temperature Range	
LT1227C	0°C to 70°C
LT1227M	-55°C to 125°C
Storage Temperature Range	-65°C to 150°C
Junction Temperature	
Plastic Package	150°C
Ceramic Package	175°C
Lead Temperature (Soldering, 10 sec.)	300°C

PACKAGE/ORDER INFORMATION

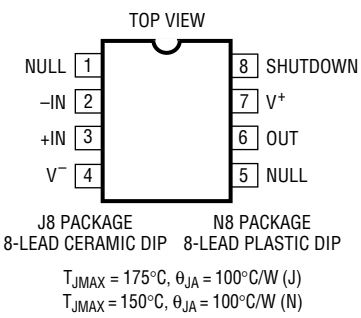
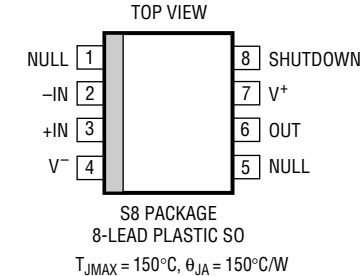
	ORDER PART NUMBER
	LT1227MJ8 LT1227CN8
	LT1227CS8
	S8 PART MARKING 1227

Consult factory for Industrial grade parts.

ELECTRICAL CHARACTERISTICS $V_{CM} = 0, \pm 5V \leq V_S \leq \pm 15V$, pulse tested, unless otherwise noted.

SYMBOL	PARAMETER	CONDITIONS	MIN	TYP	MAX	UNITS
V _{OS}	Input Offset Voltage	T _A = 25°C	●	±3	±10	mV
			●		±15	mV
	Input Offset Voltage Drift		●	10		µV/°C
I _{IN+}	Noninverting Input Current	T _A = 25°C	●	±0.3	±3	µA
			●		±10	µA
I _{IN-}	Inverting Input Current	T _A = 25°C	●	±10	±60	µA
			●		±100	µA
e _n	Input Noise Voltage Density	f = 1kHz, R _F = 1k, R _G = 10Ω, R _S = 0Ω		3.2		nV/√Hz
+i _n	Noninverting Input Noise Current Density	f = 1kHz		1.7		pA/√Hz
-i _n	Inverting Input Noise Current Density	f = 1kHz		32		pA/√Hz
R _{IN}	Input Resistance	V _{IN} = ±13V, V _S = ±15V	●	1.5	14	MΩ
		V _{IN} = ±3V, V _S = ±5V	●	1.5	11	MΩ
C _{IN}	Input Capacitance			3		pF
	Input Voltage Range	V _S = ±15V, T _A = 25°C	●	±13	±13.5	V
			●	±12		V
		V _S = ±5V, T _A = 25°C	●	±3	±3.5	V
			●	±2		V
CMRR	Common-Mode Rejection Ratio	V _S = ±15V, V _{CM} = ±13V, T _A = 25°C	●	55	62	dB
		V _S = ±15V, V _{CM} = ±12V	●	55		dB
		V _S = ±5V, V _{CM} = ±3V, T _A = 25°C	●	55	61	dB
		V _S = ±5V, V _{CM} = ±2V	●	55		dB
	Inverting Input Current Common-Mode Rejection	V _S = ±15V, V _{CM} = ±13V, T _A = 25°C	●	3.5	10	µA/V
			●		10	µA/V
		V _S = ±5V, V _{CM} = ±3V, T _A = 25°C	●	4.5	10	µA/V
			●		10	µA/V

ELECTRICAL CHARACTERISTICS $V_{CM} = 0, \pm 5V \leq V_S \leq \pm 15V$, pulse tested, unless otherwise noted.

SYMBOL	PARAMETER	CONDITIONS	MIN	TYP	MAX	UNITS
PSRR	Power Supply Rejection Ratio	$V_S = \pm 2V$ to $\pm 15V$, $T_A = 25^\circ C$	60	80		dB
		$V_S = \pm 3V$ to $\pm 15V$	60			dB
	Noninverting Input Current Power Supply Rejection	$V_S = \pm 2V$ to $\pm 15V$, $T_A = 25^\circ C$		2	50	nA/V
		$V_S = \pm 3V$ to $\pm 15V$			50	nA/V
	Inverting Input Current Power Supply Rejection	$V_S = \pm 2V$ to $\pm 15V$, $T_A = 25^\circ C$		0.25	5	$\mu A/V$
		$V_S = \pm 3V$ to $\pm 15V$			5	$\mu A/V$
A_V	Large-Signal Voltage Gain	$V_S = \pm 15V$, $V_{OUT} = \pm 10V$, $R_L = 1k$	55	72		dB
		$V_S = \pm 5V$, $V_{OUT} = \pm 2V$, $R_L = 150\Omega$	55	72		dB
R_{OL}	Transresistance, $\Delta V_{OUT}/\Delta I_{IN-}$	$V_S = \pm 15V$, $V_{OUT} = \pm 10V$, $R_L = 1k$	100	270		k Ω
		$V_S = \pm 5V$, $V_{OUT} = \pm 2V$, $R_L = 150\Omega$	100	240		k Ω
V_{OUT}	Maximum Output Voltage Swing	$V_S = \pm 15V$, $R_L = 400\Omega$, $T_A = 25^\circ C$	± 12	± 13.5		V
			± 10			V
		$V_S = \pm 5V$, $R_L = 150\Omega$, $T_A = 25^\circ C$	± 3	± 3.7		V
			± 2.5			V
I_{OUT}	Maximum Output Current	$R_L = 0\Omega$, $T_A = 25^\circ C$	30	60		mA
I_S	Supply Current (Note 2)	$V_S = \pm 15V$, $V_{OUT} = 0V$, $T_A = 25^\circ C$		10	15.0	mA
					17.5	mA
	Positive Supply Current, Shutdown	$V_S = \pm 15V$, Pin 8 Voltage = 0V, $T_A = 25^\circ C$		120	300	μA
					500	μA
I_8	Shutdown Pin Current (Note 3)	$V_S = \pm 15V$			300	μA
	Output Leakage Current, Shutdown	$V_S = \pm 15V$, Pin 8 Voltage = 0V, $T_A = 25^\circ C$			10	μA
SR	Slew Rate (Notes 4 and 5)	$T_A = 25^\circ C$	500	1100		V/ μs
t_r, t_f	Rise and Fall Time, $V_{OUT} = 1V_{P-P}$	$V_S = \pm 5V$, $R_F = 1k$, $R_G = 1k$, $R_L = 150\Omega$		8.7		ns
BW	Small-Signal Bandwidth	$V_S = \pm 15V$, $R_F = 1k$, $R_G = 1k$, $R_L = 150\Omega$		140		MHz
t_r, t_f	Small-Signal Rise and Fall Time	$V_S = \pm 15V$, $R_F = 1k$, $R_G = 1k$, $R_L = 100\Omega$		3.3		ns
		Propagation Delay	$V_S = \pm 15V$, $R_F = 1k$, $R_G = 1k$, $R_L = 100\Omega$		3.4	ns
	Small-Signal Overshoot	$V_S = \pm 15V$, $R_F = 1k$, $R_G = 1k$, $R_L = 100\Omega$		5		%
t_S	Settling Time	0.1%, $V_{OUT} = 10V$, $R_F = 1k$, $R_G = 1k$, $R_L = 1k$		50		ns
		Differential Gain (Note 6)	$V_S = \pm 15V$, $R_F = 1k$, $R_G = 1k$, $R_L = 150\Omega$		0.014	%
		$V_S = \pm 15V$, $R_F = 1k$, $R_G = 1k$, $R_L = 1k$		0.010		%
	Differential Phase (Note 6)	$V_S = \pm 15V$, $R_F = 1k$, $R_G = 1k$, $R_L = 150\Omega$		0.010		DEG
		$V_S = \pm 15V$, $R_F = 1k$, $R_G = 1k$, $R_L = 1k$		0.013		DEG

The ● denotes specifications which apply over the operating temperature range.

Note 1: A heat sink may be required depending on the power supply voltage.

Note 2: The supply current of the LT1227 has a negative temperature coefficient. For more information, see Typical Performance Characteristics curves.

Note 3: Ramp pin 8 voltage down from 15V while measuring I_S . When I_S drops to less than 0.5mA, measure pin 8 current.

Note 4: Slew rate is measured at $\pm 5V$ on a $\pm 10V$ output signal while operating on $\pm 15V$ supplies with $R_F = 2k$, $R_G = 220\Omega$ and $R_L = 400\Omega$.

Note 5: AC parameters are 100% tested on the ceramic and plastic DIP package parts (J and N suffix) and are sample tested on every lot of the SO packaged parts (S suffix).

Note 6: NTSC composite video with an output level of 2V.

TYPICAL PERFORMANCE CHARACTERISTICS

Voltage Gain and Phase vs Frequency, Gain = 6dB

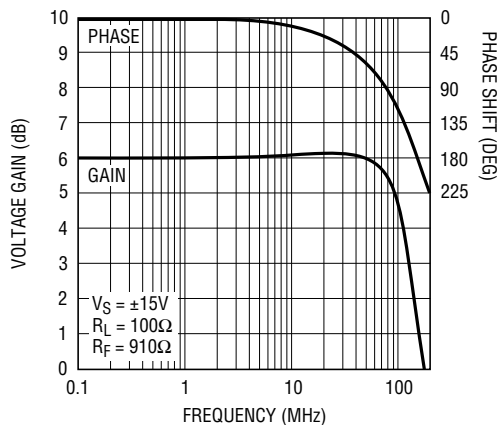

LT1227 • TPC01

-3dB Bandwidth vs Supply Voltage, Voltage, Gain = 2, $R_L = 100\Omega$

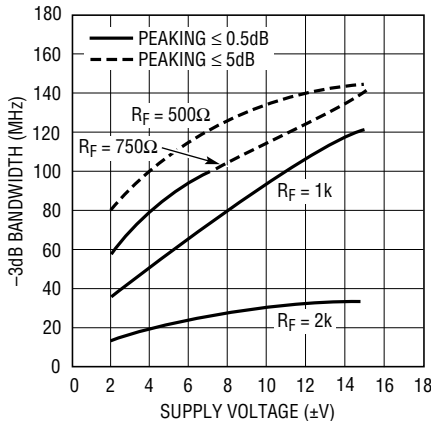

LT1227 • TPC02

-3dB Bandwidth vs Supply Voltage, Voltage, Gain = 2, $R_L = 1k$

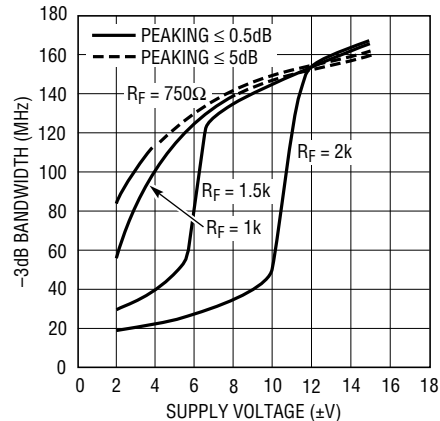

LT1227 • TPC03

Voltage Gain and Phase vs Frequency, Gain = 20dB

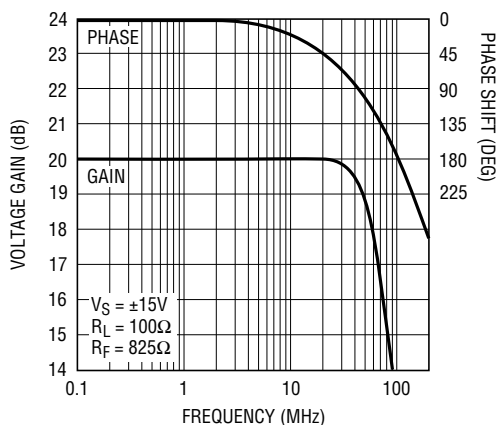

LT1227 • TPC04

-3dB Bandwidth vs Supply Voltage, Voltage, Gain = 10, $R_L = 100\Omega$

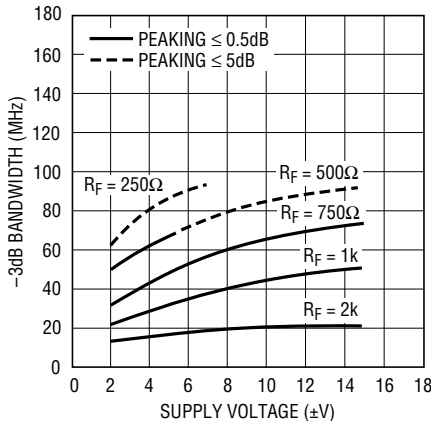

LT1227 • TPC05

-3dB Bandwidth vs Supply Voltage, Voltage, Gain = 10, $R_L = 1k$

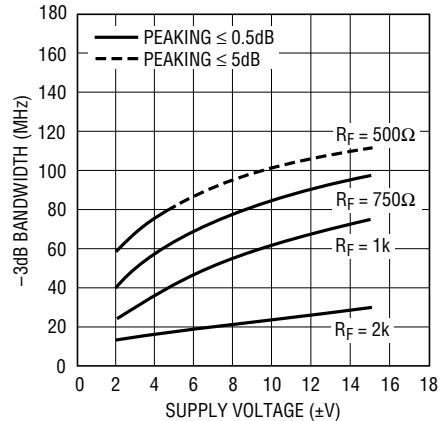

LT1227 • TPC06

Voltage Gain and Phase vs Frequency, Gain = 40dB

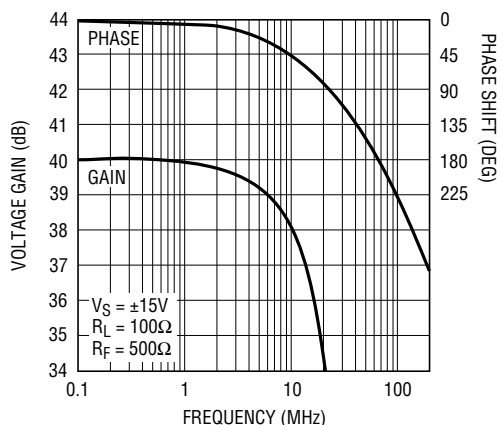

LT1227 • TPC07

-3dB Bandwidth vs Supply Voltage, Voltage, Gain = 100, $R_L = 100\Omega$

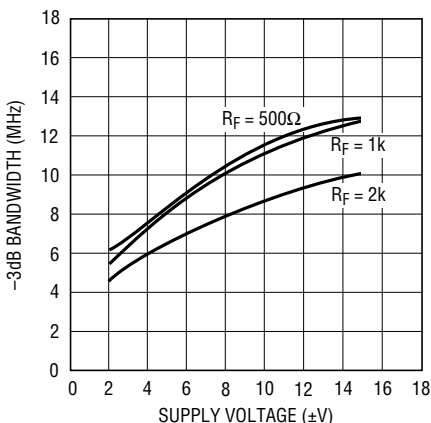

LT1227 • TPC08

-3dB Bandwidth vs Supply Voltage, Voltage, Gain = 100, $R_L = 1k$

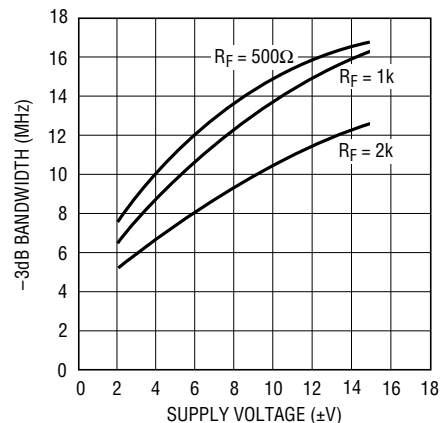

LT1227 • TPC09

TYPICAL PERFORMANCE CHARACTERISTICS

Maximum Capacitive Load vs Feedback Resistor

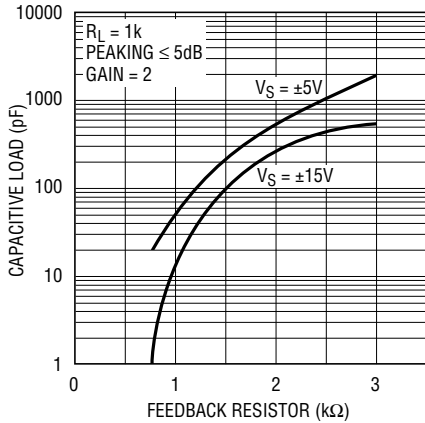

LT1227 • TPC10

Total Harmonic Distortion vs Frequency

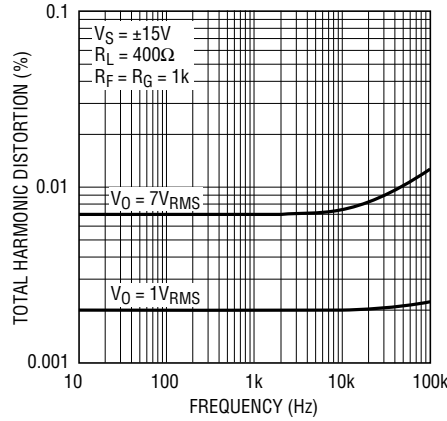

LT1227 • TPC11

Maximum Undistorted Output vs Frequency

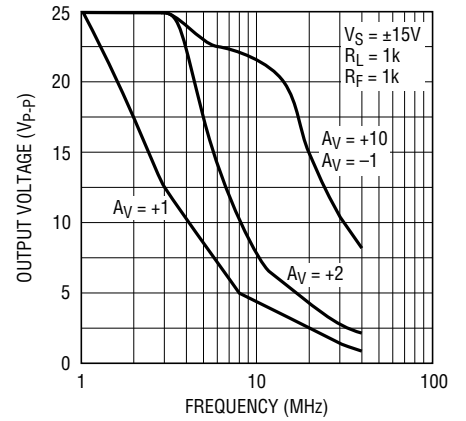

LT1227 • TPC12

Input Common Mode Limit vs Temperature

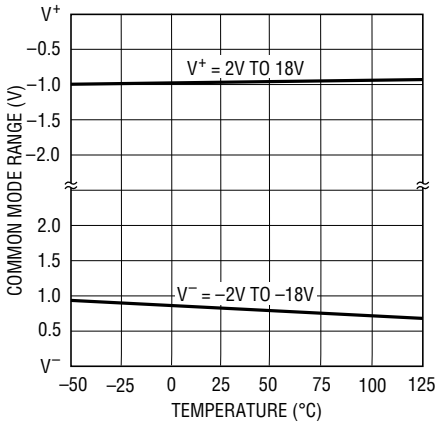

LT1227 • TPC13

Output Saturation Voltage vs Temperature

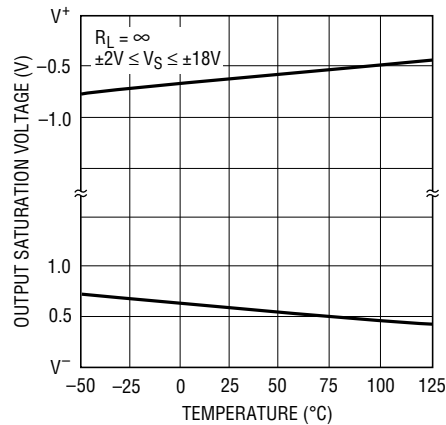

LT1227 • TPC14

Output Short-Circuit Current vs Junction Temperature

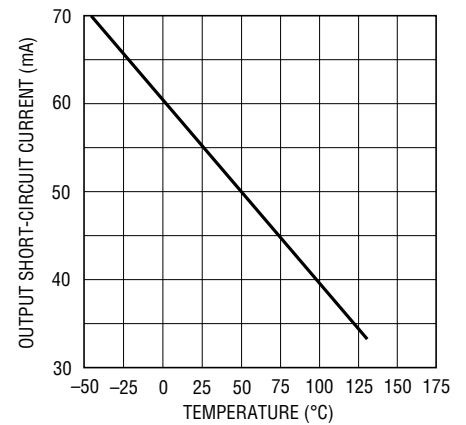

LT1227 • TPC15

Spot Noise Voltage and Current vs Frequency

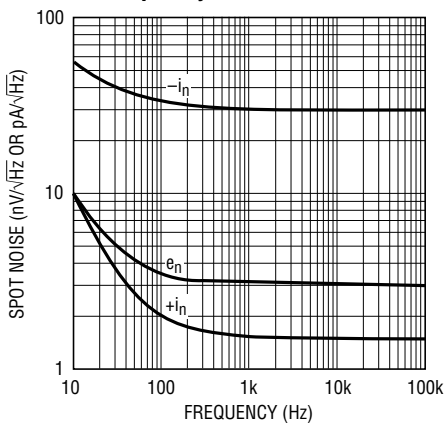

LT1227 • TPC16

Power Supply Rejection vs Frequency

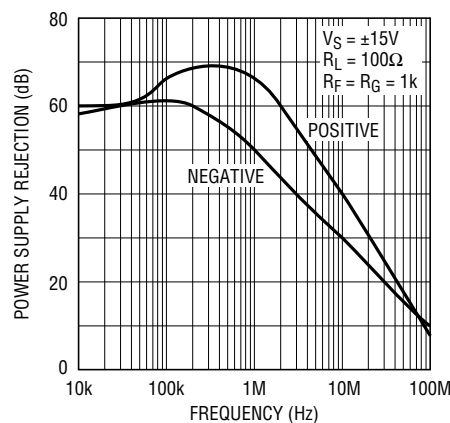

LT1227 • TPC17

Output Impedance vs Frequency

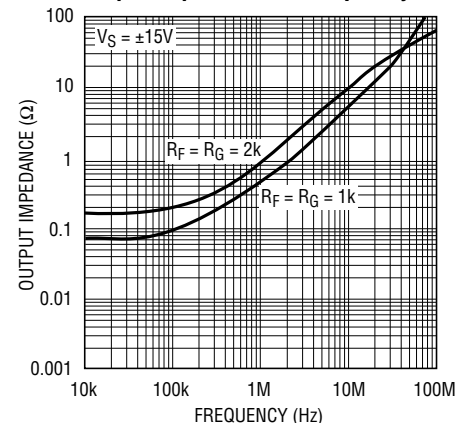

LT1227 • TPC18

TYPICAL PERFORMANCE CHARACTERISTICS

Settling Time to 10mV vs Output Step

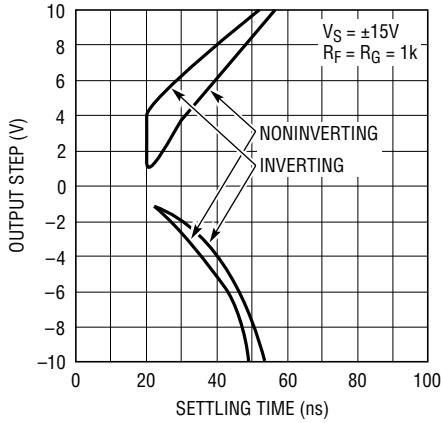

LT1227 • TPC19

Settling Time to 1mV vs Output Step

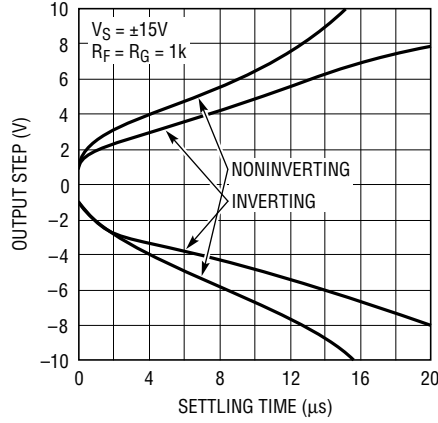

LT1227 • TPC20

Supply Current vs Supply Voltage

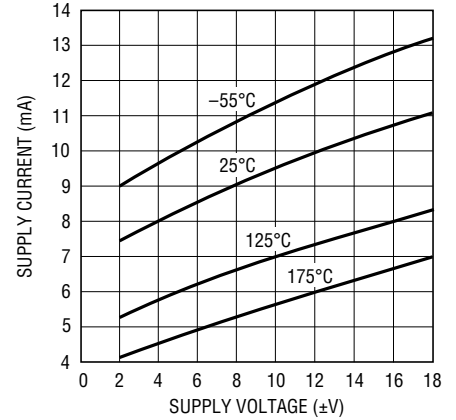

LT1227 • TPC21

Output Impedance in Shutdown vs Frequency

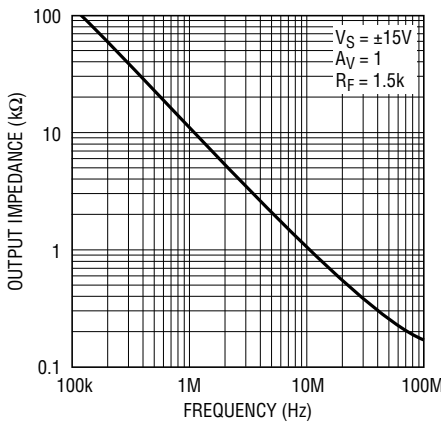

LT1227 • TPC22

Differential Phase vs Frequency

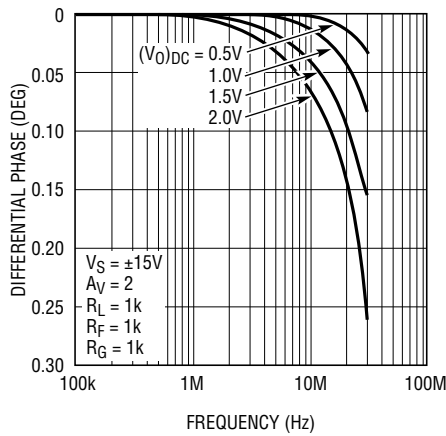

LT1227 • TPC23

Differential Gain vs Frequency

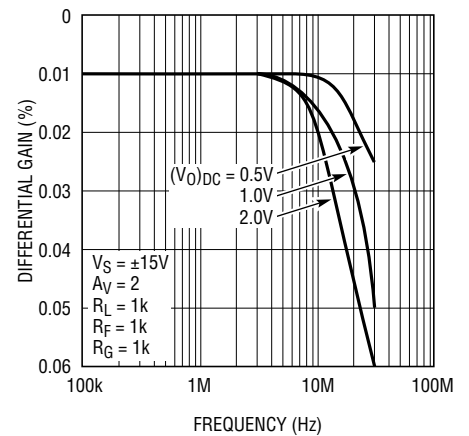

LT1227 • TPC24

2nd and 3rd Harmonic Distortion vs Frequency

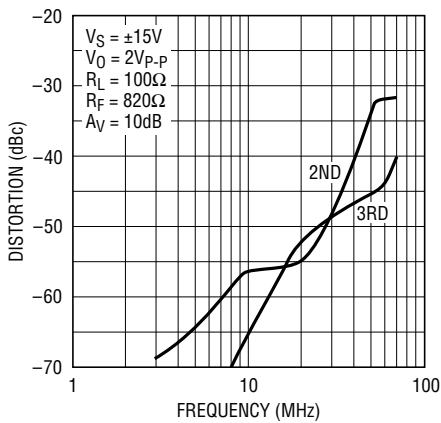

LT1227 • TPC25

3rd Order Intercept vs Frequency

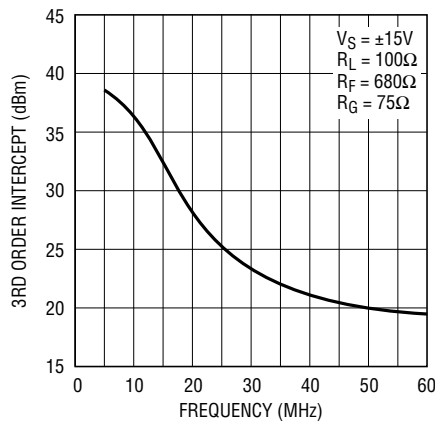

LT1227 • TPC26

Test Circuit for 3rd Order Intercept

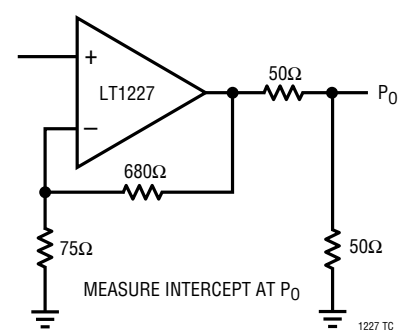

1227 TC

SIMPLIFIED SCHEMATIC

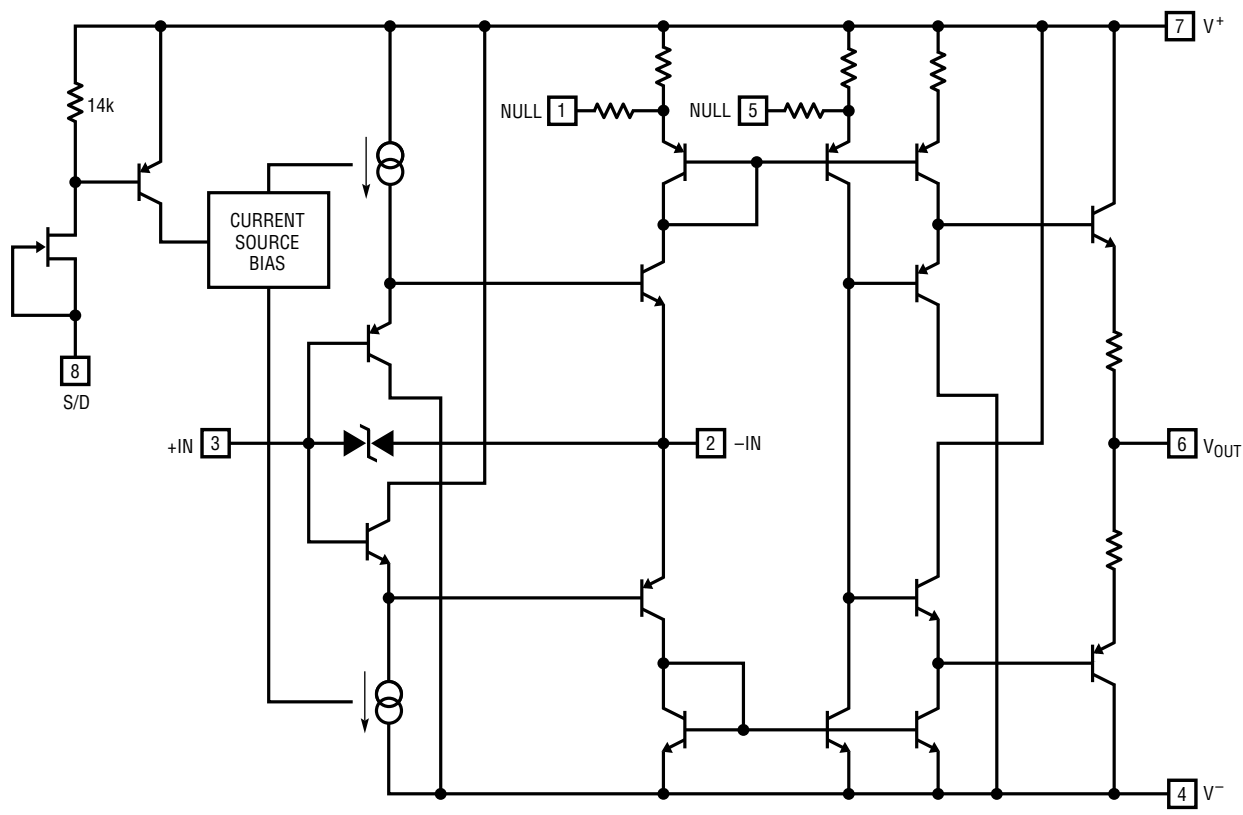

1227 SS

APPLICATIONS INFORMATION

The LT1227 is a very fast current feedback amplifier. Because it is a current feedback amplifier, the bandwidth is maintained over a wide range of voltage gains. The amplifier is designed to drive low impedance loads such as cables with excellent linearity at high frequencies.

Feedback Resistor Selection

The small-signal bandwidth of the LT1227 is set by the external feedback resistors and the internal junction capacitors. As a result, the bandwidth is a function of the supply voltage, the value of the feedback resistor, the closed-loop gain and load resistor. The characteristic curves of Bandwidth vs Supply Voltage show the effect of a heavy load (100Ω) and a light load (1k). These curves use a solid line when the response has less than 0.5dB of peaking and a dashed line when the response has 0.5dB to

5dB of peaking. The curves stop where the response has more than 5dB of peaking.

At a gain of two, on ±15V supplies with a 1k feedback resistor, the bandwidth into a light load is over 140MHz, but into a heavy load the bandwidth reduces to 120MHz. The loading has this effect because there is a mild resonance in the output stage that enhances the bandwidth at light loads but has its Q reduced by the heavy load. This enhancement is only useful at low gain settings; at a gain of ten it does not boost the bandwidth. At unity gain, the enhancement is so effective the value of the feedback resistor has very little effect. At very high closed-loop gains, the bandwidth is limited by the gain bandwidth product of about 1GHz. The curves show that the bandwidth at a closed-loop gain of 100 is 12MHz, only one tenth what it is at a gain of two.

APPLICATIONS INFORMATION

Small-Signal Rise Time, $A_V = +2$

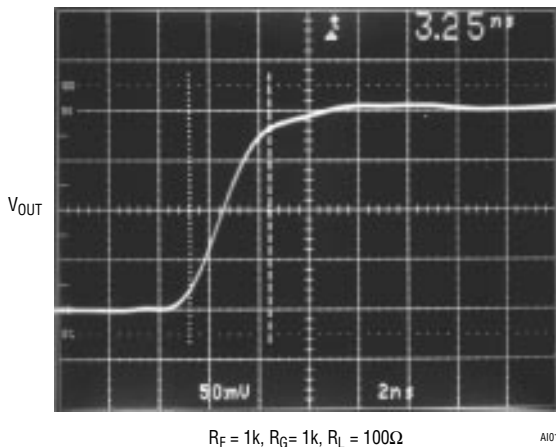

Capacitance on the Inverting Input

Current feedback amplifiers require resistive feedback from the output to the inverting input for stable operation. Take care to minimize the stray capacitance between the output and the inverting input. Capacitance on the inverting input to ground will cause peaking in the frequency response (and overshoot in the transient response), but it does not degrade the stability of the amplifier.

Capacitive Loads

The LT1227 can drive capacitive loads directly when the proper value of feedback resistor is used. The graph of Maximum Capacitive Load vs Feedback Resistor should be used to select the appropriate value. The value shown is for 5dB peaking when driving a 1k load at a gain of 2. This is a worst case condition, the amplifier is more stable at higher gains and driving heavier loads. Alternatively, a small resistor (10Ω to 20Ω) can be put in series with the output to isolate the capacitive load from the amplifier output. This has the advantage that the amplifier bandwidth is only reduced when the capacitive load is present and the disadvantage that the gain is a function of the load resistance.

Power Supplies

The LT1227 will operate from single or split supplies from $\pm 2V$ (4V total) to $\pm 15V$ (30V total). It is not necessary to use equal value split supplies, however the offset voltage

and inverting input bias current will change. The offset voltage changes about 500μV per volt of supply mismatch. The inverting bias current can change as much as 5.0μA per volt of supply mismatch, though typically the change is less than 0.5μA per volt.

Slew Rate

The slew rate of a current feedback amplifier is not independent of the amplifier gain configuration the way slew rate is in a traditional op amp. This is because both the input stage and the output stage have slew rate limitations. In the inverting mode, and for higher gains in the noninverting mode, the signal amplitude between the input pins is small and the overall slew rate is that of the output stage. For gains less than ten in the noninverting mode, the overall slew rate is limited by the input stage.

The input stage slew rate of the LT1227 is approximately 125V/μs and is set by internal currents and capacitances. The output slew rate is set by the value of the feedback resistors and the internal capacitances. At a gain of ten with a 1k feedback resistor and $\pm 15V$ supplies, the output slew rate is typically 1100V/μs. Larger feedback resistors will reduce the slew rate as will lower supply voltages, similar to the way the bandwidth is reduced.

The graph of Maximum Undistorted Output vs Frequency relates the slew rate limitations to sinusoidal inputs for various gain configurations.

Large-Signal Transient Response, $A_V = +10$

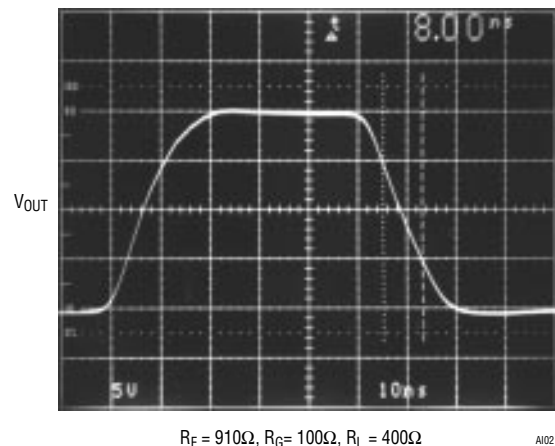

APPLICATIONS INFORMATION

Large-Signal Transient Response, $A_V = +2$

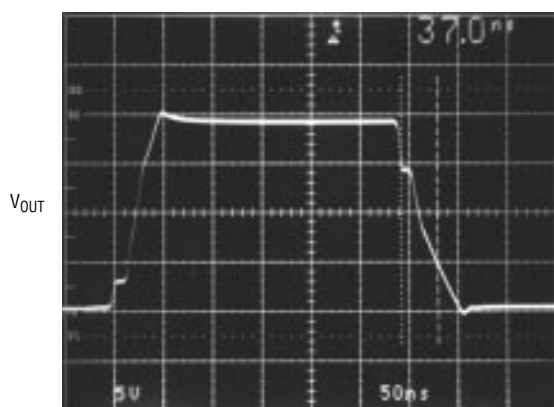

$R_F = 1k, R_G = 1k, R_L = 400\Omega$ A103

Large-Signal Transient Response, $A_V = -2$

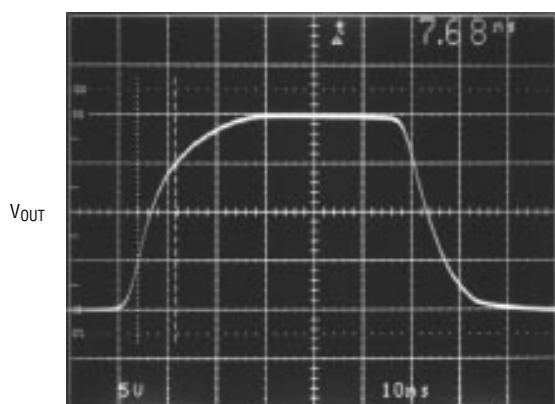

$R_F = 1k, R_G = 510\Omega, R_L = 400\Omega$ A104

Settling Time

The characteristic curves show that the LT1227 amplifier settles to within 10mV of final value in 40ns to 55ns for any output step up to 10V. The curve of settling to 1mV of final value shows that there is a slower thermal contribution up to 20 μ s. The thermal settling component comes from the output and the input stage. The output contributes just under 1mV per volt of output change and the input contributes 300 μ V per volt of input change. Fortunately the input thermal tends to cancel the output thermal. For this reason the noninverting gain of two configuration settles faster than the inverting gain of one.

Shutdown

The LT1227 has a high impedance, low supply current mode which is controlled by pin 8. In the shutdown mode, the output looks like a 12pF capacitor and the supply current drops to approximately the pin 8 current. The shutdown pin is referenced to the positive supply through an internal pullup circuit (see the simplified schematic). Pulling a current of greater than 50 μ A from pin 8 will put the device into the shutdown mode. An easy way to force shutdown is to ground pin 8, using open drain (collector) logic. Because the pin is referenced to the positive supply, the logic used should have a breakdown voltage of greater than the positive supply voltage. No other circuitry is necessary as an internal JFET limits the pin 8 current to about 100 μ A. When pin 8 is open, the LT1227 operates normally.

Differential Input Signal Swing

The differential input swing is limited to about $\pm 6V$ by an ESD protection device connected between the inputs. In normal operation, the differential voltage between the input pins is small, so this clamp has no effect; however, in the shutdown mode, the differential swing can be the same as the input swing. The clamp voltage will then set the maximum allowable input voltage. To allow for some margin, it is recommended that the input signal be less than $\pm 5V$ when the device is shutdown.

Offset Adjust

Pins 1 and 5 are provided for offset nulling. A small current to V^+ or ground will compensate for DC offsets in the device. The pins are referenced to the positive supply (see the simplified schematic) and should be left open if unused. The offset adjust pins act primarily on the inverting input bias current. A 10k pot connected to pins 1 and 5 with the wiper connected to V^+ will null out the bias current, but will not affect the offset voltage much. Since the output offset is

$$V_O \cong A_V \cdot V_{OS} + (I_{IN-}) \cdot R_F$$

at higher gains ($A_V > 5$), the V_{OS} term will dominate. To null out the V_{OS} term, use a 10k pot between pins 1 and 5 with a 150k resistor from the wiper to ground for 15V split supplies, 47k for 5V split supplies.

TYPICAL APPLICATIONS

MUX Amplifier

The shutdown function can be effectively used to construct a MUX amplifier. A two-channel version is shown, but more inputs could be added with suitable logic. By configuring each amplifier as a unity-gain follower, there is no loading by the feedback network when the amplifier is off. The open drains of the 74C906 buffers are used to interface the 5V logic to the shutdown pin. Feedthrough from the unselected input to the output is -70dB at 10MHz . The differential voltage between MUX inputs V_{IN1} and V_{IN2} appears across the inputs of the shutdown device, this voltage should be less than $\pm 5\text{V}$ to avoid turning on the clamp diodes discussed previously. If the inputs are sinusoidal having a zero DC level, this implies that the amplitude of each input should be less than $5\text{V}_{\text{P-P}}$. The output impedance of the off amplifier remains high until the output level exceeds approximately $6\text{V}_{\text{P-P}}$ at 10MHz , this sets the maximum usable output level. Switching time between inputs is about $4\mu\text{s}$ without an external pullup. Adding a 10k pullup resistor from each shutdown pin to V^+ will reduce the switching time to $2\mu\text{s}$ but will increase the positive supply current in shutdown by 1.5mA .

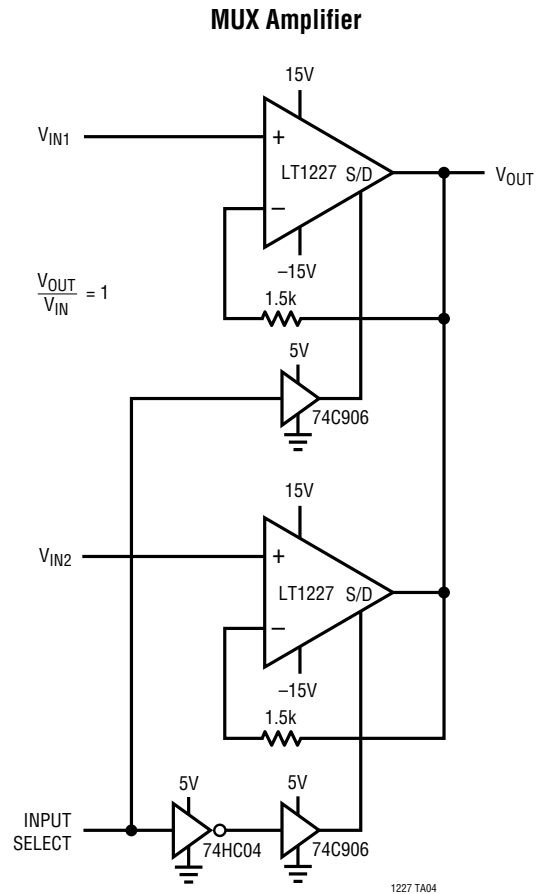

MUX Output

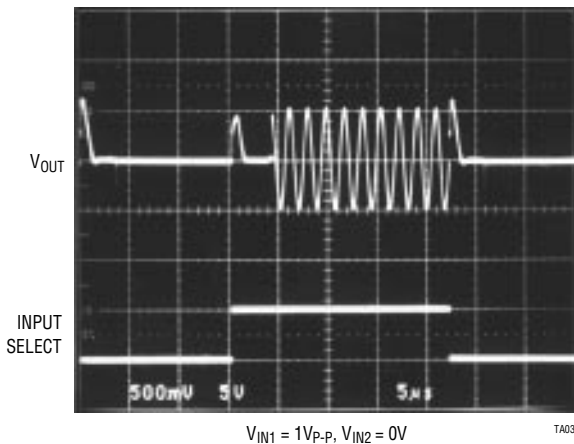

MUX Input Crosstalk vs Frequency

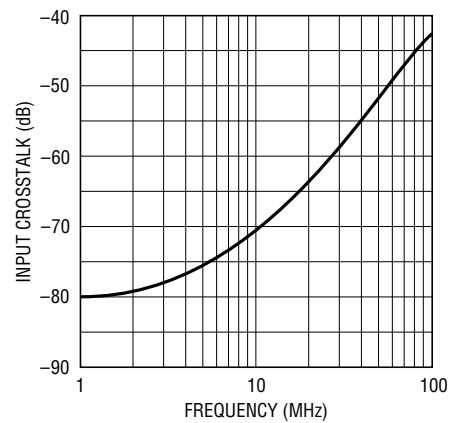

LT1227 TA05

TYPICAL APPLICATIONS

**Single Supply AC-Coupled Amplifier
Noninverting**

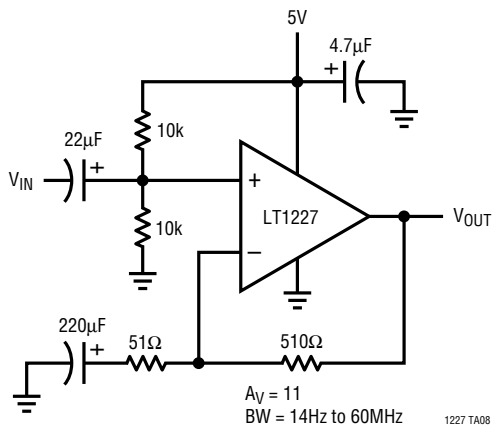

**Single Supply AC-Coupled Amplifier
Inverting**

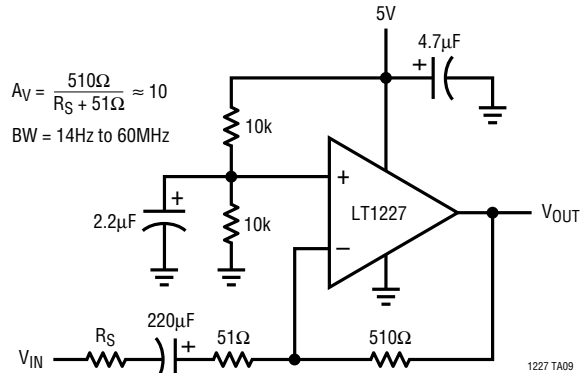

3.58MHz Oscillator

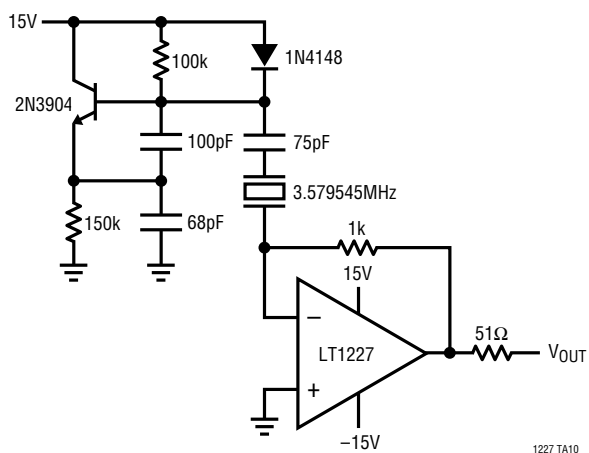

Buffer with DC Nulling Loop

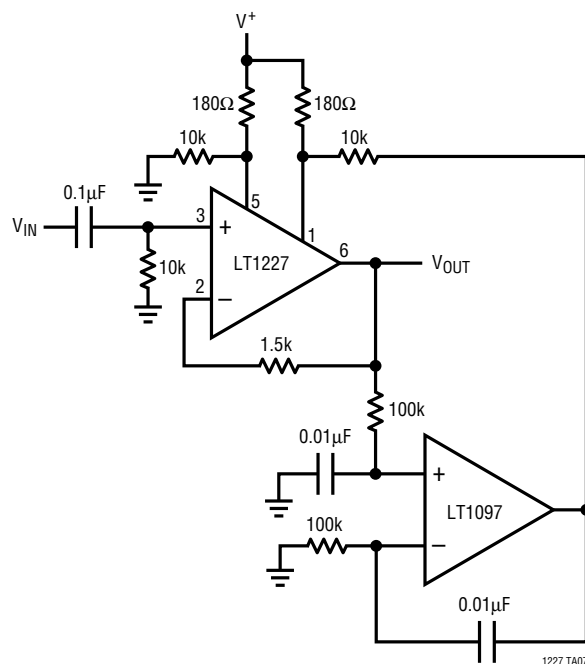

CMOS Logic to Shutdown Interface

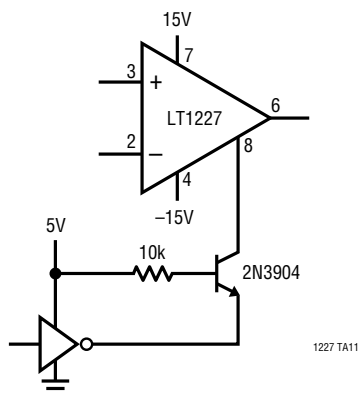

Optional Offset Nulling circuit

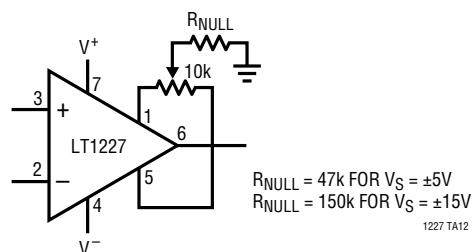

PACKAGE DESCRIPTION

J8 Package 8-Lead Ceramic DIP

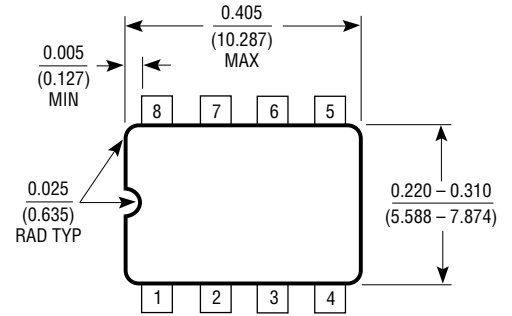
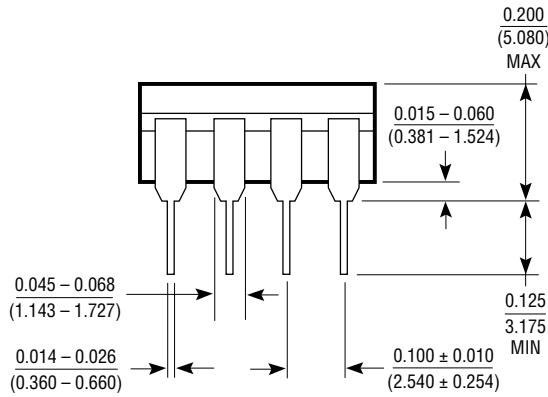
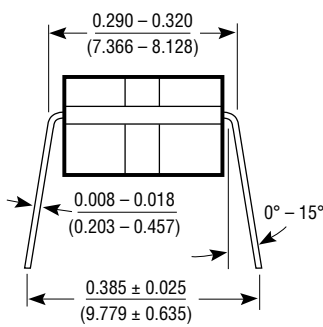

CORNER LEADS OPTION
(4 PLCS)

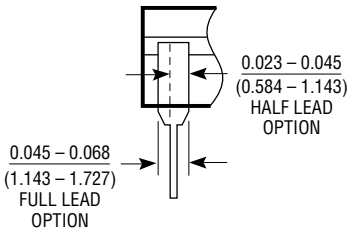

NOTE: LEAD DIMENSIONS APPLY TO SOLDER DIP OR TIN PLATE LEADS.

J8 0293

N8 Package 8-Lead Plastic DIP

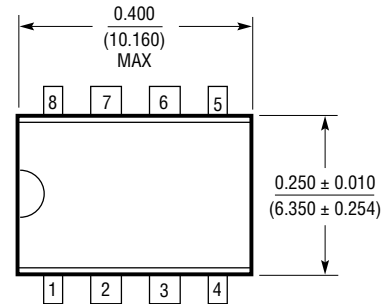
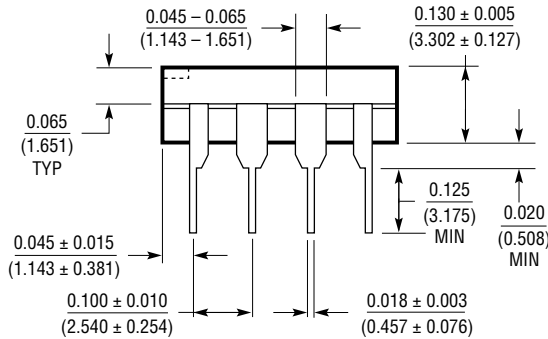
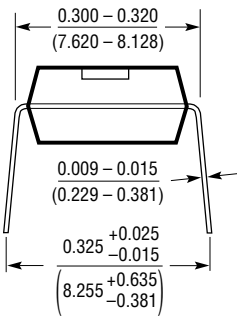

N8 0392

S8 Package 8-Lead Plastic SOIC

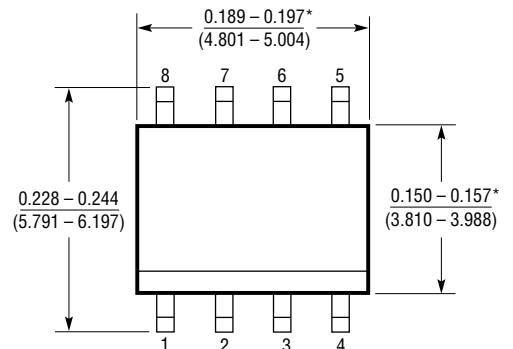
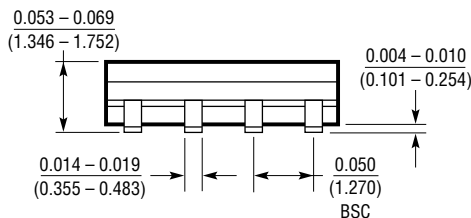
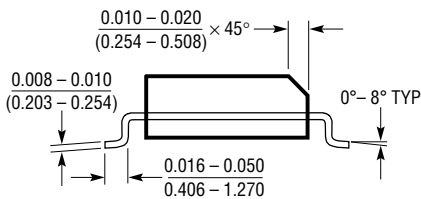

*THESE DIMENSIONS DO NOT INCLUDE MOLD FLASH OR PROTRUSIONS.
MOLD FLASH OR PROTRUSIONS SHALL NOT EXCEED 0.006 INCH (0.15mm).

S08 0294