

128K x 36 Bit Pipelined BurstRAM Synchronous Fast Static RAM

The MCM69P737 is a 4M bit synchronous fast static RAM designed to provide a burstable, high performance, secondary cache for the PowerPC™ and other high performance microprocessors. It is organized as 128K words of 36 bits each. This device integrates input registers, an output register, a 2-bit address counter, and high speed SRAM onto a single monolithic circuit for reduced parts count in cache data RAM applications. Synchronous design allows precise cycle control with the use of an external clock (K).

Addresses (SA), data inputs (DQx), and all control signals except output enable (G) and linear burst order (LBO) are clock (K) controlled through positive-edge-triggered noninverting registers.

Bursts can be initiated with either ADSP or ADSC input pins. Subsequent burst addresses can be generated internally by the MCM69P737 (burst sequence operates in linear or interleaved mode dependent upon the state of LBO) and controlled by the burst address advance (ADV) input pin.

Write cycles are internally self-timed and are initiated by the rising edge of the clock (K) input. This feature eliminates complex off-chip write pulse generation and provides increased timing flexibility for incoming signals.

Synchronous byte write (SBx), synchronous global write (SGW), and synchronous write enable (SW) are provided to allow writes to either individual bytes or to all bytes. The four bytes are designated as "a", "b", "c", and "d". SBa controls DQa, SBb controls DQb, etc. Individual bytes are written if the selected byte writes SBx are asserted with SW. All bytes are written if either SGW is asserted or if all SBx and SW are asserted.

For read cycles, pipelined SRAMs output data is temporarily stored by an edge-triggered output register and then released to the output buffers at the next rising edge of clock (K).

The MCM69P737 operates from a 3.3 V core power supply and all outputs operate on a 2.5 V or 3.3 V power supply. All inputs and outputs are JEDEC standard JESD8-5 compatible.

- MCM69P737-3.5: 3.5 ns Access/6 ns Cycle (166 MHz)
MCM69P737-3.8: 3.8 ns Access/6.7 ns Cycle (150 MHz)
MCM69P737-4: 4 ns Access/7.5 ns Cycle (133 MHz)
- 3.3 V + 10%, - 5% Core Power Supply, 2.5 V or 3.3 V I/O Supply
- ADSP, ADSC, and ADV Burst Control Pins
- Selectable Burst Sequencing Order (Linear/Interleaved)
- Single-Cycle Deselect Timing
- Internally Self-Timed Write Cycle
- Byte Write and Global Write Control
- PB1 Version 2.0 Compatible
- JEDEC Standard 119-Pin PBGA and 100-Pin TQFP Packages

MCM69P737

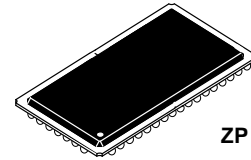

ZP PACKAGE
PBGA
CASE 999-02

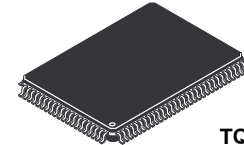

TQ PACKAGE
TQFP
CASE 983A-01

The PowerPC name is a trademark of IBM Corp., used under license therefrom.



FUNCTIONAL BLOCK DIAGRAM

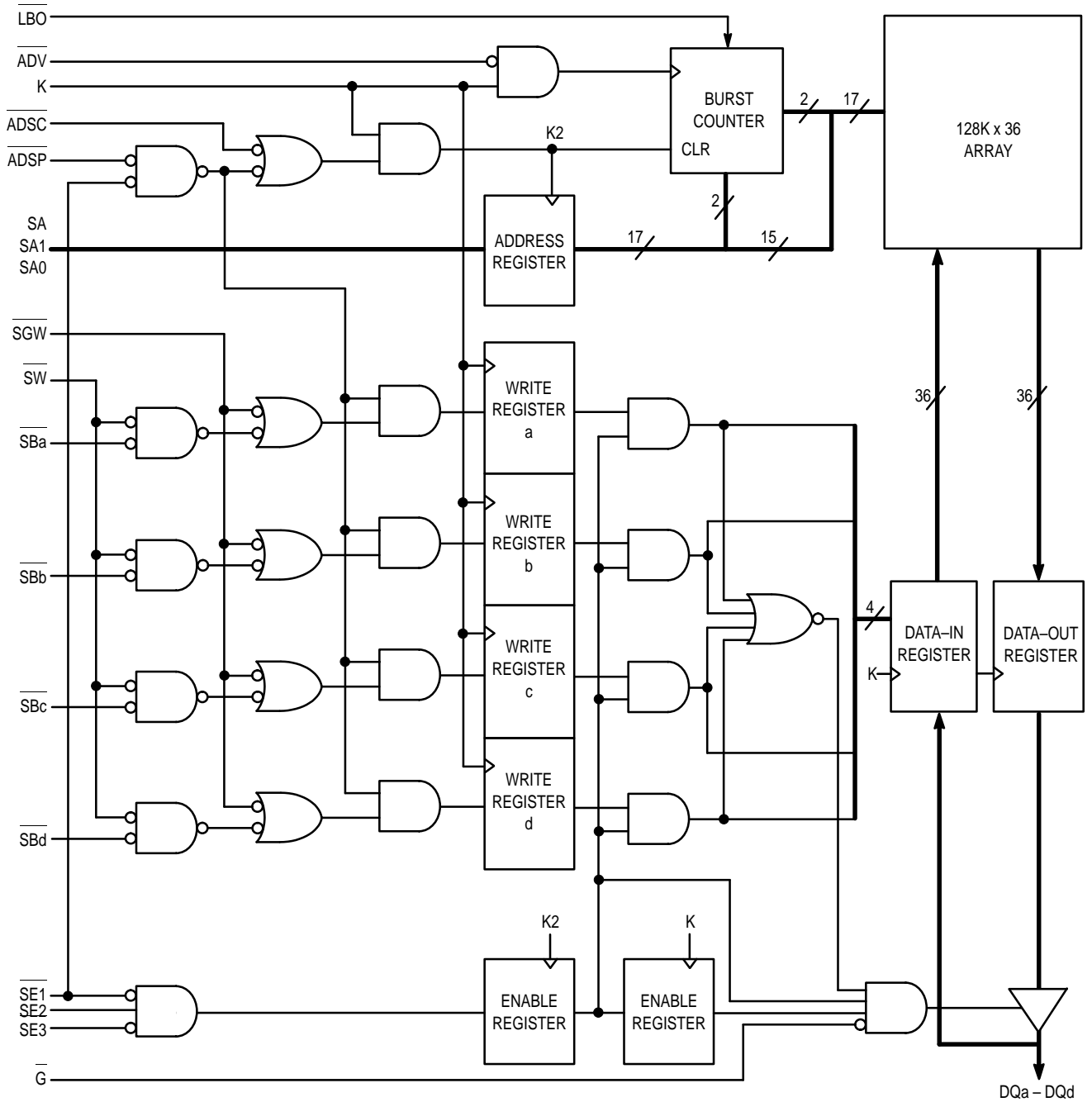

PBGA PIN DESCRIPTIONS

| Pin Locations | Symbol | Type | Description |
|--|------------------|--------|---|
| 4B | ADSC | Input | Synchronous Address Status Controller: Active low, interrupts any ongoing burst and latches a new external address. Used to initiate a READ, WRITE, or chip deselect. |
| 4A | ADSP | Input | Synchronous Address Status Processor: Active low, interrupts any ongoing burst and latches a new external address. Used to initiate a new READ, WRITE, or chip deselect (exception — chip deselect does not occur when ADSP is asserted and SE1 is high). |
| 4G | ADV | Input | Synchronous Address Advance: Increments address count in accordance with counter type selected (linear/interleaved). |
| (a) 6K, 7K, 6L, 7L, 6M, 6N, 7N, 6P, 7P (b) 6D, 7D, 6E, 7E, 6F, 6G, 7G, 6H, 7H (c) 1D, 2D, 1E, 2E, 2F, 1G, 2G, 1H, 2H (d) 1K, 2K, 1L, 2L, 2M, 1N, 2N, 1P, 2P | DQx | I/O | Synchronous Data I/O: "x" refers to the byte being read or written (byte a, b, c, d). |
| 4F | G | Input | Asynchronous Output Enable Input: Low — enables output buffers (DQx pins). High — DQx pins are high impedance. |
| 4K | K | Input | Clock: This signal registers the address, data in, and all control signals except G and LBO. |
| 3R | LBO | Input | Linear Burst Order Input: This pin must remain in steady state (this signal not registered or latched). It must be tied high or low. Low — linear burst counter (68K/PowerPC). High — interleaved burst counter (486/i960/Pentium). |
| 2A, 3A, 5A, 6A, 3B, 5B, 2C, 3C, 5C, 6C, 2R, 6R, 3T, 4T, 5T | SA | Input | Synchronous Address Inputs: These inputs are registered and must meet setup and hold times. |
| 4N, 4P | SA1, SA0 | Input | Synchronous Address Inputs: These pins must be wired to the two LSBs of the address bus for proper burst operation. These inputs are registered and must meet setup and hold times. |
| 5L, 5G, 3G, 3L (a) (b) (c) (d) | SBx | Input | Synchronous Byte Write Inputs: "x" refers to the byte being written (byte a, b, c, d). SGW overrides SBx. |
| 4E | SE1 | Input | Synchronous Chip Enable: Active low to enable chip. _____ Negated high — blocks ADSP or deselects chip when ADSC is asserted. |
| 2B | SE2 | Input | Synchronous Chip Enable: Active high for depth expansion. |
| 6B | SE3 | Input | Synchronous Chip Enable: Active low for depth expansion. |
| 4H | SGW | Input | Synchronous Global Write: This signal writes all bytes regardless of the status of the SBx and SW signals. If only byte write signals SBx are being used, tie this pin high. |
| 4M | SW | Input | Synchronous Write: This signal writes only those bytes that have been selected using the byte write SBx pins. If only byte write signals SBx are being used, tie this pin low. |
| 4C, 2J, 4J, 6J, 4R | V _{DD} | Supply | Core Power Supply. |
| 1A, 7A, 1F, 7F, 1J, 7J, 1M, 7M, 1U, 7U | V _{DDQ} | Supply | I/O Power Supply. |
| 3D, 5D, 3E, 5E, 3F, 5F, 3H, 5H, 3K, 5K, 3M, 5M, 3N, 5N, 3P, 5P | V _{SS} | Supply | Ground. |
| 1B, 7B, 1C, 7C, 4D, 3J, 5J, 4L, 1R, 5R, 7R, 1T, 2T, 6T, 7T, 2U, 3U, 4U, 5U, 6U | NC | — | No Connection: There is no connection to the chip. |

TQFP PIN DESCRIPTIONS

| Pin Locations | Symbol | Type | Description |
|---|------------------|--------|---|
| 85 | ADSC | Input | Synchronous Address Status Controller: Active low, interrupts any ongoing burst and latches a new external address. Used to initiate a READ, WRITE, or chip deselect. |
| 84 | ADSP | Input | Synchronous Address Status Processor: Active low, interrupts any ongoing burst and latches a new external address. Used to initiate a new READ, WRITE, or chip deselect (exception — chip deselect does not occur when ADSP is asserted and SE1 is high). |
| 83 | ADV | Input | Synchronous Address Advance: Increments address count in accordance with counter type selected (linear/interleaved). |
| (a) 51, 52, 53, 56, 57, 58, 59, 62, 63 (b) 68, 69, 72, 73, 74, 75, 78, 79, 80 (c) 1, 2, 3, 6, 7, 8, 9, 12, 13 (d) 18, 19, 22, 23, 24, 25, 28, 29, 30 | DQx | I/O | Synchronous Data I/O: "x" refers to the byte being read or written (byte a, b, c, d). |
| 86 | G | Input | Asynchronous Output Enable Input: Low — enables output buffers (DQx pins). High — DQx pins are high impedance. |
| 89 | K | Input | Clock: This signal registers the address, data in, and all control signals except G and LBO. |
| 31 | LBO | Input | Linear Burst Order Input: This pin must remain in steady state (this signal not registered or latched). It must be tied high or low. Low — linear burst counter (68K/PowerPC). High — interleaved burst counter (486/i960/Pentium). |
| 32, 33, 34, 35, 44, 45, 46, 47, 48, 49, 50, 81, 82, 99, 100 | SA | Input | Synchronous Address Inputs: These inputs are registered and must meet setup and hold times. |
| 36, 37 | SA1, SA0 | Input | Synchronous Address Inputs: these pins must be wired to the two LSBs of the address bus for proper burst operation. These inputs are registered and must meet setup and hold times. |
| 93, 94, 95, 96 (a) (b) (c) (d) | SBx | Input | Synchronous Byte Write Inputs: "x" refers to the byte being written (byte a, b, c, d). SGW overrides SBx. |
| 98 | SE1 | Input | Synchronous Chip Enable: Active low to enable chip. _____ Negated high — blocks ADSP or deselects chip when ADSC is asserted. |
| 97 | SE2 | Input | Synchronous Chip Enable: Active high for depth expansion. |
| 92 | SE3 | Input | Synchronous Chip Enable: Active low for depth expansion. |
| 88 | SGW | Input | Synchronous Global Write: This signal writes all bytes regardless of the status of the SBx and SW signals. If only byte write signals SBx are being used, tie this pin high. |
| 87 | SW | Input | Synchronous Write: This signal writes only those bytes that have been selected using the byte write SBx pins. If only byte write signals SBx are being used, tie this pin low. |
| 15, 41, 65, 91 | V _{DD} | Supply | Core Power Supply. |
| 4, 11, 20, 27, 54, 61, 70, 77 | V _{DDQ} | Supply | I/O Power Supply. |
| 5, 10, 17, 21, 26, 40, 55, 60, 67, 71, 76, 90 | V _{SS} | Supply | Ground. |
| 14, 16, 38, 39, 42, 43, 64, 66 | NC | — | No Connection: There is no connection to the chip. |

TRUTH TABLE (See Notes 1 Through 5)

| Next Cycle | Address Used | $\overline{SE1}$ | SE2 | $\overline{SE3}$ | \overline{ADSP} | \overline{ADSC} | \overline{ADV} | \overline{G}^3 | DQx | Write 2, 4 |
|----------------|--------------|------------------|-----|------------------|-------------------|-------------------|------------------|------------------|--------|-------------------|
| Deselect | None | 1 | X | X | X | 0 | X | X | High-Z | X |
| Deselect | None | 0 | X | 1 | 0 | X | X | X | High-Z | X |
| Deselect | None | 0 | 0 | X | 0 | X | X | X | High-Z | X |
| Deselect | None | X | X | 1 | 1 | 0 | X | X | High-Z | X |
| Deselect | None | X | 0 | X | 1 | 0 | X | X | High-Z | X |
| Begin Read | External | 0 | 1 | 0 | 0 | X | X | X | High-Z | X ⁵ |
| Begin Read | External | 0 | 1 | 0 | 1 | 0 | X | X | High-Z | READ ⁵ |
| Continue Read | Next | X | X | X | 1 | 1 | 0 | 1 | High-Z | READ |
| Continue Read | Next | X | X | X | 1 | 1 | 0 | 0 | DQ | READ |
| Continue Read | Next | 1 | X | X | X | 1 | 0 | 1 | High-Z | READ |
| Continue Read | Next | 1 | X | X | X | 1 | 0 | 0 | DQ | READ |
| Suspend Read | Current | X | X | X | 1 | 1 | 1 | 1 | High-Z | READ |
| Suspend Read | Current | X | X | X | 1 | 1 | 1 | 0 | DQ | READ |
| Suspend Read | Current | 1 | X | X | X | 1 | 1 | 1 | High-Z | READ |
| Suspend Read | Current | 1 | X | X | X | 1 | 1 | 0 | DQ | READ |
| Begin Write | External | 0 | 1 | 0 | 1 | 0 | X | X | High-Z | WRITE |
| Continue Write | Next | X | X | X | 1 | 1 | 0 | X | High-Z | WRITE |
| Continue Write | Next | 1 | X | X | X | 1 | 0 | X | High-Z | WRITE |
| Suspend Write | Current | X | X | X | 1 | 1 | 1 | X | High-Z | WRITE |
| Suspend Write | Current | 1 | X | X | X | 1 | 1 | X | High-Z | WRITE |

NOTES:

1. X = Don't Care. 1 = logic high. 0 = logic low.
2. \overline{W} rite is defined as either 1) any SBx and SW low or 2) SGW is low.
3. G is an asynchronous signal and is not sampled by the clock K. G drives the bus immediately (t_{GLQX}) following \overline{G} going low.
4. On write cycles that follow read cycles, G must be negated prior to the start of the write cycle to ensure proper write data setup times. G must also remain negated at the completion of the write cycle to ensure proper write data hold times.
5. This read assumes the RAM was previously deselected.

LINEAR BURST ADDRESS TABLE ($\overline{LBO} = V_{SS}$)

| 1st Address (External) | 2nd Address (Internal) | 3rd Address (Internal) | 4th Address (Internal) |
|------------------------|------------------------|------------------------|------------------------|
| X ... X00 | X ... X01 | X ... X10 | X ... X11 |
| X ... X01 | X ... X10 | X ... X11 | X ... X00 |
| X ... X10 | X ... X11 | X ... X00 | X ... X01 |
| X ... X11 | X ... X00 | X ... X01 | X ... X10 |

INTERLEAVED BURST ADDRESS TABLE ($\overline{LBO} = V_{DD}$)

| 1st Address (External) | 2nd Address (Internal) | 3rd Address (Internal) | 4th Address (Internal) |
|------------------------|------------------------|------------------------|------------------------|
| X ... X00 | X ... X01 | X ... X10 | X ... X11 |
| X ... X01 | X ... X00 | X ... X11 | X ... X10 |
| X ... X10 | X ... X11 | X ... X00 | X ... X01 |
| X ... X11 | X ... X10 | X ... X01 | X ... X00 |

WRITE TRUTH TABLE

| Cycle Type | SGW | SW | SBa | SBb | SBc | SBd |
|-----------------|-----|----|-----|-----|-----|-----|
| Read | H | H | X | X | X | X |
| Read | H | L | H | H | H | H |
| Write Byte a | H | L | L | H | H | H |
| Write Byte b | H | L | H | L | H | H |
| Write Byte c | H | L | H | H | L | H |
| Write Byte d | H | L | H | H | H | L |
| Write All Bytes | H | L | L | L | L | L |
| Write All Bytes | L | X | X | X | X | X |

ABSOLUTE MAXIMUM RATINGS (See Note 1)

| Rating | Symbol | Value | Unit | Notes |
|--|------------------------------------|---|------|-------|
| Power Supply Voltage | V _{DD} | V _{SS} – 0.5 to + 4.6 | V | |
| I/O Supply Voltage | V _{DDQ} | V _{SS} – 0.5 to V _{DD} | V | 2 |
| Input Voltage Relative to V _{SS} for Any Pin Except V _{DD} | V _{in} , V _{out} | V _{SS} – 0.5 to V _{DD} + 0.5 | V | 2 |
| Input Voltage (Three–State I/O) | V _{IT} | V _{SS} – 0.5 to V _{DDQ} + 0.5 | V | 2 |
| Output Current (per I/O) | I _{out} | ± 20 | mA | |
| Package Power Dissipation | P _D | 1.6 | W | 3 |
| Ambient Temperature | T _A | 0 to 70 | °C | |
| Die Temperature | T _J | 110 | °C | 3 |
| Temperature Under Bias | T _{bias} | – 10 to 85 | °C | |
| Storage Temperature | T _{stg} | – 55 to 125 | °C | |

This device contains circuitry to protect the inputs against damage due to high static voltages or electric fields; however, it is advised that normal precautions be taken to avoid application of any voltage higher than maximum rated voltages to this high–impedance circuit.

NOTES:

1. Permanent device damage may occur if ABSOLUTE MAXIMUM RATINGS are exceeded. Functional operation should be restricted to RECOMMENDED OPERATING CONDITIONS. Exposure to higher than recommended voltages for extended periods of time could affect device reliability.
2. This is a steady–state DC parameter that is in effect after the power supply has achieved its nominal operating level. Power sequencing is not necessary.
3. Power dissipation capability is dependent upon package characteristics and use environment. See Package Thermal Characteristics.

PACKAGE THERMAL CHARACTERISTICS — PBGA

| Rating | Symbol | Max | Unit | Notes |
|---------------------------------|------------------|----------|------|-------|
| Junction to Ambient (@ 200 lfm) | R _{θJA} | 38 22 | °C/W | 1, 2 |
| Junction to Board (Bottom) | R _{θJB} | 14 | °C/W | 3 |
| Junction to Case (Top) | R _{θJC} | 5 | °C/W | 4 |

NOTES:

1. Junction temperature is a function of on–chip power dissipation, package thermal resistance, mounting site (board) temperature, ambient temperature, air flow, board population, and board thermal resistance.
2. Per SEMI G38–87.
3. Indicates the average thermal resistance between the die and the printed circuit board.
4. Indicates the average thermal resistance between the die and the case top surface via the cold plate method (MIL SPEC–883 Method 1012.1).

PACKAGE THERMAL CHARACTERISTICS — TQFP

| Rating | Symbol | Max | Unit | Notes |
|---------------------------------|------------------|----------|------|-------|
| Junction to Ambient (@ 200 lfm) | R _{θJA} | 40 25 | °C/W | 1, 2 |
| Junction to Board (Bottom) | R _{θJB} | 17 | °C/W | 3 |
| Junction to Case (Top) | R _{θJC} | 9 | °C/W | 4 |

NOTES:

1. Junction temperature is a function of on–chip power dissipation, package thermal resistance, mounting site (board) temperature, ambient temperature, air flow, board population, and board thermal resistance.
2. Per SEMI G38–87.
3. Indicates the average thermal resistance between the die and the printed circuit board.
4. Indicates the average thermal resistance between the die and the case top surface via the cold plate method (MIL SPEC–883 Method 1012.1).

DC OPERATING CONDITIONS AND CHARACTERISTICS
 ($V_{DD} = 3.3\text{ V} + 10\%, -5\%$, $T_A = 0\text{ to }70^\circ\text{C}$, Unless Otherwise Noted)

RECOMMENDED OPERATING CONDITIONS: 2.5 V I/O Supply (Voltages Referenced to $V_{SS} = 0\text{ V}$)

| Parameter | Symbol | Min | Typ | Max | Unit |
|-------------------------------|-----------|-------|-----|-----------------|------|
| Supply Voltage | V_{DD} | 3.135 | 3.3 | 3.6 | V |
| I/O Supply Voltage | V_{DDQ} | 2.375 | 2.5 | 2.9 | V |
| Input Low Voltage | V_{IL} | -0.3 | — | 0.7 | V |
| Input High Voltage | V_{IH} | 1.7 | — | $V_{DD} + 0.3$ | V |
| Input High Voltage (I/O Pins) | V_{IH2} | 1.7 | — | $V_{DDQ} + 0.3$ | V |

RECOMMENDED OPERATING CONDITIONS: 3.3 V I/O Supply (Voltages Referenced to $V_{SS} = 0\text{ V}$)

| Parameter | Symbol | Min | Typ | Max | Unit |
|-------------------------------|-----------|-------|-----|-----------------|------|
| Supply Voltage | V_{DD} | 3.135 | 3.3 | 3.6 | V |
| I/O Supply Voltage | V_{DDQ} | 3.135 | 3.3 | V_{DD} | V |
| Input Low Voltage | V_{IL} | -0.5 | — | 0.8 | V |
| Input High Voltage | V_{IH} | 2 | — | $V_{DD} + 0.5$ | V |
| Input High Voltage (I/O Pins) | V_{IH2} | 2 | — | $V_{DDQ} + 0.5$ | V |

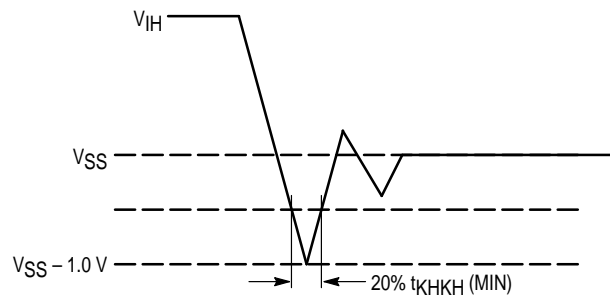

Figure 1. Undershoot Voltage

DC CHARACTERISTICS AND SUPPLY CURRENTS

| Parameter | Symbol | Min | Typ | Max | Unit | Notes |
|---|--------------|-----|-----|-------------------|---------------|---------|
| Input Leakage Current ($0 \text{ V} \leq V_{in} \leq V_{DD}$) | $I_{lkg(I)}$ | — | — | ± 1 | μA | |
| Output Leakage Current ($0 \text{ V} \leq V_{in} \leq V_{DDQ}$) | $I_{lkg(O)}$ | — | — | ± 1 | μA | |
| AC Supply Current (Device Selected, All Outputs Open, Freq = Max) Includes V_{DD} Only | I_{DDA} | — | — | 425 400 375 | mA | 1, 2, 3 |
| CMOS Standby Supply Current (Device Deselected, Freq = 0, $V_{DD} = \text{Max}$, All Inputs Static at CMOS Levels) | I_{SB2} | — | — | 45 | mA | 4, 5 |
| TTL Standby Supply Current (Device Deselected, Freq = 0, $V_{DD} = \text{Max}$, All Inputs Static at TTL Levels) | I_{SB3} | — | — | 50 | mA | 4, 6 |
| Clock Running (Device Deselected, Freq = Max, $V_{DD} = \text{Max}$, All Inputs Toggling at CMOS Levels) | I_{SB4} | — | — | 190 180 165 | mA | 4, 5 |
| Static Clock Running (Device Deselected, Freq = Max, $V_{DD} = \text{Max}$, All Inputs Static at TTL Levels) | I_{SB5} | — | — | 95 | mA | 4, 6 |
| Output Low Voltage ($I_{OL} = 2 \text{ mA}$) $V_{DDQ} = 2.5 \text{ V}$ | V_{OL} | — | — | 0.7 | V | |
| Output High Voltage ($I_{OL} = -2 \text{ mA}$) $V_{DDQ} = 2.5 \text{ V}$ | V_{OH} | 1.7 | — | — | V | |
| Output Low Voltage ($I_{OL} = 8 \text{ mA}$) $V_{DDQ} = 3.3 \text{ V}$ | V_{OL2} | — | — | 0.4 | V | |
| Output High Voltage ($I_{OL} = -4 \text{ mA}$) $V_{DDQ} = 3.3 \text{ V}$ | V_{OH2} | 2.4 | — | — | V | |

NOTES:

- Reference AC Operating Conditions and Characteristics for input and timing.
- All addresses transition simultaneously low (LSB) then high (MSB).
- Data states are all zero.
- Device is deselected as defined by the Truth Table.
- CMOS levels for I/O's are $V_{IT} \leq V_{SS} + 0.2 \text{ V}$ or $\geq V_{DDQ} - 0.2 \text{ V}$. CMOS levels for other inputs are $V_{in} \leq V_{SS} + 0.2 \text{ V}$ or $\geq V_{DD} - 0.2 \text{ V}$.
- TTL levels for I/O's are $V_{IT} \leq V_{IL}$ or $\geq V_{IH2}$. TTL levels for other inputs are $V_{in} \leq V_{IL}$ or $\geq V_{IH}$.

CAPACITANCE (f = 1.0 MHz, dV = 3.0 V, $T_A = 0$ to 70°C , Periodically Sampled Rather Than 100% Tested)

| Parameter | Symbol | Min | Typ | Max | Unit |
|--------------------------|-----------|-----|-----|-----|------|
| Input Capacitance | C_{in} | — | 4 | 5 | pF |
| Input/Output Capacitance | $C_{I/O}$ | — | 7 | 8 | pF |

AC OPERATING CONDITIONS AND CHARACTERISTICS

(V_{DD} = 3.3 v + 10%, - 5%, T_A = 0 to 70°C, Unless Otherwise Noted)

Input Timing Measurement Reference Level 1.25 V
 Input Pulse Levels 0 to 2.5 V
 Input Rise/Fall Times 1.0 V/ns (20 to 80%)

Output Timing Reference Level 1.25 V
 Output Load See Figure 2 Unless Otherwise Noted

READ/WRITE CYCLE TIMING (See Notes 1 and 2)

| Parameter | Symbol | MCM69P737-3.5 166 MHz | | MCM69P737-3.8 150 MHz | | MCM69P737-4 133 MHz | | Unit | Notes |
|---|---|--------------------------|-----|--------------------------|-----|------------------------|-----|------|-------|
| | | Min | Max | Min | Max | Min | Max | | |
| Cycle Time | t _{KHKH} | 6 | — | 6.7 | — | 7.5 | — | ns | |
| Clock High Pulse Width | t _{KHKL} | 2.4 | — | 2.6 | — | 3 | — | ns | 3 |
| Clock Low Pulse Width | t _{KLKH} | 2.4 | — | 2.6 | — | 3 | — | ns | 3 |
| Clock Access Time | t _{KHQV} | — | 3.5 | — | 3.8 | — | 4 | ns | |
| Output Enable to Output Valid | t _{GLQV} | — | 3.5 | — | 3.5 | — | 3.8 | ns | |
| Clock High to Output Active | t _{KHQX1} | 0 | — | 0 | — | 0 | — | ns | 4, 5 |
| Clock High to Output Change | t _{KHQX2} | 1.5 | — | 1.5 | — | 1.5 | — | ns | 4 |
| Output Enable to Output Active | t _{GLQX} | 0 | — | 0 | — | 0 | — | ns | 4, 5 |
| Output Disable to Q High-Z | t _{GHQZ} | — | 3.5 | — | 3.5 | — | 3.8 | ns | 4, 5 |
| Clock High to Q High-Z | t _{KHQZ} | 1.5 | 6 | 1.5 | 6.7 | 1.5 | 7.5 | ns | 4, 5 |
| Setup Times: _____ Address ADSP, ADSC, ADV _____ Data In _____ Write _____ Chip Enable | t _{ADKH} t _{ADSKH} t _{DVKH} t _{WVKH} t _{EVKH} | 1.5 | — | 1.5 | — | 1.5 | — | ns | |
| Hold Times: _____ Address ADSP, ADSC, ADV _____ Data In _____ Write _____ Chip Enable | t _{KHAX} t _{KHADSX} t _{KHDX} t _{KHWX} t _{KHEX} | 0.5 | — | 0.5 | — | 0.5 | — | ns | |

NOTES:

1. Write is defined as either any \overline{SBx} and \overline{SW} low or \overline{SGW} is low. Chip Enable is defined as $\overline{SE1}$ low, $\overline{SE2}$ high, and $\overline{SE3}$ low whenever \overline{ADSP} or \overline{ADSC} is asserted.
2. All read and write cycle timings are referenced from K or G.
3. In order to reduce test correlation issues and to reduce the effects of application specific input edge rate variations on correlation between data sheet parameters and actual system performance, FSRAM AC parametric specifications are always specified at V_{DDQ}/2. In some design exercises, it is desirable to evaluate timing using other reference levels. Since the maximum test input edge rate is known and is given in the AC Test Conditions section of the data sheet as 1 V/ns, one can easily interpolate timing values to other reference levels.
4. This parameter is sampled and not 100% tested.
5. Measured at ± 200 mV from steady state.

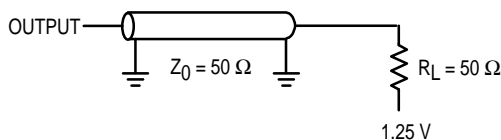

Figure 2. AC Test Load

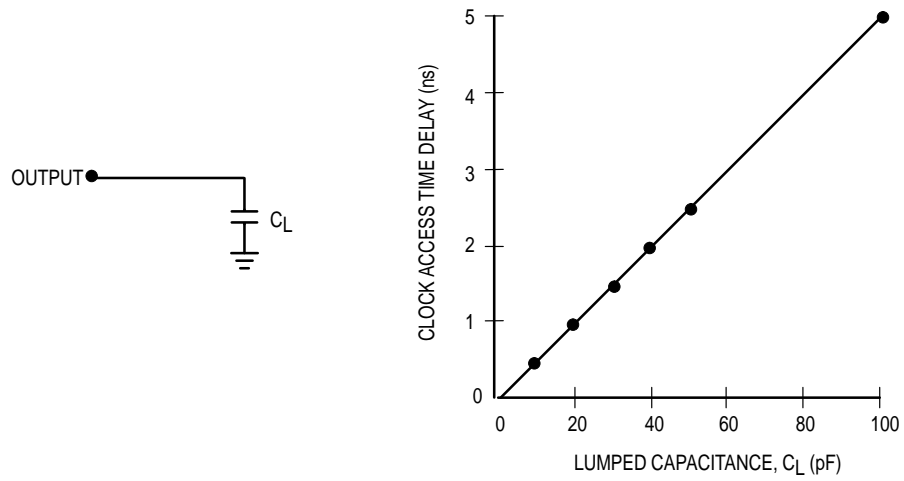

Figure 3. Lumped Capacitive Load and Typical Derating Curve

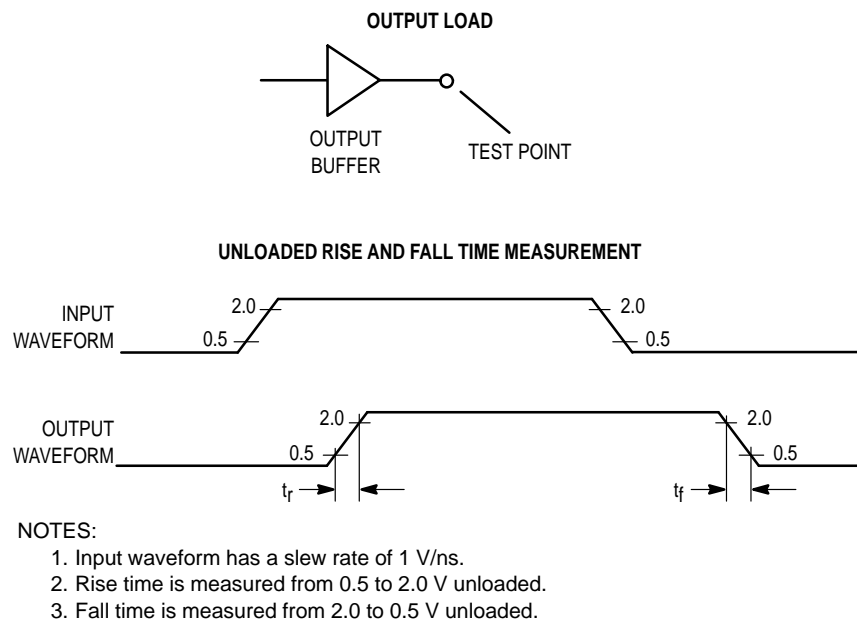
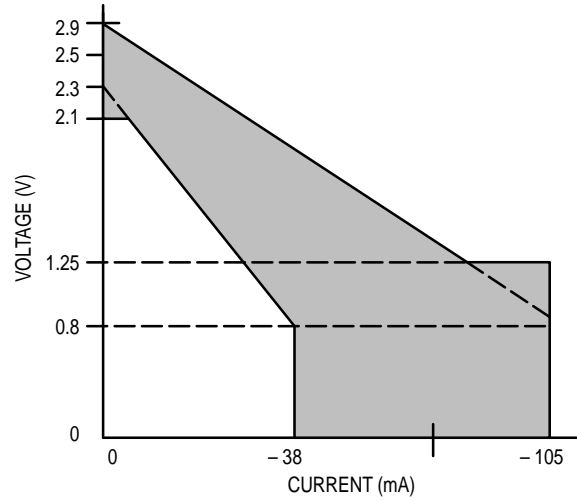

Figure 4. Unloaded Rise and Fall Time Characterization

| PULL-UP | | |
|-------------|------------|------------|
| VOLTAGE (V) | I (mA) MIN | I (mA) MAX |
| -0.5 | -38 | -105 |
| 0 | -38 | -105 |
| 0.8 | -38 | -105 |
| 1.25 | -26 | -83 |
| 1.5 | -20 | -70 |
| 2.3 | 0 | -30 |
| 2.7 | 0 | -10 |
| 2.9 | 0 | 0 |



(a) Pull-Up for 2.5 V I/O Supply

| PULL-UP | | |
|-------------|------------|------------|
| VOLTAGE (V) | I (mA) MIN | I (mA) MAX |
| -0.5 | -50 | -150 |
| 0 | -50 | -150 |
| 1.4 | -50 | -150 |
| 1.65 | -46 | -130 |
| 2.0 | -35 | -101 |
| 3.135 | 0 | -25 |
| 3.6 | 0 | 0 |

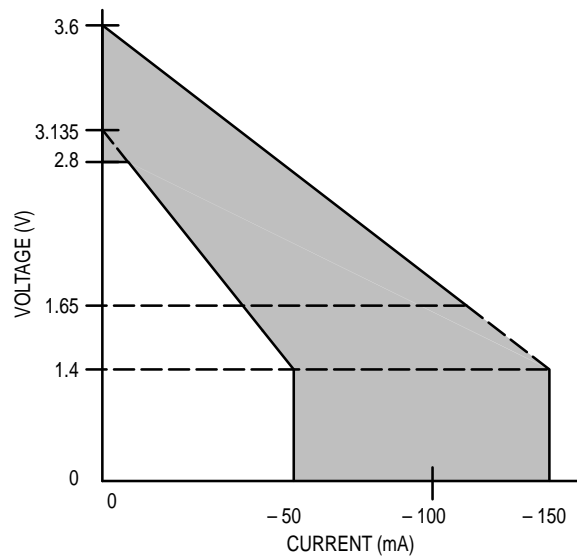

(b) Pull-Up for 3.3 V I/O Supply

| PULL-DOWN | | |
|-------------|------------|------------|
| VOLTAGE (V) | I (mA) MIN | I (mA) MAX |
| -0.5 | 0 | 0 |
| 0 | 0 | 0 |
| 0.4 | 10 | 20 |
| 0.8 | 20 | 40 |
| 1.25 | 31 | 63 |
| 1.6 | 40 | 80 |
| 2.8 | 40 | 80 |
| 3.2 | 40 | 80 |
| 3.4 | 40 | 80 |

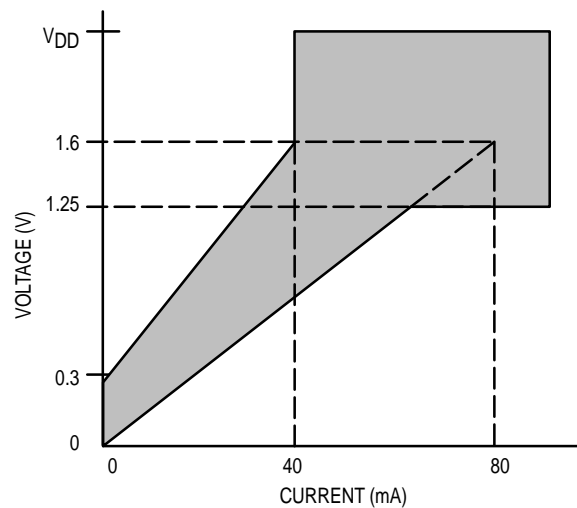

(c) Pull-Down

Figure 5. Typical Output Buffer Characteristics

READWRITE CYCLES

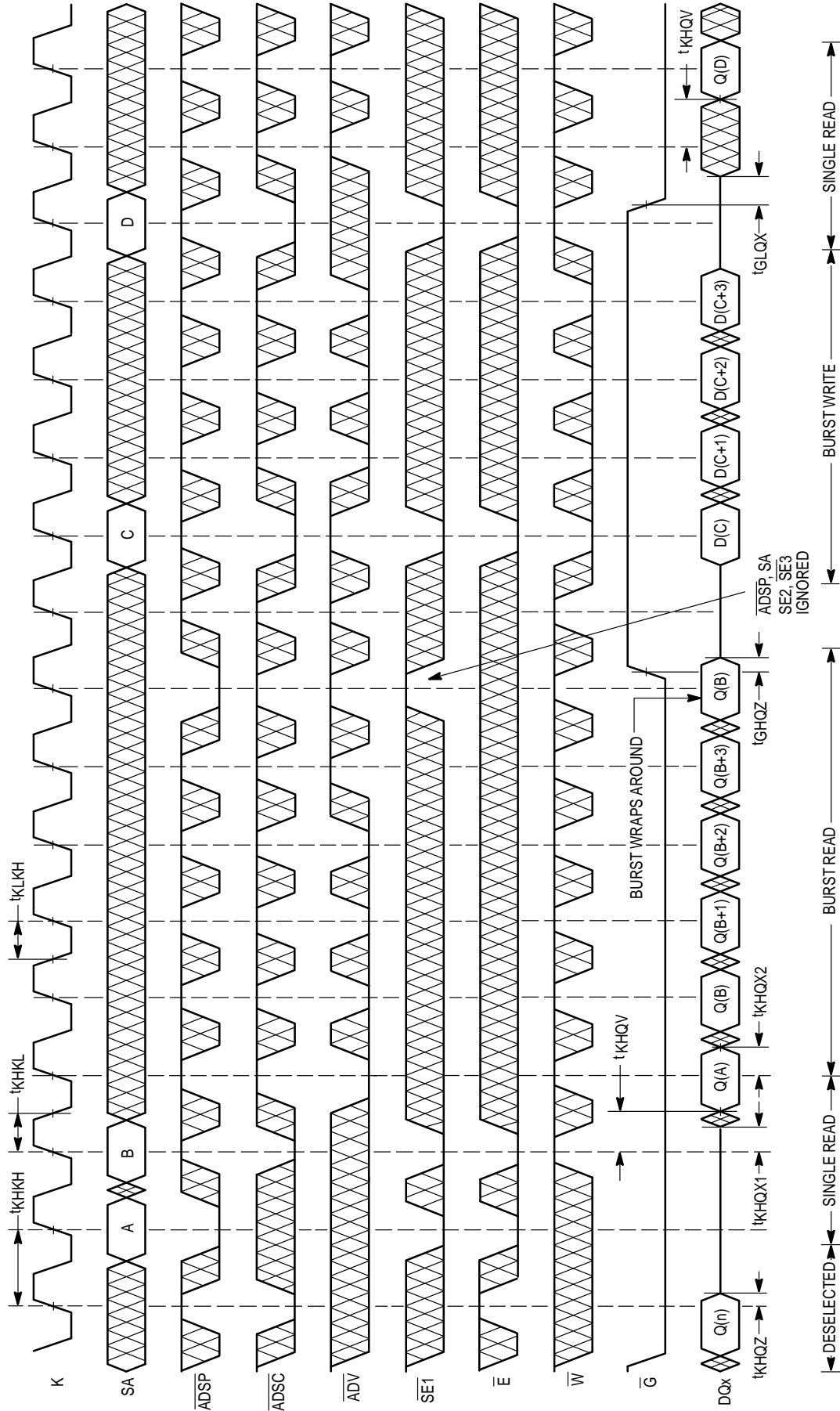

NOTE: \bar{E} low = SE2 high and $\bar{SE3}$ low.
 \bar{W} low = SGW low and/or SW and \bar{SBx} low.

APPLICATION INFORMATION

STOP CLOCK OPERATION

In the stop clock mode of operation, the SRAM will hold all state and data values even though the clock is not running (full static operation). The SRAM design allows the clock to start with ADSP and ADSC, and stops the clock after the last write data is latched, or the last read data is driven out.

When starting and stopping the clock, the AC clock timing and parametrics must be strictly maintained. For example,

clock pulse width and edge rates must be guaranteed when starting and stopping the clocks.

To achieve the lowest power operation for all three stop clock modes, stop read, stop write, and stop deselect:

- Force the clock to a low state.
- Force the control signals to an inactive state (this guarantees any potential source of noise on the clock input will not start an unplanned on activity).
- Force the address inputs to a low state.

STOP CLOCK WITH READ TIMING

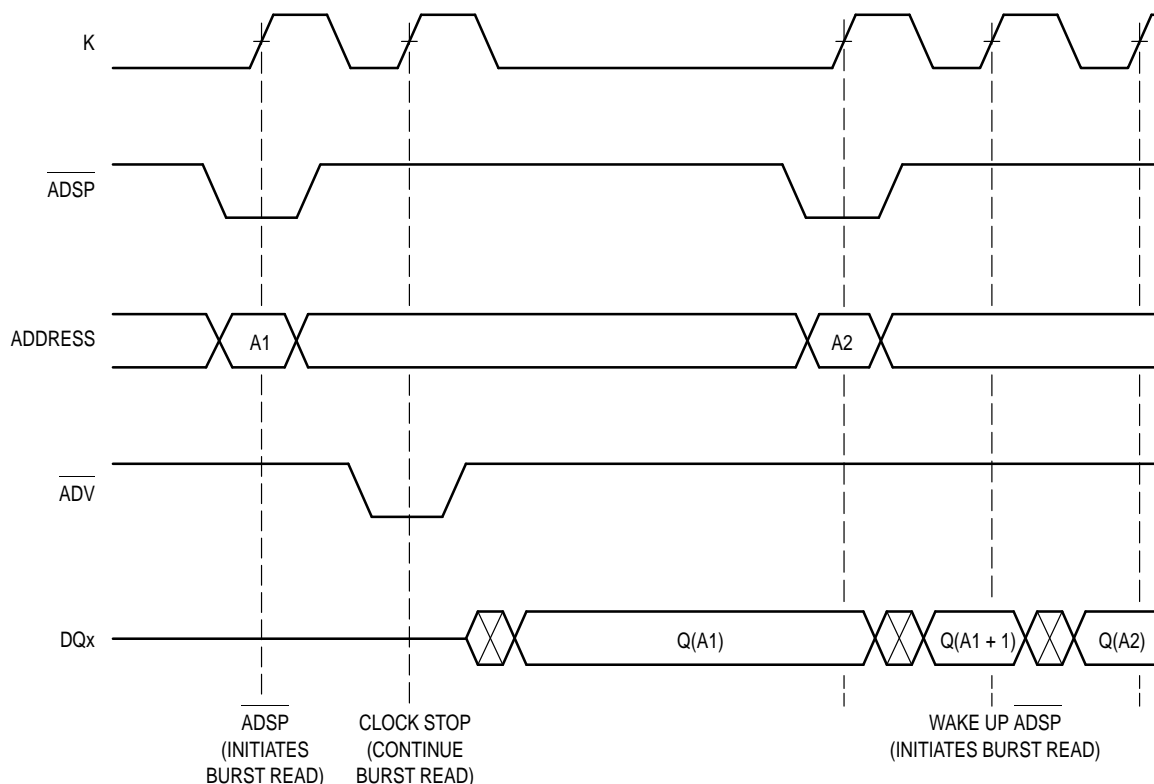

NOTE: For lowest possible power consumption during stop clock, the addresses should be driven to a low state (V_{IL}). Best results are obtained if $V_{IL} < 0.2$ V.

STOP CLOCK WITH WRITE TIMING

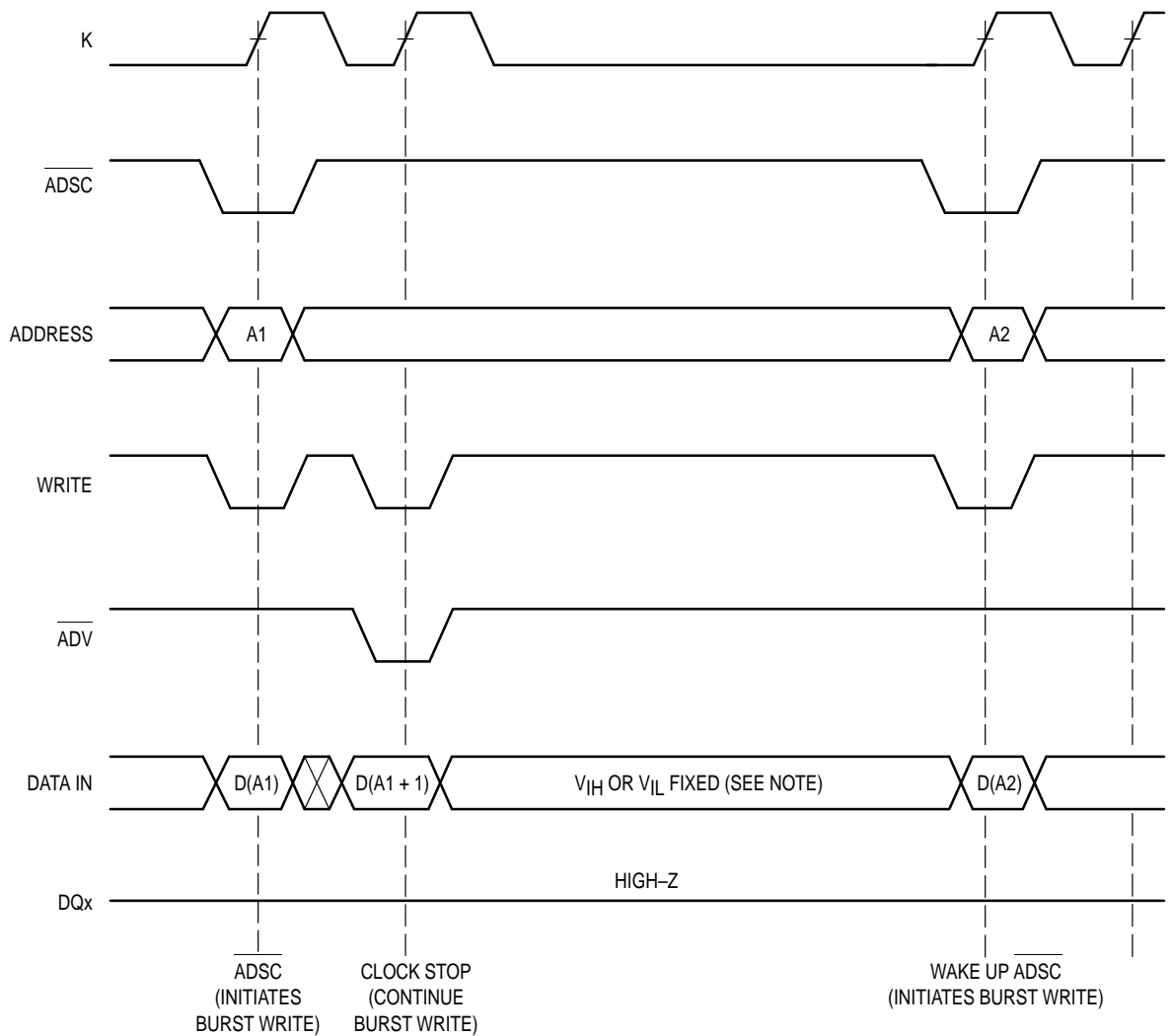

NOTE: While the clock is stopped, DATA IN must be fixed in a high (V_{IH}) or low (V_{IL}) state to reduce the DC current of the input buffers. For lowest power operation, all data and address lines should be held in a low (V_{IL}) state and control lines held in an inactive state.

STOP CLOCK WITH DESELECT OPERATION TIMING

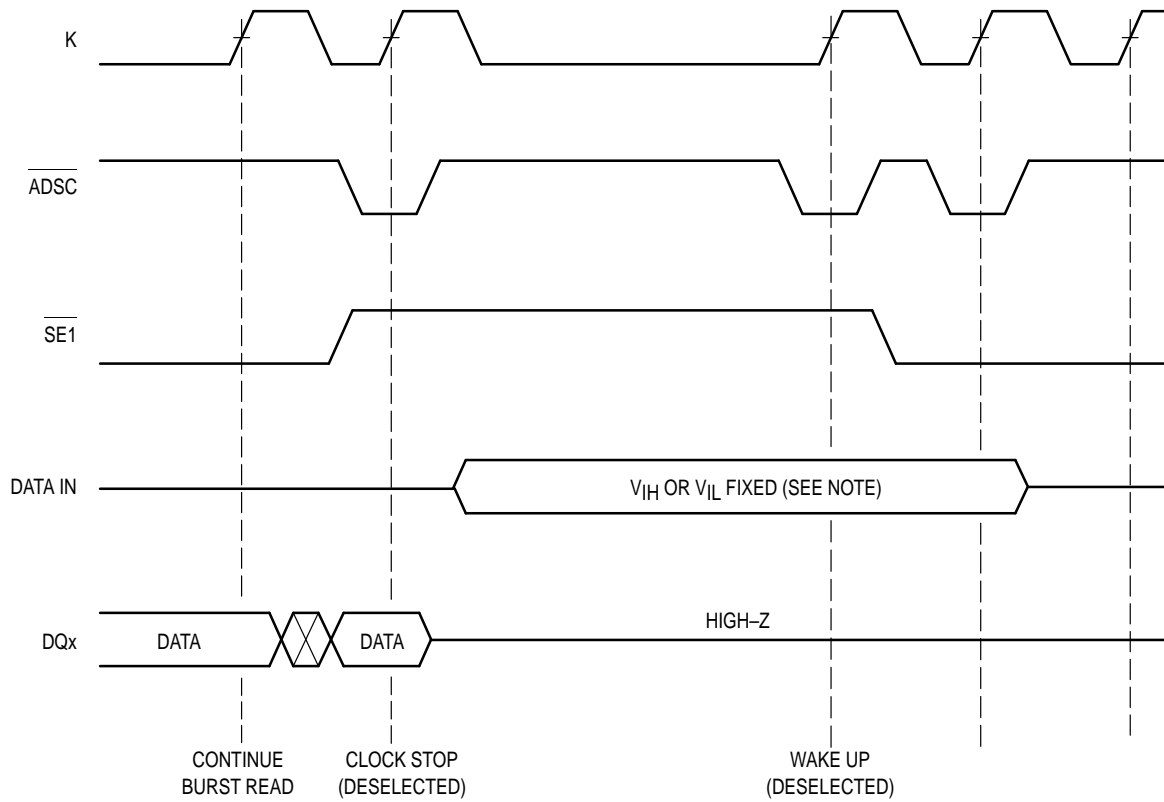

NOTE: While the clock is stopped, DATA IN must be fixed in a high (V_{IH}) or low (V_{IL}) state to reduce the DC current of the input buffers. For lowest power operation, all data and address lines should be held in a low (V_{IL}) state and control lines held in an inactive state.

NON-BURST SYNCHRONOUS OPERATION

Although this BurstRAM has been designed for PowerPC-based and other high end MPU-based systems, these SRAMs can be used in other high speed L2 cache or memory applications that do not require the burst address feature. Most L2 caches designed with a synchronous interface can make use of the MCM69P737. The burst counter feature of the BurstRAM can be disabled, and the SRAM can be configured to act upon a continuous stream of addresses. See Figure 6.

CONTROL PIN TIE VALUES EXAMPLE ($H \geq V_{IH}, L \leq V_{IL}$)

| Non-Burst | ADSP | ADSC | ADV | SE1 | SE2 | LBO |
|--------------------------------|------|------|-----|-----|-----|-----|
| Sync Non-Burst, Pipelined SRAM | H | L | H | L | H | X |

NOTE: Although X is specified in the table as a don't care, the pin must be tied either high or low.

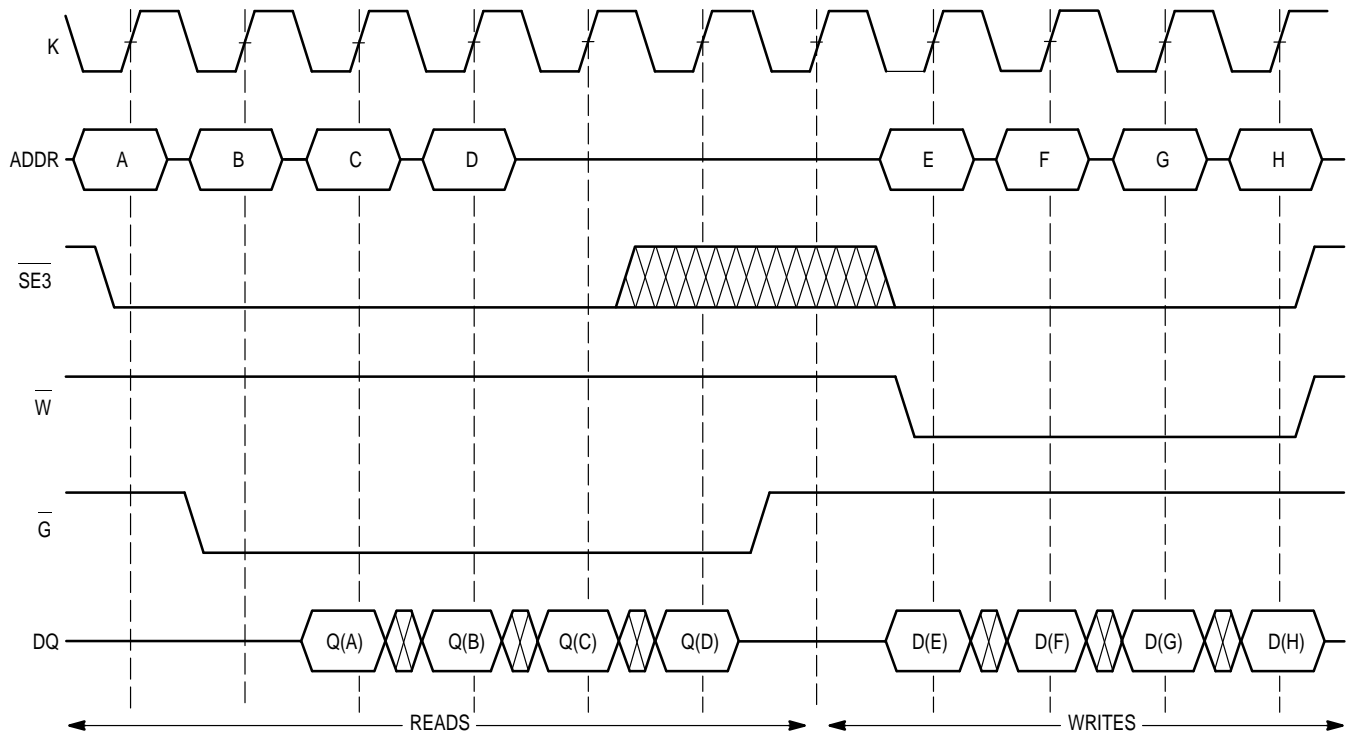

Figure 6. Example Configuration as Non-Burst Synchronous SRAM

ORDERING INFORMATION (Order by Full Part Number)

MCM **69P737** **XX** **X** **X**
 Motorola Memory Prefix —————
 Part Number —————
 Blank = Trays, R = Tape and Reel
 Speed (3.5 = 3.5 ns, 3.8 = 3.8 ns, 4 = 4 ns)
 Package (ZP = PBGA, TQ = TQFP)

Full Part Numbers — MCM69P737ZP3.5 MCM69P737ZP3.8 MCM69P737ZP4
 MCM69P737ZP3.5R MCM69P737ZP3.8R MCM69P737ZP4R
 MCM69P737TQ3.5 MCM69P737TQ3.8 MCM69P737TQ4
 MCM69P737TQ3.5R MCM69P737TQ3.8R MCM69P737TQ4R

PACKAGE DIMENSIONS

ZP PACKAGE 7 x 17 BUMP PBGA CASE 999-02

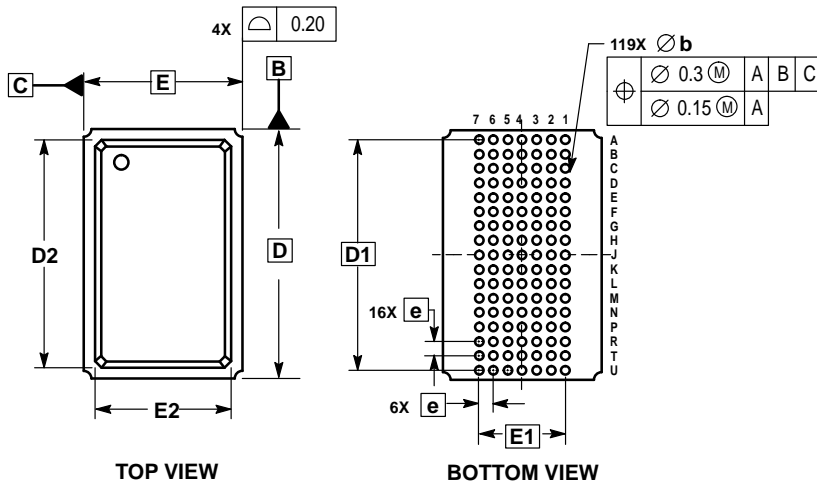

- NOTES:
1. DIMENSIONING AND TOLERANCING PER ASME Y14.5M, 1994.
 2. ALL DIMENSIONS IN MILLIMETERS.
 3. DIMENSION b IS THE MAXIMUM SOLDER BALL DIAMETER MEASURED PARALLEL TO DATUM A.
 4. DATUM A, THE SEATING PLANE, IS DEFINED BY THE SPHERICAL CROWNS OF THE SOLDER BALLS.

| DIM | MILLIMETERS | |
|-----|-------------|-------|
| | MIN | MAX |
| A | — | 2.40 |
| A1 | 0.50 | 0.70 |
| A2 | 1.30 | 1.70 |
| A3 | 0.80 | 1.00 |
| D | 22.00 BSC | |
| D1 | 20.32 BSC | |
| D2 | 19.40 | 19.60 |
| E | 14.00 BSC | |
| E1 | 7.62 BSC | |
| E2 | 11.90 | 12.10 |
| b | 0.60 | 0.90 |
| e | 1.27 BSC | |

Motorola reserves the right to make changes without further notice to any products herein. Motorola makes no warranty, representation or guarantee regarding the suitability of its products for any particular purpose, nor does Motorola assume any liability arising out of the application or use of any product or circuit, and specifically disclaims any and all liability, including without limitation consequential or incidental damages. "Typical" parameters which may be provided in Motorola data sheets and/or specifications can and do vary in different applications and actual performance may vary over time. All operating parameters, including "Typicals" must be validated for each customer application by customer's technical experts. Motorola does not convey any license under its patent rights nor the rights of others. Motorola products are not designed, intended, or authorized for use as components in systems intended for surgical implant into the body, or other applications intended to support or sustain life, or for any other application in which the failure of the Motorola product could create a situation where personal injury or death may occur. Should Buyer purchase or use Motorola products for any such unintended or unauthorized application, Buyer shall indemnify and hold Motorola and its officers, employees, subsidiaries, affiliates, and distributors harmless against all claims, costs, damages, and expenses, and reasonable attorney fees arising out of, directly or indirectly, any claim of personal injury or death associated with such unintended or unauthorized use, even if such claim alleges that Motorola was negligent regarding the design or manufacture of the part. Motorola and  are registered trademarks of Motorola, Inc. Motorola, Inc. is an Equal Opportunity/Affirmative Action Employer.

Mfax is a trademark of Motorola, Inc.

How to reach us:

USA/EUROPE/Locations Not Listed: Motorola Literature Distribution;
P.O. Box 5405, Denver, Colorado, 80217. 1-303-675-2140 or 1-800-441-2447

Mfax™: RMFAX0@email.sps.mot.com – TOUCHTONE 1-602-244-6609
Motorola Fax Back System – US & Canada ONLY 1-800-774-1848
– http://sps.motorola.com/mfax/

HOME PAGE: <http://motorola.com/sps/>

JAPAN: Nippon Motorola Ltd.: SPD, Strategic Planning Office, 141,
4-32-1 Nishi-Gotanda, Shagawa-ku, Tokyo, Japan. 03-5487-8488

ASIA/PACIFIC: Motorola Semiconductors H.K. Ltd.; 8B Tai Ping Industrial Park,
51 Ting Kok Road, Tai Po, N.T., Hong Kong. 852-26629298

CUSTOMER FOCUS CENTER: 1-800-521-6274



MOTOROLA



MCM69P737/D