

SI-3000F Series

5-Terminal, Multi-Function, Full-Mold, Low Dropout Voltage Dropper Type

■Features

- Compact full-mold package (equivalent to TO220)
- Output current: 1.0A
- Low dropout voltage: $V_{DIF} \leq 1V$ (at $I_o = 1.0A$)
- Variable output voltage (rise only)
May be used for remote sensing (excluding SI-3025F)
- Output ON/OFF control terminal is compatible with LS-TTL. (It may be directly driven by LS-TTL or standard CMOS logic.)
- Built-in foldback overcurrent, overvoltage, thermal protection circuits
- Variable output voltage type (SI-3025F) also available



■Applications

- For stabilization of the secondary stage of switching power supplies
- Electronic equipment

■Absolute Maximum Ratings

(T_a=25°C)

Parameter	Symbol	Ratings					Unit
		SI-3050F	SI-3090F/3120F	SI-3150F/3157F	SI-3240F	SI-3025F	
DC Input Voltage	V _{IN}	25	30	35	45	30	V
Voltage of Output Control Terminal	V _c	V _{IN}					V
DC Output Current	I _o	1.0 ²					A
Power Dissipation	P _{D1}	14(With infinite heatsink)					W
	P _{D2}	1.5(Without heatsink, stand-alone operation)					W
Junction Temperature	T _j	-40 to +125					°C
Ambient Operating Temperature	T _{op}	-30 to +100					°C
Storage Temperature	T _{stg}	-40 to +125					°C
Thermal Resistance (junction to case)	R _{th(j-c)}	7.0					°C/W
Thermal Resistance (junction to ambient air)	R _{th(j-a)}	66.7(Without heatsink, stand-alone operation)					°C/W

■Electrical Characteristics (excluding SI-3025F)

(Ta=25°C unless otherwise specified)

Parameter	Symbol	Ratings																		Unit
		SI-3050F			SI-3090F			SI-3120F			SI-3150F			SI-3157F			SI-3240F			
		min.	typ.	max.	min.	typ.	max.	min.	typ.	max.	min.	typ.	max.	min.	typ.	max.	min.	typ.	max.	
Input Voltage	V _{IN}	6 ³		15 ²	10 ³		20 ²	13 ³		25 ²	16 ³		27 ²	16.7 ³		27 ²	25 ³		40	V
Output Voltage	SI-3000F ^{*1}	4.80	5.00	5.20	8.64	9.00	9.36	11.52	12.00	12.48	14.40	15.00	15.60	14.92	15.70	16.48	23.04	24.00	24.96	V
	SI-3000FA	4.90	5.00	5.10	8.82	9.00	9.18	11.76	12.00	12.24	14.70	15.00	15.30							
Dropout Voltage	V _{DIF}			0.5			0.5			0.5			0.5			0.5			0.5	V
	Conditions	I _o ≤0.5A																		
	Conditions			1.0			1.0			1.0			1.0			1.0			1.0	
Line Regulation	ΔV _{OLINE}		10	30		18	48		24	64		30	90		30	90		48	128	mV
	Conditions	V _{IN} =6V to 15V, I _o =0.5A			V _{IN} =10V to 20V, I _o =0.5A			V _{IN} =13V to 25V, I _o =0.5A			V _{IN} =16V to 27V, I _o =0.5A			V _{IN} =17V to 27V, I _o =0.5A			V _{IN} =25V to 38V, I _o =0.5A			
Load Regulation	ΔV _{OLOAD}		40	100		70	180		93	240		120	300		120	300		120	300	mV
	Conditions	V _{IN} =8V, I _o =0 to 1.0A			V _{IN} =12V, I _o =0 to 1.0A			V _{IN} =15V, I _o =0 to 1.0A			V _{IN} =18V, I _o =0 to 1.0A			V _{IN} =19V, I _o =0 to 1.0A			V _{IN} =27V, I _o =0 to 1.0A			
Temperature Coefficient of Output Voltage	ΔV _O /ΔT _a		±0.5			±1.0			±1.5			±1.5			±1.5			±2.5		mV/°C
	Conditions	V _{IN} =8V, I _o =5mA, T _j =0 to 100°C			V _{IN} =12V, I _o =5mA, T _j =0 to 100°C			V _{IN} =15V, I _o =5mA, T _j =0 to 100°C			V _{IN} =18V, I _o =5mA, T _j =0 to 100°C			V _{IN} =19V, I _o =5mA, T _j =0 to 100°C			V _{IN} =27V, I _o =5mA, T _j =0 to 100°C			
Ripple Rejection	R _{REJ}		54			54			54			54			54			54		dB
	Conditions	V _{IN} =8V, f=100 to 120Hz			V _{IN} =12V, f=100 to 120Hz			V _{IN} =15V, f=100 to 120Hz			V _{IN} =18V, f=100 to 120Hz			V _{IN} =19V, f=100 to 120Hz			V _{IN} =27V, f=100 to 120Hz			
Quiescent Circuit Current	I _q		3	10		3	10		3	10		3	10		3	10		5	10	mA
	Conditions	V _{IN} =8V, I _o =0A			V _{IN} =12V, I _o =0A			V _{IN} =15V, I _o =0A			V _{IN} =18V, I _o =0A			V _{IN} =19V, I _o =0A			V _{IN} =27V, I _o =0A			
Overcurrent Protection Starting Current ^{*4,7}	I _{s1}	1.2			1.2			1.2			1.2			1.2			1.2			A
	Conditions	V _{IN} =8V			V _{IN} =12V			V _{IN} =15V			V _{IN} =18V			V _{IN} =19V			V _{IN} =27V			
V _c Terminal ^{*5}	Control Voltage (Output ON)	V _c . IH	2.0			2.0			2.0			2.0			2.0			2.0		V
	Control Voltage (Output OFF)	V _c . IL			0.8			0.8			0.8			0.8			0.8		0.8	
	Control Current (Output ON)	I _c . IH			20			20			20			20			20		20	μA
	Conditions	V _c =2.7V																		
Control Current (Output OFF)	I _c . IL			-0.3			-0.3			-0.3			-0.3			-0.3			-0.3	mA
	Conditions	V _c =0.4V																		

*1: "A" may be indicated to the right of the Sanken logo.

*2: V_{IN(max)} and I_{o(max)} are restricted by the relation P_{D(max)}=(V_{IN}-V_O)•I_o≤14(W).

*3: Refer to the dropout voltage.(Refer to Setting DC Input Voltage on page 7.)

*4: I_{s1} is specified at -5(%) drop point of output voltage V_O on the condition that V_{IN}=V_O+3V, I_o=0.5A.

*5: Output is ON even when output control terminal VC is open. Each input level is equivalent to LS-TTL. Therefore, it may be directly driven by an LS-TTL circuit.

*6: When setting output voltage to 5V or less, input voltage needs to be set to 6V or over to operate stably.

*7: A foldback type overcurrent protection circuit is built into the IC regulator. Therefore, avoid using it for the following applications as it may cause starting errors:

- (1) Constant current load (2) Plus/minus power (3) Series power (4) V_O adjustment by raising ground voltage

■Electrical Characteristics (SI-3025F)

(Ta=25°C unless otherwise specified)

Parameter	Symbol	Ratings			Unit	
		SI-3025F				
		min.	typ.	max.		
Input Voltage	V _{IN}	6 ⁶		25 ²	V	
Output Voltage	V _O	3		24	V	
Reference Voltage	V _{REF}	2.45	2.55	2.65	V	
Dropout Voltage	V _{DIF}			0.5	V	
	Conditions	I _O ≤0.5A				
	Conditions	I _O ≤1.0A				
Line Regulation	ΔV _{OLINE}			10	mV/V	
	Conditions	V _{IN} =V _O +1 to 25V, I _O =0.5A				
Load Regulation	ΔV _{OLOAD}			20	mV/V	
	Conditions	V _{IN} =V _O +3V, I _O =0 to 1.0A				
Temperature Coefficient of Reference Voltage	ΔV _{REF} /ΔT _a		±0.5		mV/°C	
	Conditions	V _{IN} =V _O +3V, I _O =5mA, T _J =0 to 100°C				
Ripple Rejection	R _{REJ}		54		dB	
	Conditions	V _{IN} =V _O +3V, f=100 to 120Hz				
Quiescent Circuit Current	I _q		3	10	mA	
	Conditions	V _{IN} =V _O +3V, I _O =0A				
Overcurrent Protection Starting Current ^{4,7}	I _{S1}	1.2			A	
	Conditions	V _{IN} =V _O +3V				
V _c Terminal ⁵	Control Voltage (Output ON)	V _c IH	2.0		V	
	Control Voltage (Output OFF)	V _c IL		0.8		
	Control Current (Output ON)	I _c IH			20	μA
		Conditions	V _c =2.7V			
	Control Current (Output OFF)	I _c IL			-0.3	mA
		Conditions	V _c =0.4V			

■Outline Drawing

(unit:mm)

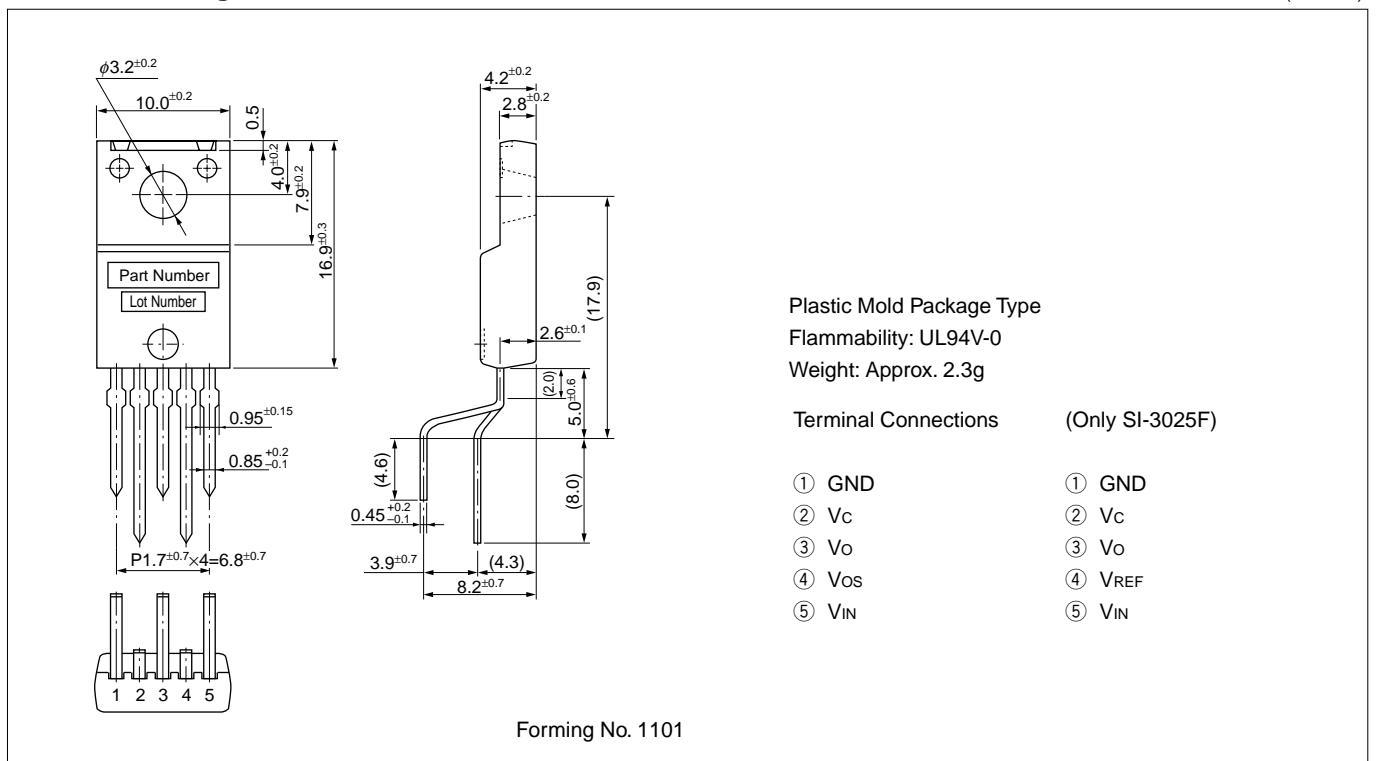

■Block Diagram

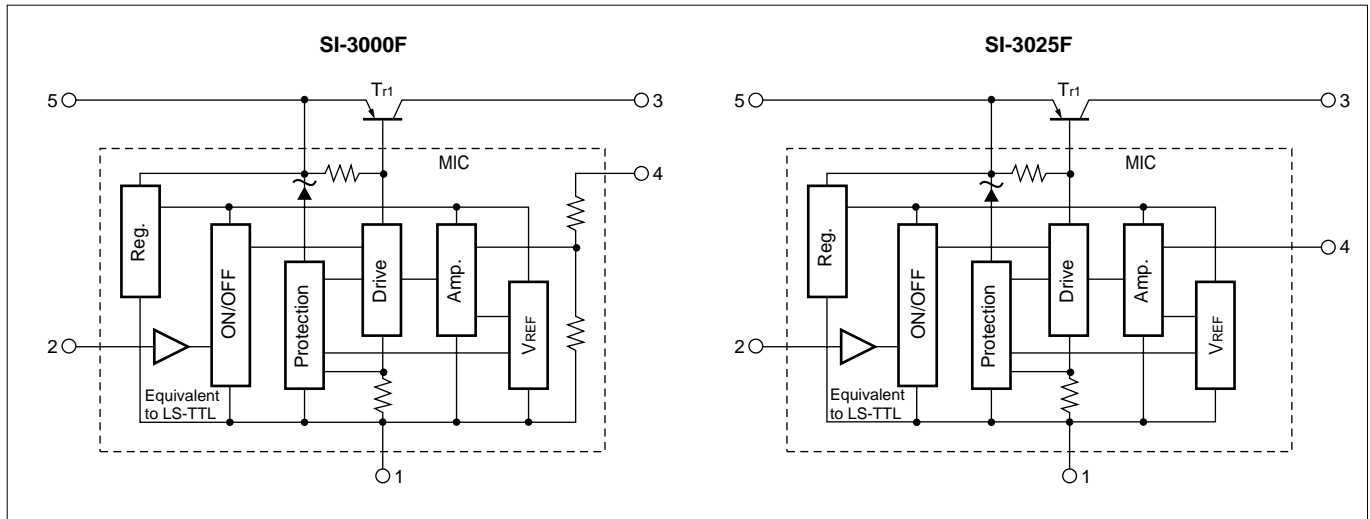

■Standard External Circuit

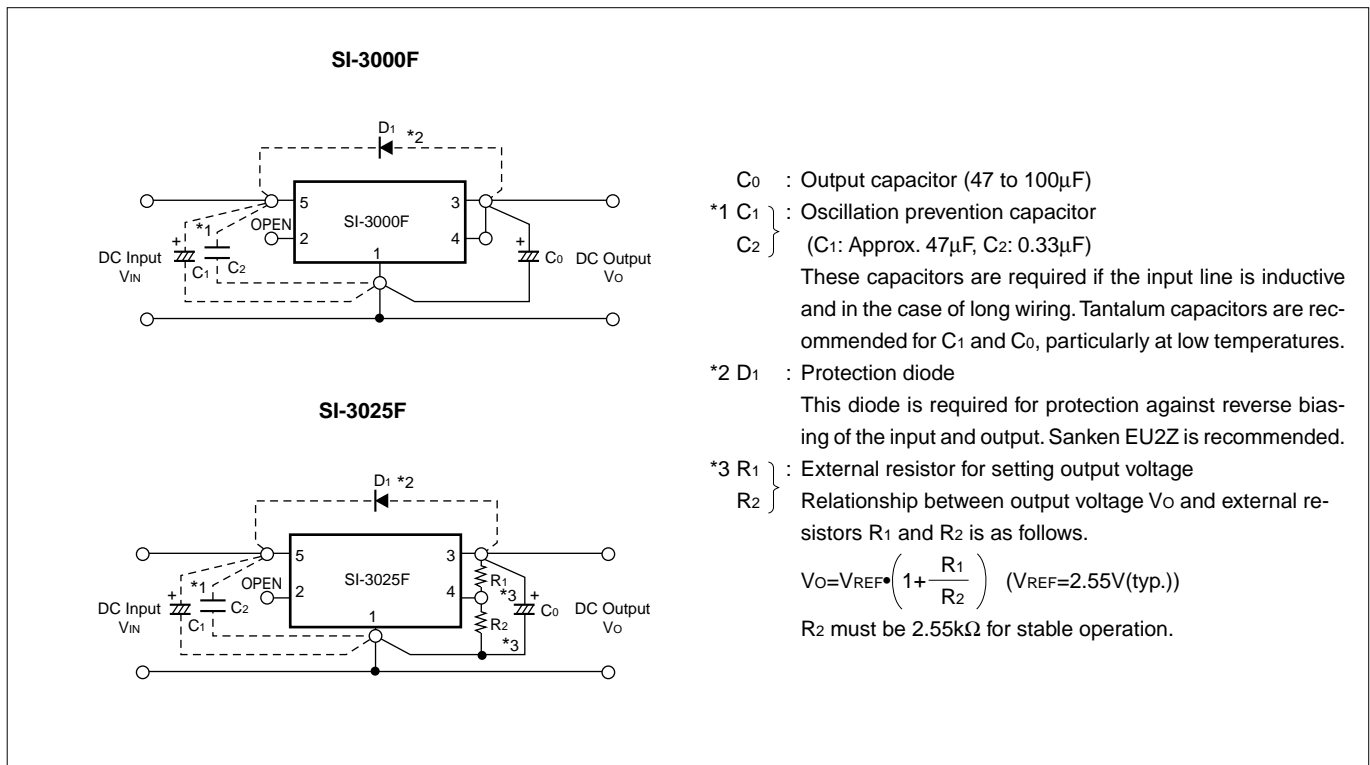

■ T_a - P_D Characteristics

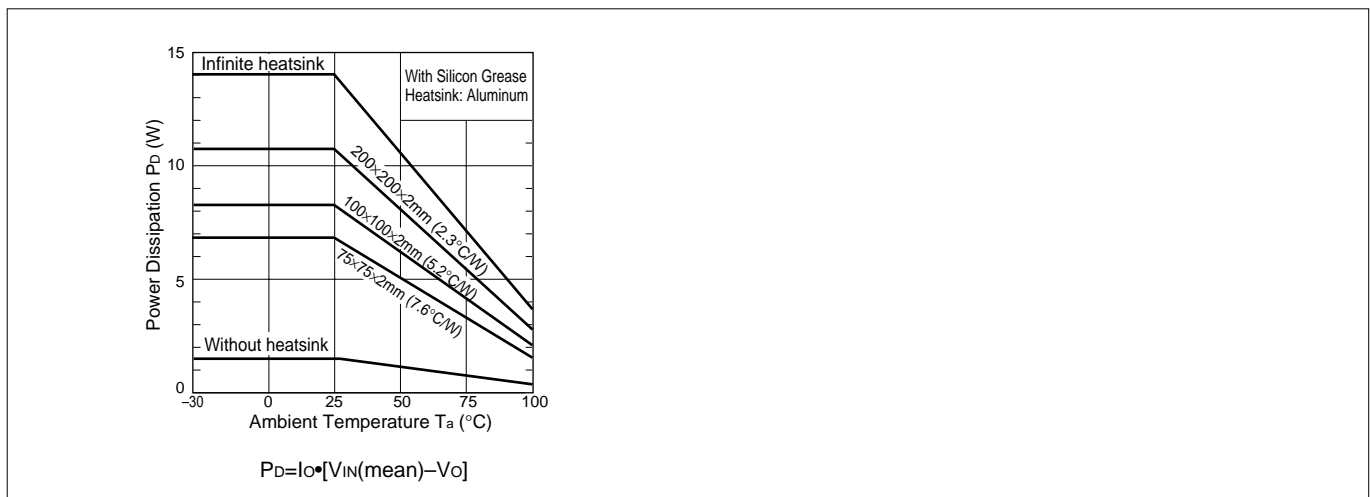

External Variable Output Voltage Circuit (Excluding SI-3025F)

1. Variable output voltage with a single external resistor

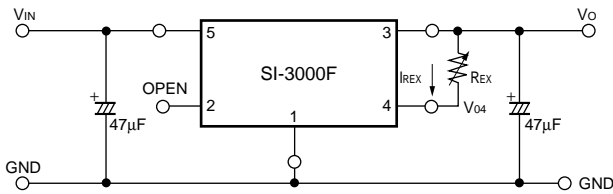

The output voltage may be increased by inserting resistor R_{EX} between terminals No.4 (sensing terminal) and No.3 (output terminal). The current I_{REX} flowing into terminal No.4 is 1mA (typ.), therefore the adjusted output voltage V_{OUT} is:

$$V_O = V_{04} + I_{REX} \cdot R_{EX} \quad *V_{04}: \text{output voltage of SI-3000F series}$$

However, the built-in resistor (between terminals No. 4 and No.1) is a semiconductor resistor, which has approximately thermal characteristics of $+0.2\%/^{\circ}\text{C}$.

It is important to keep the thermal characteristics in mind when adjusting the output voltage.

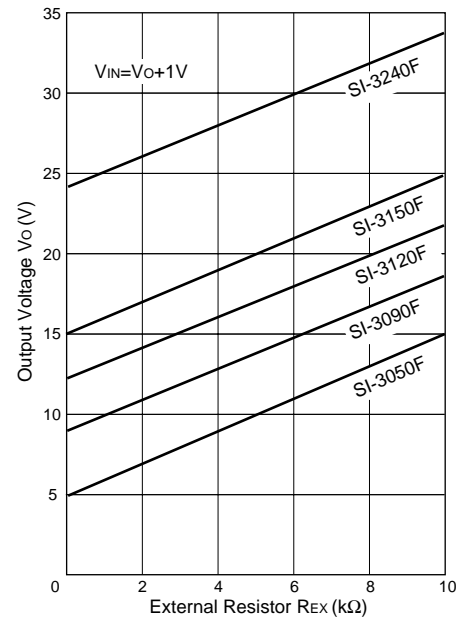

2. Variable output voltage with two external resistors

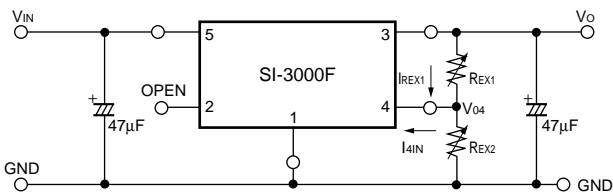

The output voltage may be increased by inserting resistors R_{EX1} between terminals No.4 (sensing terminal) and No.3 (output terminal) and R_{EX2} between terminals No.4 and No.1 (ground terminal).

The current I_{4IN} flowing into terminal No.4 is 1mA (typ.) so the thermal characteristics may be improved compared to the method shown in 1 by setting the external current I_{REX1} at approximately 5 times the value of I_{4IN} (stability coefficient $S=5$).

The adjusted output voltage V_{OUT} in this case is:

$$\begin{cases} V_O = V_{04} + R_{EX1} \cdot I_{REX1} \\ I_{REX1} = S \cdot I_{4IN} \end{cases}$$

The value of the external resistors may be obtained as follows:

$$R_{EX1} = \frac{V_O - V_{04}}{S \cdot I_{4IN}}, \quad R_{EX2} = \frac{V_{04}}{(S-1) \cdot I_{4IN}}$$

* V_{04} : Output voltage of SI-3000F series

S: Stability coefficient of I_{4IN} (may be set to any value)

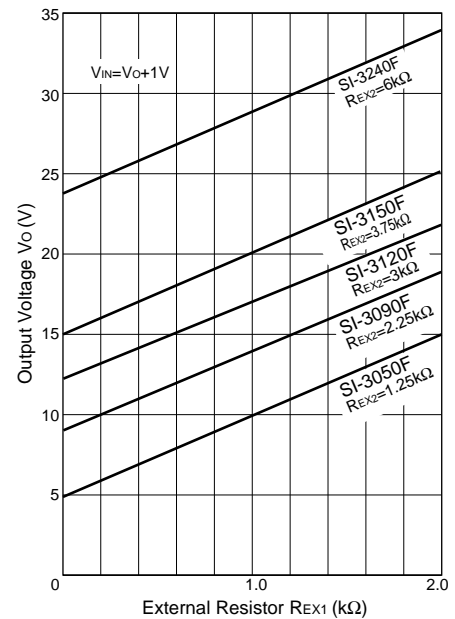

Note: In the SI-3000F series, the output voltage increase can be adjusted as mentioned above. However, when the rise is set to approximately 10V compared to output voltage V_{04} , the necessary output current may not be obtained due to the S.O.A. protection circuit in the SI-3000F series.

■Typical Characteristics

($T_a=25^\circ\text{C}$)

I_o vs. V_{DIF} Characteristics

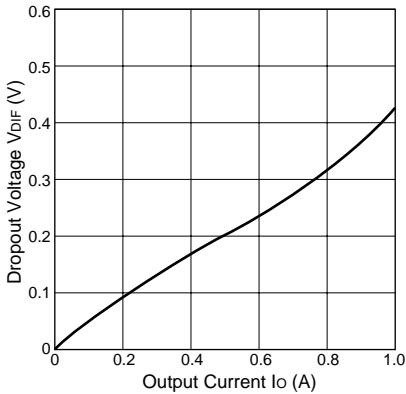

Temperature Coefficient of Output Voltage(SI-3050F)

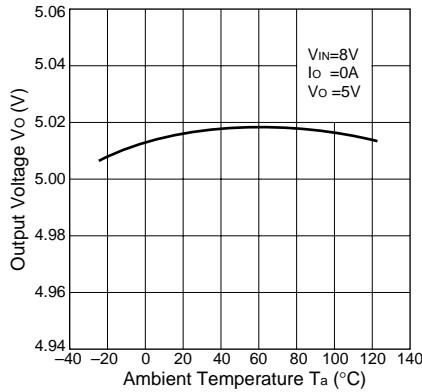

Output ON/OFF Control(SI-3050F)

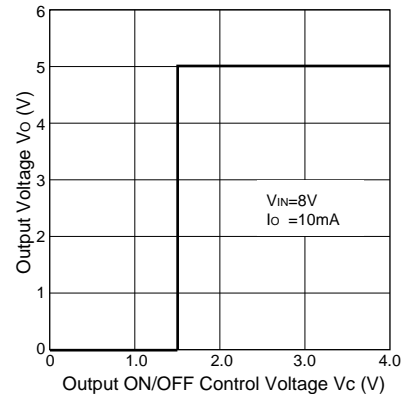

Rise Characteristics(SI-3050F)

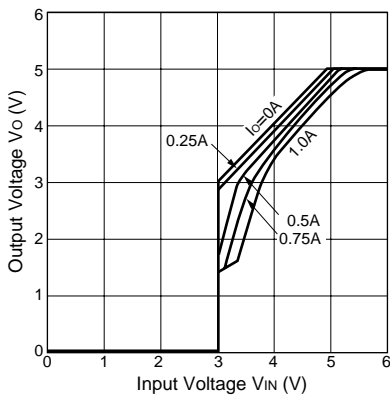

Rise Characteristics(SI-3120F)

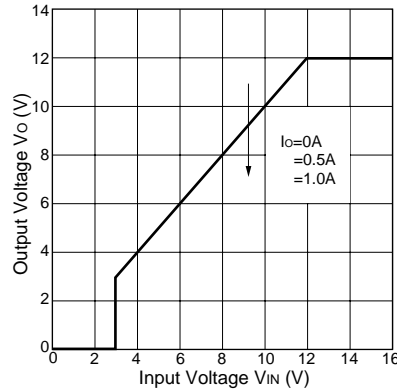

Overcurrent Protection Characteristics(SI-3050F)

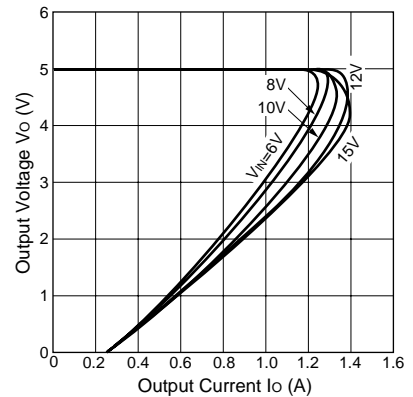

Overcurrent Protection Characteristics(SI-3120F)

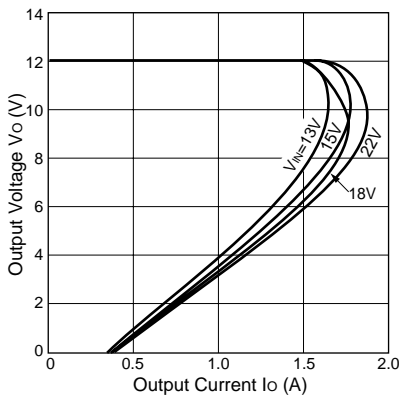

Overcurrent Protection Characteristics(SI-3140F)

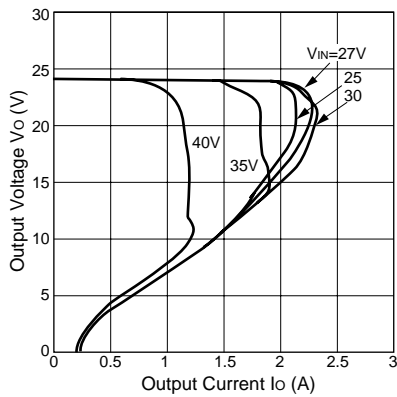

Thermal Protection Characteristics(SI-3050F)

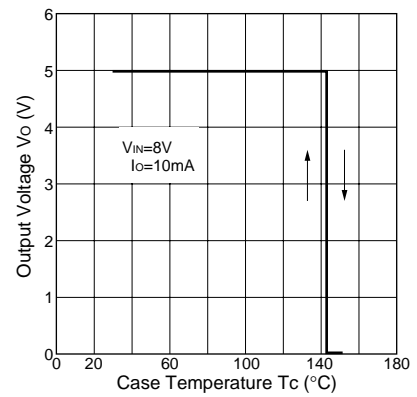

Note on Thermal Protection:

The thermal protection circuit is intended for protection against heat during instantaneous short-circuiting. Its operation is not guaranteed for short-circuiting over extended periods of time.