

NMOS 4-BIT MICROCONTROLLER

TMP4746N

The 4746 is a high speed and high performance 4-bit single chip microcomputer based on the TLCS-47 NMOS series with expansion input and output ports. TMP47C960AE in the CMOS series can be used as piggyback.

PART No.	ROM	RAM	PACKAGE
TMP4746N	4096 × 8-bit	256 × 4-bit	SDIP64

FEATURES

- ◆ 4-bit single chip microcomputer
- ◆ Instruction execution time : 1.9 μ s (at 4.2MHz)
- ◆ 90 basic instructions
- ◆ Table look-up instructions
- ◆ 5-bit to 8-bit data conversion instruction
- ◆ Subroutine nesting : 15 levels max.
- ◆ 6 interrupt sources (External : 2, Internal : 4)
All sources have independent latches each, and multiple interrupt control is available.
- ◆ I/O port (57 pins)
 - Input 1 port 4 pins
 - Output 4 ports 16 pins
 - I/O 10 ports 37 pins
- ◆ Interval Timer
- ◆ Two 12-bit Timer/Counters
Timer, event counter, and pulse width measurement mode
- ◆ Serial Interface with 4-bit buffer
External/internal clock, and leading/trailing edge shift mode
- ◆ High current outputs
LED direct drive capability (typ.20mA × 8bits)
- ◆ Memory holding function
Battery back-up
- ◆ Real Time Emulator : BM4721A + BM4724A

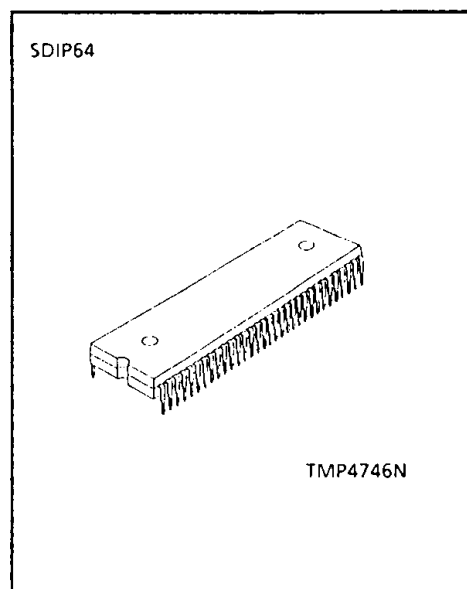

PIN ASSIGNMENT (TOP VIEW)

SDIP64

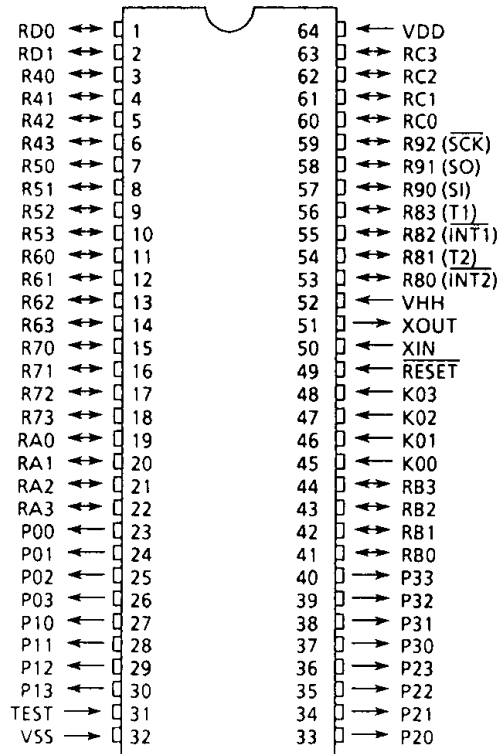

BLOCK DIAGRAM

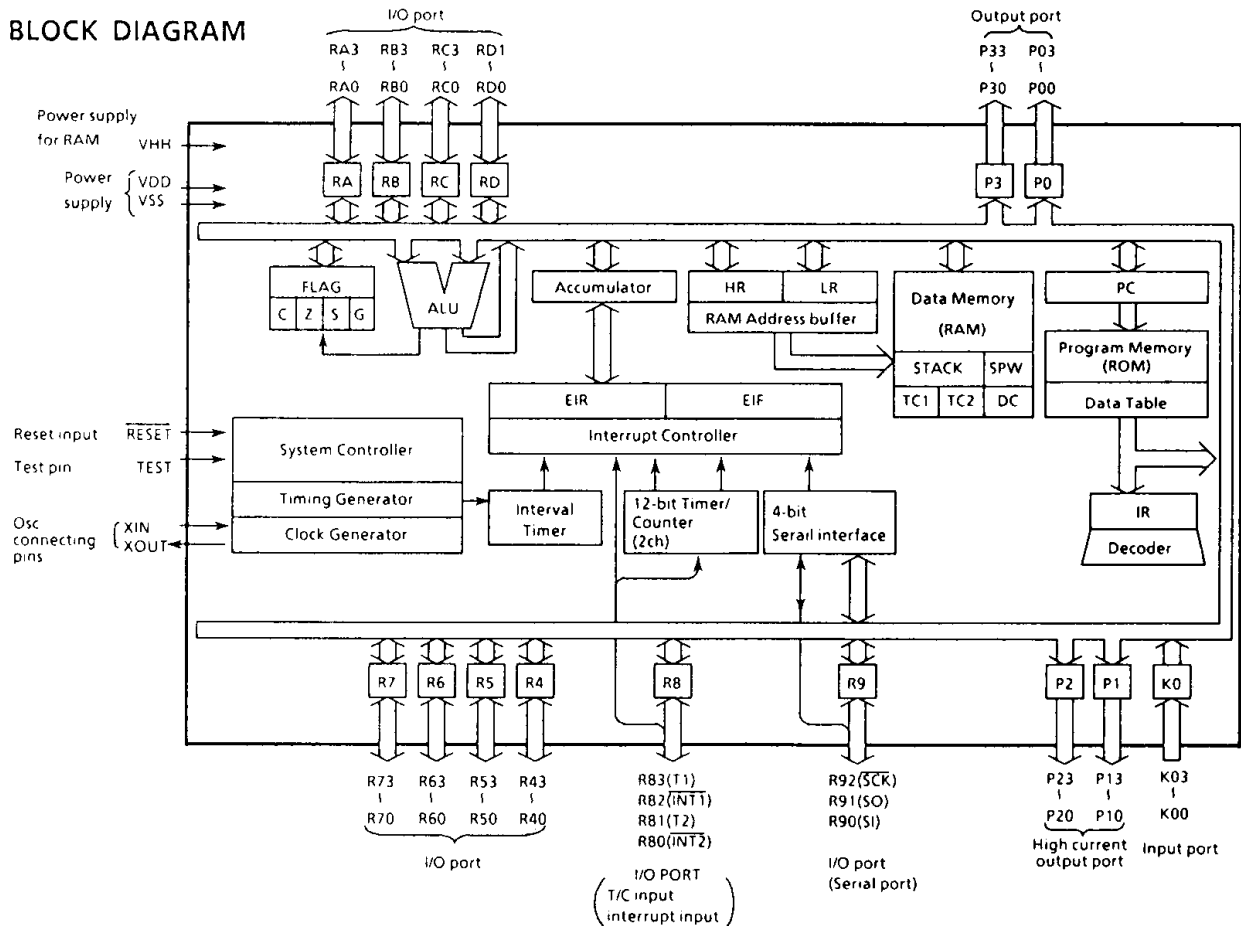

PIN FUNCTION

PIN NAME	Input/Output	FUNCTIONS	
K03 - K00	Input	4-bit input port	
P03 - P00	Output	4-bit output port with latch	
P13 - P10	Output	4-bit output port with latch.	
P23 - P20		8-bit data are output by the 5-bit to 8-bit data conversion instruction [OUTB @HL].	
P33 - P30	Output	4-bit output port with latch	
R43 - R40	I/O	4-bit I/O port with latch.	
R53 - R50		When used as input port, the latch must be set to "1".	
R63 - R60		Every bit data is possible to be set, cleared and tested by the bit manipulation of the L-register indirect addressing.	
R73 - R70			
RA3 - RA0	I/O	4-bit I/O port with latch (RD port has only 2-bit).	
RB3 - RB0		When used as input port, the latch must be set to "1".	
RC3 - RC0			
RD1 - RD0			
R83 (T1)	I/O (Input)	4-bit I/O port with latch.	Timer/Counter 1 external input
R82 ($\overline{\text{INT1}}$)		When used as input port, external interrupt input pin, or timer/counter input pin, the latch must be set to "1".	External interrupt 1 input
R81 (T2)			Timer/Counter 2 external input
R80 ($\overline{\text{INT2}}$)			External interrupt 2 input
R92 ($\overline{\text{SCK}}$)	I/O (I/O)	3-bit I/O port with latch.	Serial clock I/O
R91 (SO)	I/O (Output)	When used as input port or serial port, the latch must be set to "1".	Serial data output
R90 (SI)	I/O (Input)		Serial data input
XIN	Input	Resonator connecting pins.	
XOUT	Output	For inputting external clock, XIN is used and XOUT is opened.	
$\overline{\text{RESET}}$	Input	Reset signal input	
TEST	Input	Test pin for out-going test. Be opened or fixed to low level.	
VDD	Power supply	+ 5V	
VHH		+ 5V (Power supply for RAM)	
VSS		0V (GND)	

OPERATIONAL DESCRIPTION

The 4746 functions similarly to the 4740 except the expanded I/O ports. Refer to the technical data sheets for the 47C400A, except the expanded I/O ports and the memory holding function explained below. (The 4746, however does not have a built-in hold function.)

1. I/O PORTS

The 4746 has 15 ports (57 pins). The ports P0, P3, RA, R3, RC and RD address to the 4740 are explained as follows :

(1) Ports P0 (P03 - P00) and P3 (P33 - P30)

The 4-bit output port with latch. The latch is initialized to "0" during reset.

When an input instruction is executed, the latch data are read as the port P3 but the port P0.

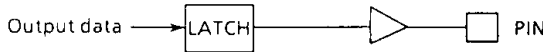
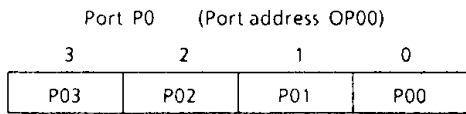

Figure1-1. Port P0

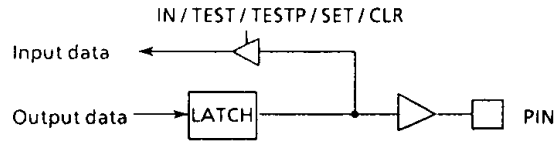
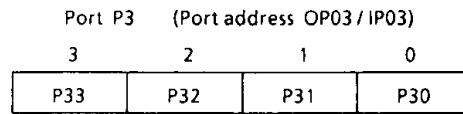
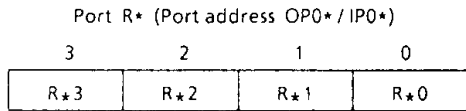

Figure1-2. Port P3

(2) Ports RA (RA3 - RA0), RB (RB3 - RB0), RC (RC3 - RC0), RD (RD1, RD0)

The 4-bit I/O ports with latch (port RD has only 2-bit). The latch is initialized to "1" during reset.

When used as input port, the latch must be set to "1". The 4746 has no RD2 and RD3 pins. However, when an input instruction is executed, the data "1" are read as RD2 and RD3.



* : AH, BH, CH

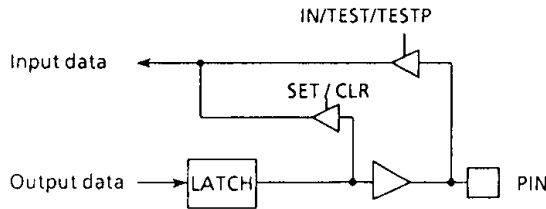
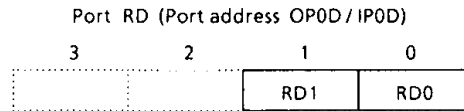

Figure1-3. Ports RA through RD

2. MEMORY HOLDING FUNCTION

By connecting a back-up power supply to the VHH pin, the RAM data can be protected with low power consumption even if VDD is cut off. The following procedure is used for memory holding operation.

- ① $\overline{\text{RESET}}$ pin is set to "low" level before VDD drops below the minimum operating voltage.
- ② Even if VDD is cut off, $\overline{\text{RESET}}$ pin is set to "low" level and VHH is kept at a voltage higher than the minimum holding voltage.
- ③ When the system returns to normal operation made from memory holding operation mode, after VHH and then VDD are confirmed to be at the minimum operating voltage or higher, $\overline{\text{RESET}}$ pin is set to "high" level (Reset is released).

This function makes it possible to conserve power during stand-by.

With the NMOS series, the power for the data memory (RAM) and reset circuit is supplied through VHH. Thus, it is necessary that operating voltage is applied to both pins VDD and VHH.

ELECTRICAL CHARACTERISTICS

ABSOLUTE MAXIMUM RATINGS

(V_{SS} = 0V)

PARAMETER	SYMBOL	PINS	RATING	UNIT
Supply Voltage	V _{DD}		- 0.5 to 7	V
	V _{HH}			
Input Voltage	V _{IN}		- 0.5 to 7	V
Output Voltage	V _{OUT1}	Except sink open drain pin	- 0.5 to 7	V
	V _{OUT2}	Sink open drain pin	- 0.5 to 10	
Output Current (Per 1 pin)	I _{OUT}	Ports P1, P2	30	mA
Power Dissipation [T _{opr} = 70°C]	PD		1000	mW
Soldering Temperature (time)	T _{sld}		260 (10sec)	°C
Storage Temperature	T _{stg}		- 55 to 125	°C
Operating Temperature	T _{opr}		- 30 to 70	°C

RECOMMENDED OPERATING CONDITIONS

(V_{SS} = 0V, T_{opr} = - 30 to 70°C)

PARAMETER	SYMBOL	PINS	CONDITIONS	Min.	Max.	UNIT
Supply Voltage	V _{DD}		In the Normal mode	4.5	5.5	V
	V _{HH}					
Input High Voltage	V _{IH1}	Ports R4 to R7		2.2	V _{DD}	V
	V _{IH2}	Except ports R4 to R7				
Input Low Voltage	V _{IL1}	Except port K0		0	0.8	V
	V _{IL2}	Port K0				
Clock Frequency	f _c			0.4	4.2	MHz

D. C. CHARACTERISTICS

 $(V_{SS} = 0V, T_{opr} = -30 \text{ to } 70^\circ\text{C})$

PARAMETER	SYMBOL	PINS	CONDITIONS	Min.	Typ.	Max.	UNIT
Hysteresis Voltage	V_{HS}	Hysteresis input		—	0.5	—	V
Input Current	I_{IN1}	Port K0, RESET, TEST	$V_{DD} = V_{HH} = 5.5V, V_{IN} = 5.5V$	—	—	20	μA
	I_{IN2}	Open drain port R	$V_{DD} = 5.5V, V_{IN} = 0.5V$	—	—	20	
Input Low Current	I_{IL}	Port R with pull-up resistor	$V_{DD} = 5.5V, V_{IN} = 0.4V$	—	—	-2	mA
Output Leakage Current	I_{LO}	All the open drain port	$V_{DD} = 5.5V, V_{OUT} = 0.5V$	—	—	20	μA
Output High Voltage	V_{OH}	All the port with pull-up resistor	$V_{DD} = 4.5V, I_{OH} = -200\mu\text{A}$	2.4	—	—	V
Output Low voltage	V_{OL}	Except XOUT and ports P1, P2	$V_{DD} = 4.5V, I_{OL} = 1.6\text{mA}$	—	—	0.4	
Output Low Current	I_{OL}	Ports P1, P2	$V_{DD} = 4.5V, V_{OL} = 1.0V$	—	20	—	mA
Supply Current (in the Normal mode)	$I_{DD} + I_{HH}$		$V_{DD} = V_{HH} = 5.5V$	—	80	135	mA
Supply Current (in the memory holding mode)	I_{HH}		$V_{DD} = V_{SS}, V_{HH} = 3.5V$	—	5	10	

Note 1. Typ. values show those at $T_{opr} = 25^\circ\text{C}, V_{DD} = V_{HH} = 5V$.

Note 2. Input Current I_{IN1} : The current through resistor is not included, when the pull-up/pull-down resistor is contained.

A. C. CHARACTERISTICS ($V_{SS} = 0V, V_{DD} = V_{HH} = 4.5 \text{ to } 5.5V, T_{opr} = -30 \text{ to } 70^\circ\text{C}$)

PARAMETER	SYMBOL	CONDITIONS	Min.	Typ.	Max.	UNIT
Instruction Cycle Time	t_{cy}		1.9	—	20	μs
High level Clock pulse Width	t_{wCH}	For external clock operation	80	—	—	ns
Low level Clock pulse Width	t_{wCL}					
Shift Data Hold Time	t_{SDH}		$0.5t_{cy} - 300$	—	—	ns

Note. Shift Data Hold Time :

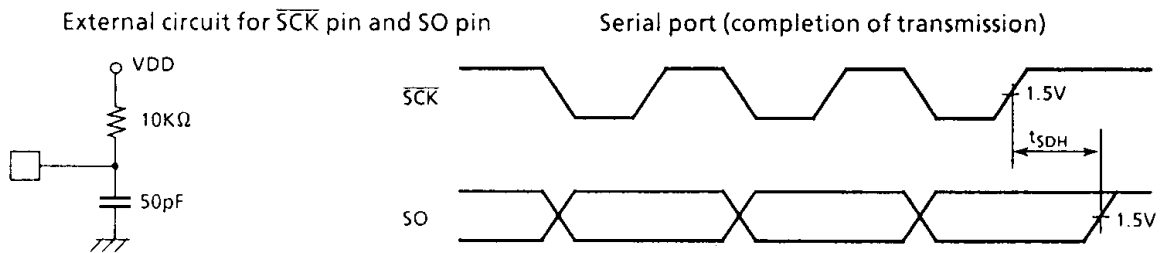

RECOMMENDED OSCILLATING CONDITIONS ($V_{SS} = 0V, V_{DD} = V_{HH} = 4.5 \text{ to } 5.5V, T_{opr} = -30 \text{ to } 70^\circ\text{C}$)

(1) 4MHz

Ceramic Resonator

CSA 4.00MG (MURATA)

$C_{XIN} = C_{XOUT} = 47\text{pF}$

KBR - 4.00MS (KYOCERA)

$C_{XIN} = C_{XOUT} = 47\text{pF}$

Crystal - Oscillator

204B - 6F 4.0000 (TOYOCOM)

$C_{XIN} = C_{XOUT} = 20\text{pF}$

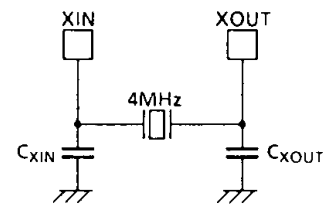

(2) 400KHz

Ceramic Resonator

CSA400B (MURATA)

$C_{XIN} = C_{XOUT} = 390\text{pF}, R_{XOUT} = 2.2\text{K}\Omega$
 $R_{XFB} = 1\text{M}\Omega$

KBR-400B (KYOCERA)

$C_{XIN} = C_{XOUT} = 390\text{pF}, R_{XOUT} = 2.2\text{K}\Omega$
 $R_{XFB} = 1\text{M}\Omega$

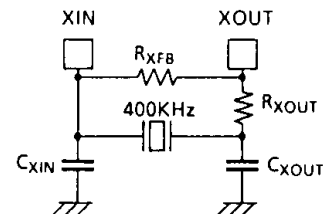

TYPICAL CHARACTERISTICS

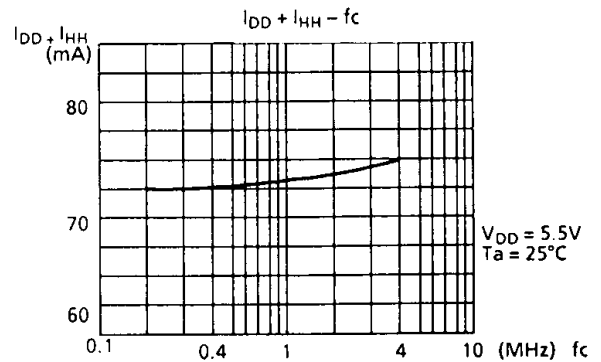
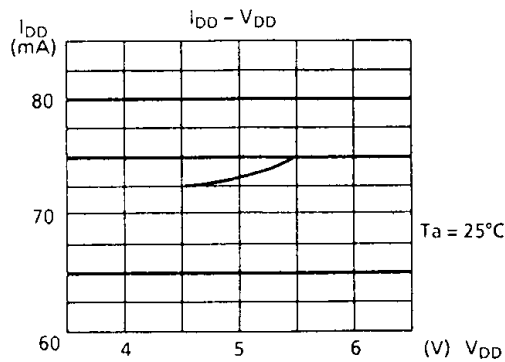
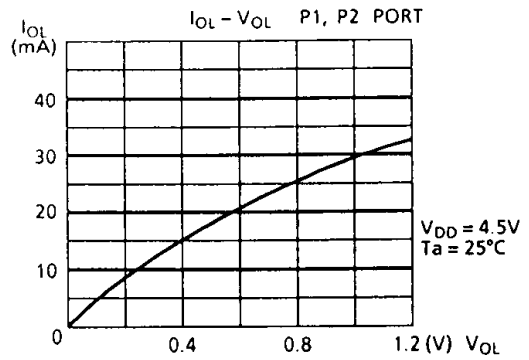
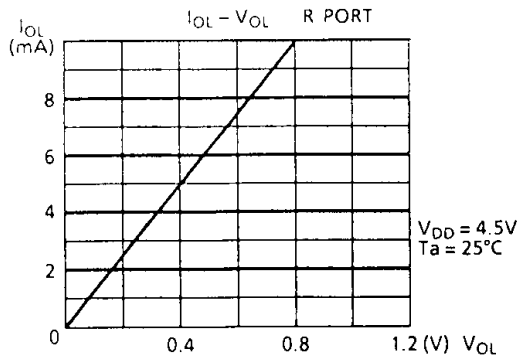
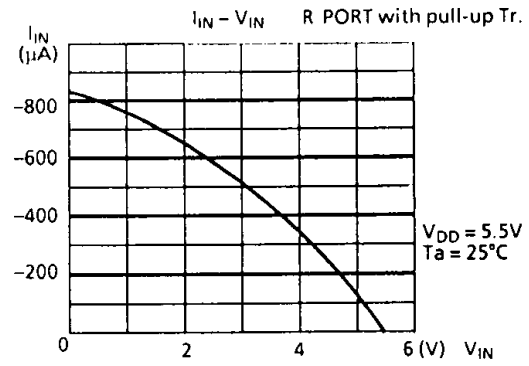
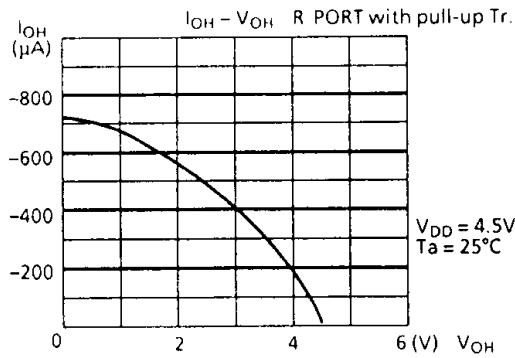
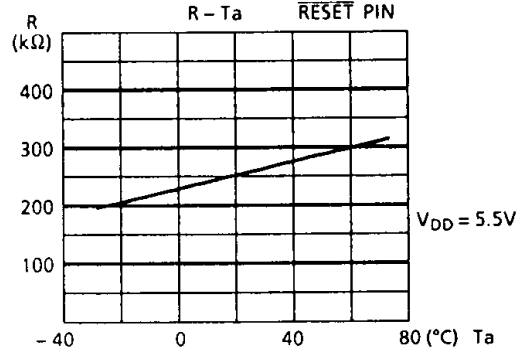
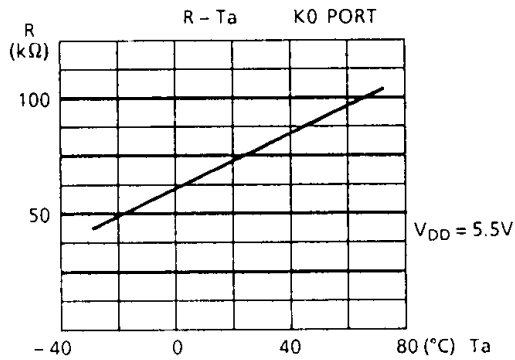

INPUT/OUTPUT CIRCUITRY

(1) Control pins

The input/output circuitries of the 4746 control pins are similar to that of the 4720/40.

(2) I/O ports

The input/output circuitries of the 4746 I/O ports are shown below, any one of the circuitries can be chosen by a code (KA-KC) as a mask option.

Port	I/O	INPUT/OUTPUT CIRCUITRY and CODE			REMARKS
		KA	KB	KC	
K0	Input				Pull-up/Pull-down resistor $R_{IN} = 100K\Omega$ (typ.) $R = 1K\Omega$ (typ.)
P0 P3	I/O				Sink open drain output Initial "Low" Pull-up resistor $R_L = 5K\Omega$ (typ.)
P1 P2	Output				Sink open drain output Initial "Hi-z" High current $I_{OL} = 20mA$ (typ.)
R4 R5 R6 R7	I/O				Sink open drain output Initial "Hi-z" $R = 1K\Omega$ (typ.)
R8 R9	I/O				Sink open drain output Initial "Hi-z" Hysteresis input $R = 1K\Omega$ (typ.)
RA RB RC RD	I/O				Sink open drain output Initial "High" Pull-up resistor $R_L = 5K\Omega$ (typ.) $R = 1K\Omega$ (typ.)