



# BDW93C BDW94B/BDW94C

## COMPLEMENTARY SILICON POWER DARLINGTON TRANSISTORS

- STMicroelectronics PREFERRED SALESTYPES
- COMPLEMENTARY PNP - NPN DEVICES
- INTEGRATED ANTIPARALLEL COLLECTOR-EMITTER DIODE

### APPLICATIONS

- LINEAR AND SWITCHING INDUSTRIAL EQUIPMENT

### DESCRIPTION

The BDW93C is a silicon Epitaxial-Base NPN power transistor in monolithic Darlington configuration mounted in Jedec TO-220 plastic package. It is intended for use in power linear and switching applications.

The complementary PNP type is BDW94C.

Also BDW94B is a PNP type.

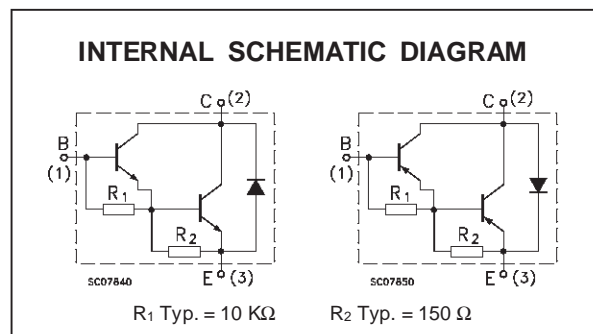
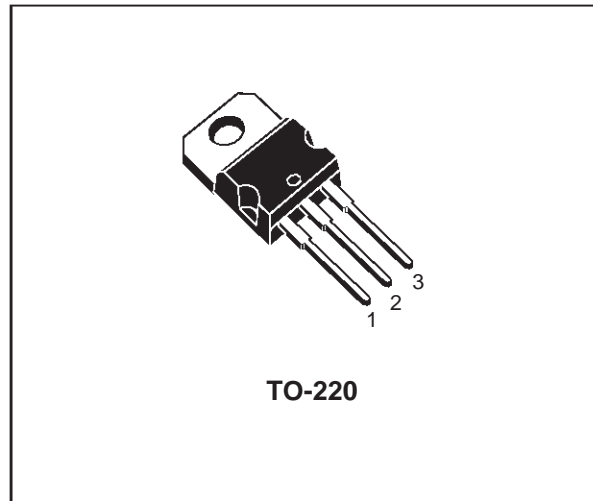

### ABSOLUTE MAXIMUM RATINGS

Symbol	Parameter	Value		Unit
		NPN	BDW93C	
		PNP	BDW94B	
$V_{CBO}$	Collector-Base Voltage ( $I_E = 0$ )	80	100	V
$V_{CEO}$	Collector-Emitter Voltage ( $I_B = 0$ )	80	100	V
$I_C$	Collector Current	12		A
$I_{CM}$	Collector Peak Current	15		A
$I_B$	Base Current	0.2		A
$P_{tot}$	Total Dissipation at $T_c \leq 25^\circ C$	80		W
$T_{stg}$	Storage Temperature	-65 to 150		$^\circ C$
$T_j$	Max. Operating Junction Temperature	150		$^\circ C$

For PNP types voltage and current values are negative.

## BDW93C/BDW94B/BDW94C

### THERMAL DATA

R <sub>thj-case</sub>	Thermal Resistance Junction-case	1.56	°C/W
-----------------------	----------------------------------	------	------

### ELECTRICAL CHARACTERISTICS (T<sub>case</sub> = 25 °C unless otherwise specified)

Symbol	Parameter	Test Conditions	Min.	Typ.	Max.	Unit
I <sub>CBO</sub>	Collector Cut-off Current (I <sub>E</sub> = 0)	for <b>BDW94B</b> V <sub>CB</sub> = 80 V for <b>BDW93C/94C</b> V <sub>CB</sub> = 100 V T <sub>case</sub> = 150 °C for <b>BDW94B</b> V <sub>CB</sub> = 80 V for <b>BDW93C/94C</b> V <sub>CB</sub> = 100 V			100 100 5 5	μA μA mA mA
I <sub>CEO</sub>	Collector Cut-off Current (I <sub>B</sub> = 0)	for <b>BDW94B</b> V <sub>CE</sub> = 80 V for <b>BDW93C/94C</b> V <sub>CE</sub> = 100 V			1 1	mA mA
I <sub>EBO</sub>	Emitter Cut-off Current (I <sub>C</sub> = 0)	V <sub>EB</sub> = 5 V			2	mA
V <sub>CEO(sus)*</sub>	Collector-Emitter Sustaining Voltage (I <sub>B</sub> = 0)	I <sub>C</sub> = 100 mA for <b>BDW94B</b> for <b>BDW93C/94C</b>	80 100			V V
V <sub>CE(sat)*</sub>	Collector-Emitter Saturation Voltage	I <sub>C</sub> = 5 A I <sub>B</sub> = 20 mA I <sub>C</sub> = 10 A I <sub>B</sub> = 100 mA			2 3	V V
V <sub>BE(sat)*</sub>	Base-Emitter Saturation Voltage	I <sub>C</sub> = 5 A I <sub>B</sub> = 20 mA I <sub>C</sub> = 10 A I <sub>B</sub> = 100 mA			2.5 4	V V
h <sub>FE*</sub>	DC Current Gain	I <sub>C</sub> = 3 A V <sub>CE</sub> = 3 V I <sub>C</sub> = 5 A V <sub>CE</sub> = 3 V I <sub>C</sub> = 10 A V <sub>CE</sub> = 3 V	1000 750 100		20K	
V <sub>F*</sub>	Parallel-diode Forward Voltage	I <sub>F</sub> = 5 A I <sub>F</sub> = 10 A		1.3 1.8	2 4	V V
h <sub>fe</sub>	Small Signal Current Gain	I <sub>C</sub> = 1 A V <sub>CE</sub> = 10 V f = 1 MHz	20			

\* Pulsed: Pulse duration = 300 μs, duty cycle 1.5 %  
For PNP types voltage and current values are negative.

Safe Operating Area

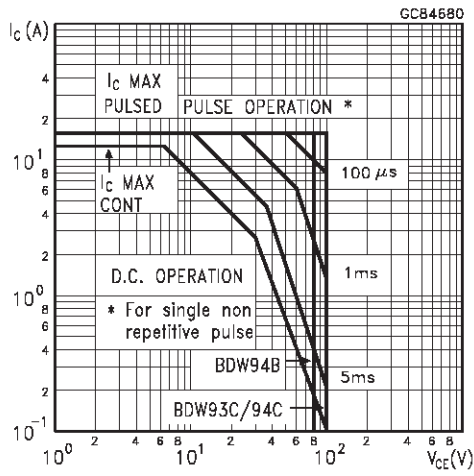

DC Current Gain (NPN types)

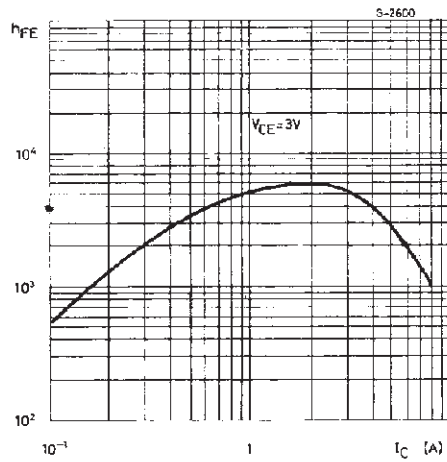

Collector Emitter Saturation Voltage (NPN types)

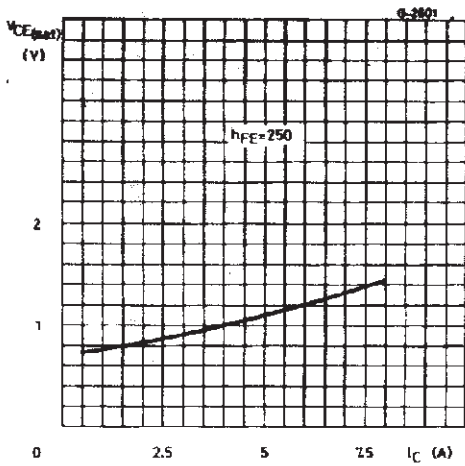

DC Transconductance (NPN types)

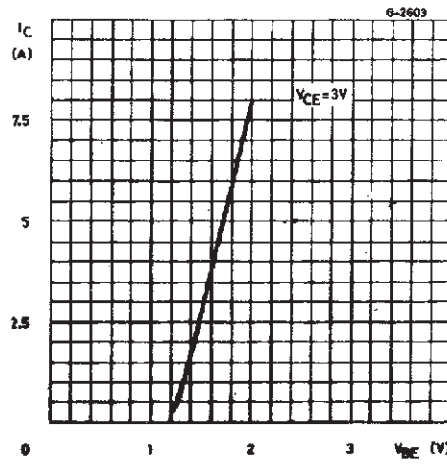

Collector Emitter Saturation Voltage (NPN types)

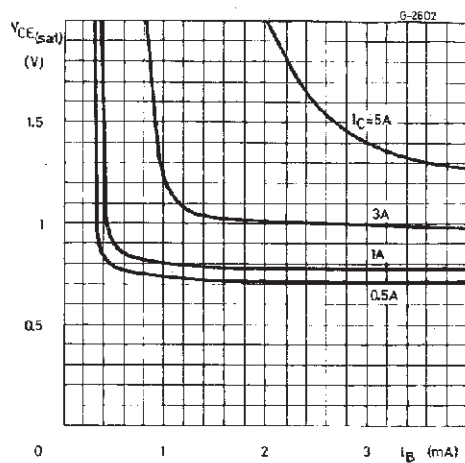

Collector Emitter Saturation Voltage (PNP types)

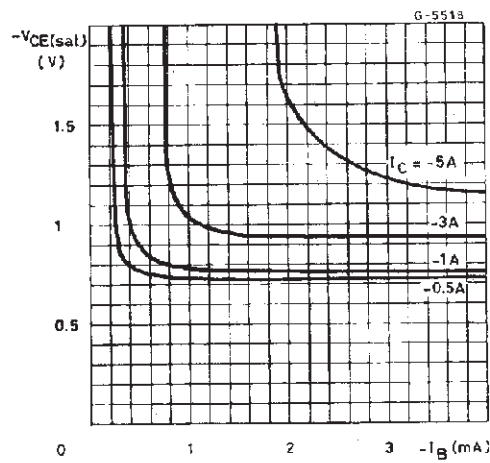

# BDW93C/BDW94B/BDW94C

Saturated Switching Characteristics (NPN types)

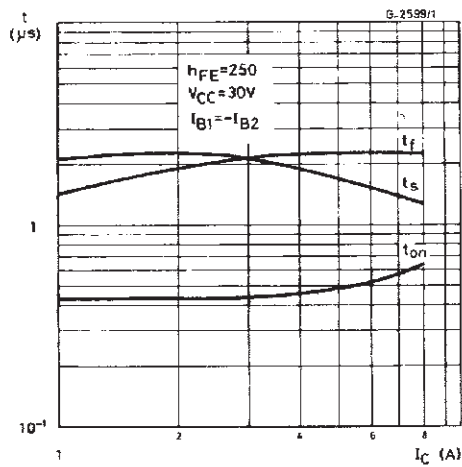

Saturated Switching Characteristics (PNP types)

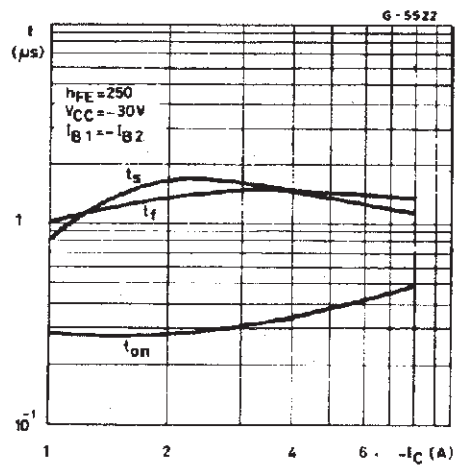

Collector Emitter Saturation Voltage (PNP types)

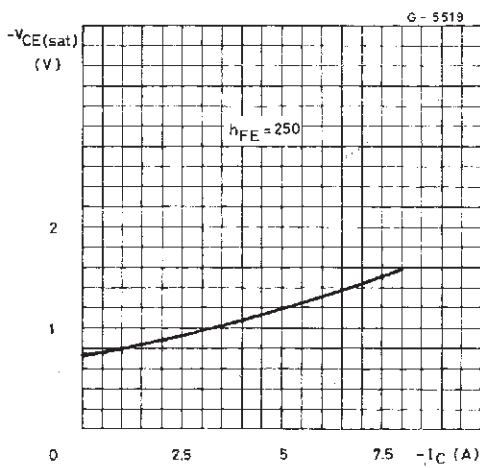

DC Current Gain (PNP types)

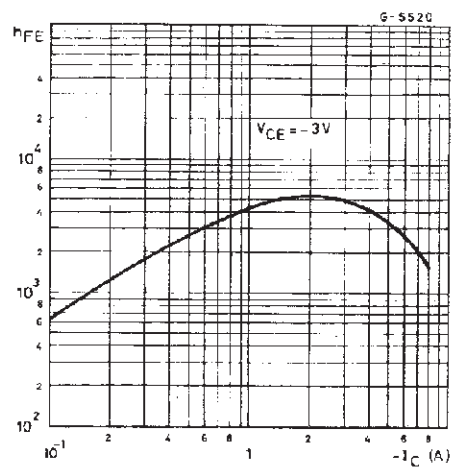

DC Transconductance (PNP types)

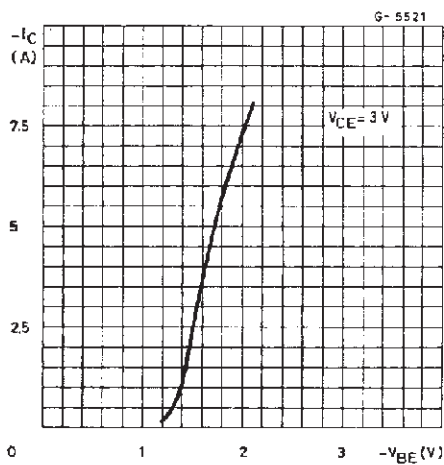

**TO-220 MECHANICAL DATA**

DIM.	mm			inch		
	MIN.	TYP.	MAX.	MIN.	TYP.	MAX.
A	4.40		4.60	0.173		0.181
C	1.23		1.32	0.048		0.051
D	2.40		2.72	0.094		0.107
D1		1.27			0.050	
E	0.49		0.70	0.019		0.027
F	0.61		0.88	0.024		0.034
F1	1.14		1.70	0.044		0.067
F2	1.14		1.70	0.044		0.067
G	4.95		5.15	0.194		0.203
G1	2.4		2.7	0.094		0.106
H2	10.0		10.40	0.393		0.409
L2		16.4			0.645	
L4	13.0		14.0	0.511		0.551
L5	2.65		2.95	0.104		0.116
L6	15.25		15.75	0.600		0.620
L7	6.2		6.6	0.244		0.260
L9	3.5		3.93	0.137		0.154
DIA.	3.75		3.85	0.147		0.151

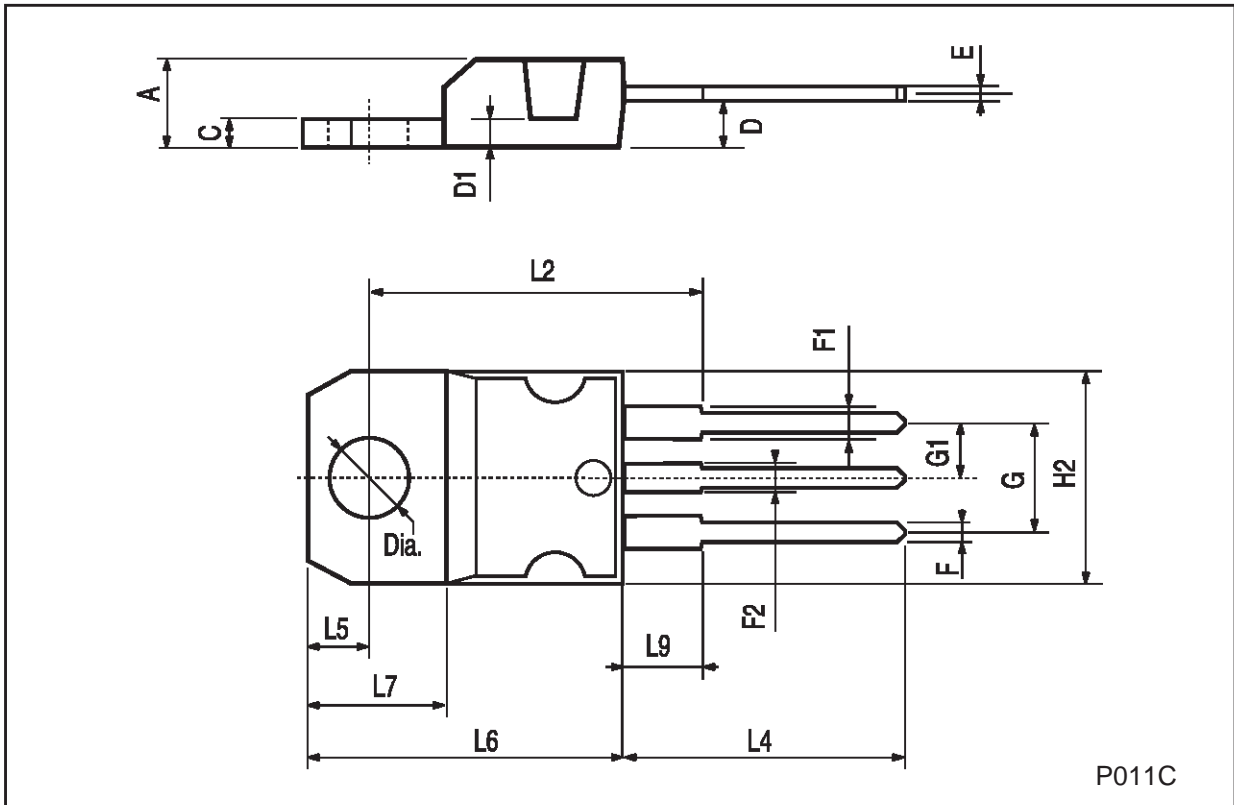

P011C

Information furnished is believed to be accurate and reliable. However, STMicroelectronics assumes no responsibility for the consequences of use of such information nor for any infringement of patents or other rights of third parties which may result from its use. No license is granted by implication or otherwise under any patent or patent rights of STMicroelectronics. Specification mentioned in this publication are subject to change without notice. This publication supersedes and replaces all information previously supplied. STMicroelectronics products are not authorized for use as critical components in life support devices or systems without express written approval of STMicroelectronics.

The ST logo is a trademark of STMicroelectronics

© 1999 STMicroelectronics – Printed in Italy – All Rights Reserved

STMicroelectronics GROUP OF COMPANIES

Australia - Brazil - China - Finland - France - Germany - Hong Kong - India - Italy - Japan - Malaysia - Malta - Morocco -  
Singapore - Spain - Sweden - Switzerland - United Kingdom - U.S.A.

<http://www.st.com>