

## 400mA SmartOR™ Dual Regulator with V<sub>AUX</sub> Switch

### Features

- Continuous 3.3V output from three inputs
- Complete power management solution
- V<sub>CC</sub>, V<sub>SBY</sub> regulator supplies 400mA output
- Built-in hysteresis when selecting input supplies
- Integrated switch has very low R<sub>DS(ON)</sub> 0.25Ω (TYP)
- Foldback current limiting protection
- Thermal overload shutdown protection
- 8-pin power SOIC package

### Applications

- PCI adapter cards with Wake-On-LAN
- Network Interface Cards (NICs)
- Multiple power systems
- Systems with standby capabilities

### Product Description

The CMPWR330 is a dual input regulator with a fully integrated V<sub>AUX</sub> switch capable of delivering up to 400mA continuously at 3.3V. The output power is provided from three independent input voltage sources on a prioritized basis. Power is always taken in priority using the following order V<sub>CC</sub>, V<sub>SBY</sub>, and V<sub>AUX</sub>.

When V<sub>CC</sub> (5V) or V<sub>SBY</sub> is present, the device automatically enables the regulator and produces a stable 3.3V output at V<sub>OUT</sub>.

When only V<sub>AUX</sub> (3.3V) is present, the device provides a low impedance direct connection (0.25Ω TYP) from V<sub>AUX</sub> to V<sub>OUT</sub>.

All the necessary control circuitry needed to provide a smooth and automatic transition between all three supplies has been incorporated. This allows the V<sub>CC</sub> input supply to be dynamically switched without loss of output voltage.

### PIN DIAGRAM AND ELECTRICAL SCHEMATIC

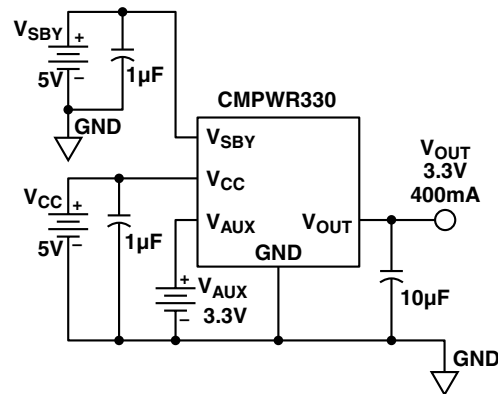
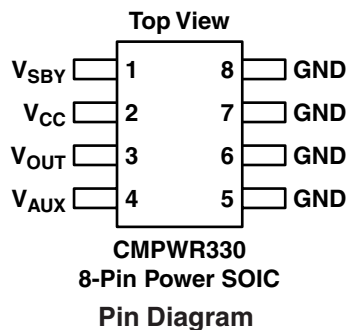

### STANDARD PART ORDERING INFORMATION

Package		Ordering Part Number		
Pins	Style	Tubes	Tape & Reel	Part Marking
8	Power SOIC	CMPWR330SA/T	CMPWR330SA/R	CMPWR330SA

ABSOLUTE MAXIMUM RATINGS		
Parameter	Rating	Unit
ESD Protection (HBM)	2000	V
V <sub>CC</sub> , V <sub>SBY</sub> Input Voltage	6.0, GND -0.5	V
V <sub>AUX</sub> Input Voltage	4.0, GND -0.5	V
Temperature: Storage	-40 to 150	°C
Operating Ambient	0 to 70	°C
Operating Junction	0 to 125	°C
Power Dissipation: (Note 1)	Internally Limited	W

OPERATING CONDITIONS		
Parameter	Range	Unit
V <sub>CC</sub> , V <sub>SBY</sub>	5 ± 0.25	V
V <sub>AUX</sub>	3.3 ± 0.3	V
Temperature (Ambient)	0 to 70	°C
Load Current	0 to 400	mA
C <sub>EXT</sub>	10 ± 20%	µF

ELECTRICAL OPERATING CHARACTERISTICS (over operating conditions unless specified otherwise)						
Symbol	Parameter	Conditions	MIN	TYP	MAX	UNIT
V <sub>OUT</sub>	Regulator Output Voltage	0mA < I <sub>LOAD</sub> < 400mA	3.135	3.30	3.465	V
I <sub>LIM</sub>	Regulator Current Limit			500		mA
I <sub>S/C</sub>	Short Circuit Current	V <sub>CC</sub> /S <sub>BY</sub> = 5V, V <sub>out</sub> = 0V		150		mA
V <sub>R LOAD</sub>	Load Regulation	V <sub>CC</sub> = 5V, I <sub>LOAD</sub> = 5 to 400mA		20		mV
V <sub>R LINE</sub>	Line Regulation	V <sub>CC</sub> = 4.5V to 5.5V, I <sub>LOAD</sub> = 5mA		2		mV
V <sub>CCSEL</sub>	V <sub>CC</sub> Select Voltage	V <sub>SBY</sub> or V <sub>AUX</sub> present		4.40	4.60	V
V <sub>CCDES</sub>	V <sub>CC</sub> Deselect Voltage	V <sub>SBY</sub> or V <sub>AUX</sub> present	4.00	4.20		V
V <sub>HYST</sub>	Hysteresis Voltage (Note 2)	V <sub>SBY</sub> or V <sub>AUX</sub> present		0.20		V
R <sub>SW</sub>	V <sub>AUX</sub> Switch Resistance			0.25	0.4	Ω
I <sub>RCC</sub>	V <sub>CC</sub> Reverse Leakage	One supply input taken to ground while the others remain at nominal voltage				
I <sub>R<sub>SBY</sub></sub>	V <sub>SBY</sub> Reverse Leakage			5	100	µA
I <sub>R<sub>AUX</sub></sub>	V <sub>AUX</sub> Reverse Leakage					
I <sub>CC</sub>	V <sub>CC</sub> Supply Current	V <sub>CC</sub> > V <sub>CCSEL</sub> , I <sub>LOAD</sub> = 0mA		0.8	1.5	mA
I <sub>SBY</sub>	V <sub>SBY</sub> Supply Current	V <sub>CC</sub> < V <sub>CCDES</sub> , I <sub>LOAD</sub> = 0mA		0.8	1.5	mA
I <sub>AUX</sub>	V <sub>AUX</sub> Supply Current	V <sub>AUX</sub> is selected, I <sub>LOAD</sub> = 0mA		0.2	0.30	mA
I <sub>GND</sub>	Ground Current	V <sub>AUX</sub> is selected, (V <sub>CC</sub> /S <sub>BY</sub> = 0V)		0.2	0.30	mA
		V <sub>CC</sub> /S <sub>BY</sub> = 5V, I <sub>LOAD</sub> = 0mA		0.8	1.5	mA
		V <sub>CC</sub> /S <sub>BY</sub> = 5V, I <sub>LOAD</sub> = 400mA		1.0	2.0	mA
T <sub>DISABLE</sub>	Shutdown Temperature			160		°C
T <sub>HYST</sub>	Thermal Hysteresis			20		°C

**Note 1:** At rated load, the power dissipation will be 0.68W (1.7V x 0.4A). Under these conditions, (in a 70°C ambient), the thermal resistance from junction to ambient ( $\theta_{JA}$ ) must not exceed 80°C/W. This is typically achieved with 2 square inches of copper printed circuit board area connected to the GND pins for heat spreading, or equivalent.

**Note 2:** The disturbance on V<sub>CC</sub> during supply changeover should be kept below the hysteresis voltage to prevent any chatter. The source resistance on the V<sub>CC</sub> supply should be kept to less than 0.3Ω to ensure precise switching.

## Interface Signals

$V_{CC}$  is a positive input supply for the voltage regulator. Whenever this supply voltage exceeds the  $V_{CCSEL}$  level (4.4V), it will immediately be given priority and be used to power the regulator output. If this supply voltage falls below the  $V_{CCDES}$  level (4.2V) it will immediately be deselected and no longer provide power for the regulator output. An internal hysteresis voltage of 0.2V is used to prevent any chatter during selection and deselection of  $V_{CC}$ . The effective source impedance of  $V_{CC}$  should be kept below  $0.3\Omega$  to ensure changeover disturbances do not exceed the hysteresis level.

If the connection to  $V_{CC}$  is made within a few inches of the main input filter, a bypass capacitor may not be necessary. Otherwise a bypass filter capacitor in the range of  $1\mu F$  to  $10\mu F$  will ensure adequate filtering.

$V_{SBY}$  is the standby input supply (5V), which is immediately used to power the regulator output whenever  $V_{CC}$  is below the deselect level (4.2V).

If the  $V_{SBY}$  connection is made within a few inches of the main input filter, a bypass capacitor may not be necessary. Otherwise a bypass filter capacitor in the range of  $1\mu F$  to  $10\mu F$  will ensure adequate filtering.

$V_{AUX}$  is the auxiliary voltage power source. This supply is selected only when  $V_{CC}$  falls below 4.2V and the  $V_{SBY}$  is not present. Under these conditions an internal switch is enabled and provides a very low impedance connection directly between  $V_{OUT}$  and  $V_{AUX}$ .

$V_{OUT}$  is the output voltage. Power is provided from the regulator or via the low impedance auxiliary switch. This output requires a capacitance of  $10\mu F$  to ensure regulator stability and minimize the peak output disturbance during power supply changeover.

**GND** provides the reference for all voltages.

INTERFACE SIGNALS		
Pin	Symbol	Description
1	$V_{SBY}$	Standby supply voltage (5V) input for regulator whenever $V_{CC}$ falls below 4.2V.
2	$V_{CC}$	Primary supply voltage (5V) input for regulator
3	$V_{OUT}$	Regulator voltage output (3.3V) regulator when either $V_{CC}$ or $V_{SBY}$ is present
4	$V_{AUX}$	Auxiliary supply voltage (3.3V) input for low impedance switch
5 - 8	GND	Reference for all voltages

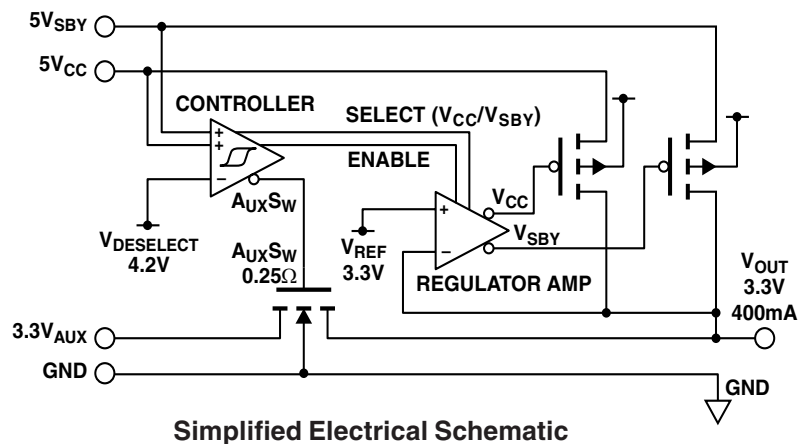

Typical DC Characteristics (nominal conditions unless specified otherwise)

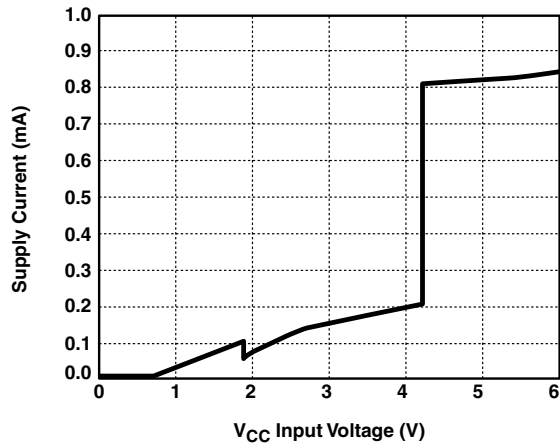

Figure 1. V<sub>CC</sub> Supply Current vs Voltage

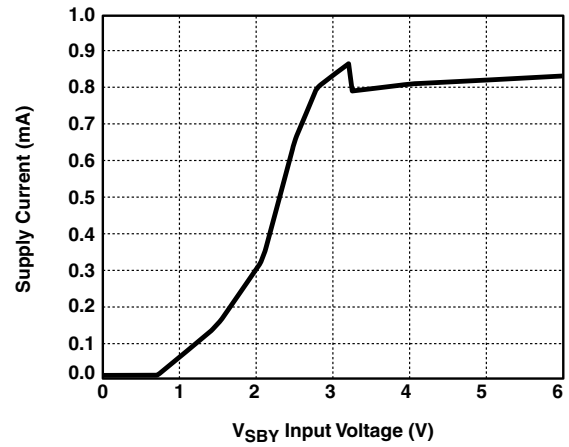

Figure 2. V<sub>SBY</sub> Supply Current vs Voltage

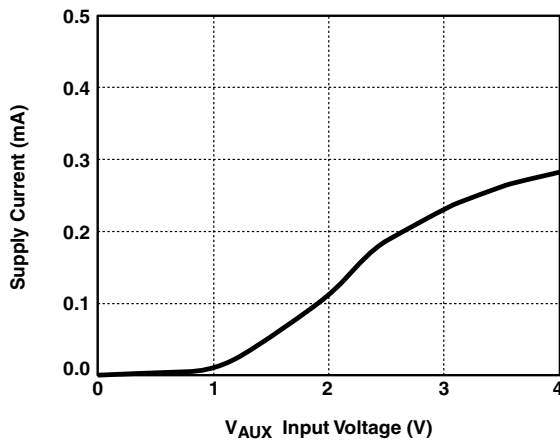

Figure 3. V<sub>AUX</sub> Supply Current vs Voltage

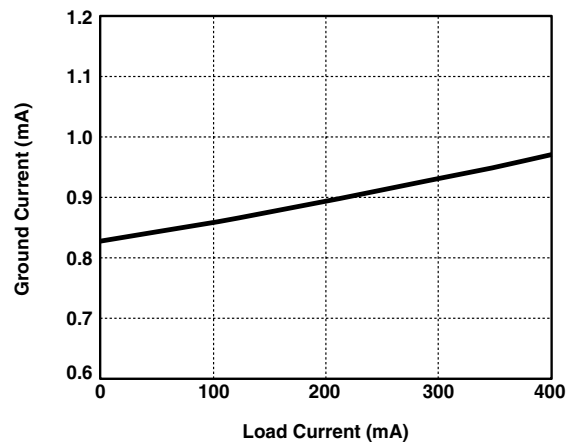

Figure 4. Ground Current vs Output Load

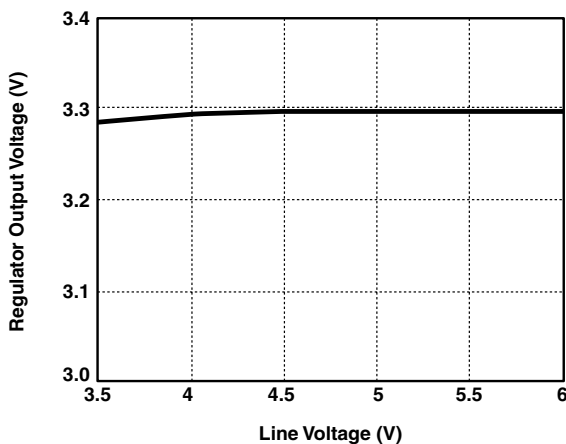

Figure 5. Line Regulation (5mA Load)

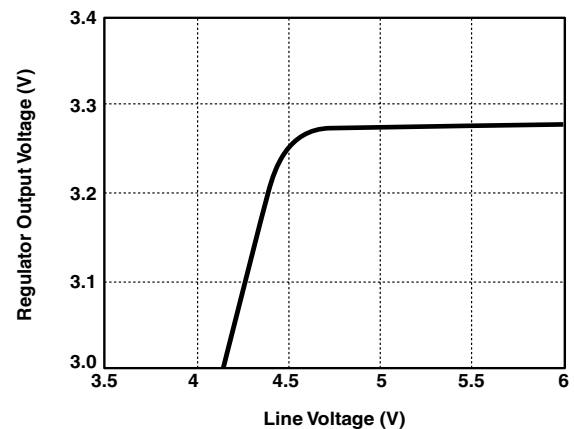

Figure 6. Line Regulation (400mA Load)

Typical DC Characteristics

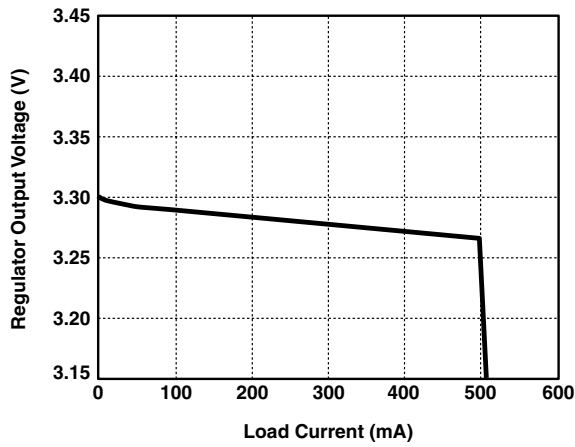

Figure 7. Load Regulation (5V Supply)

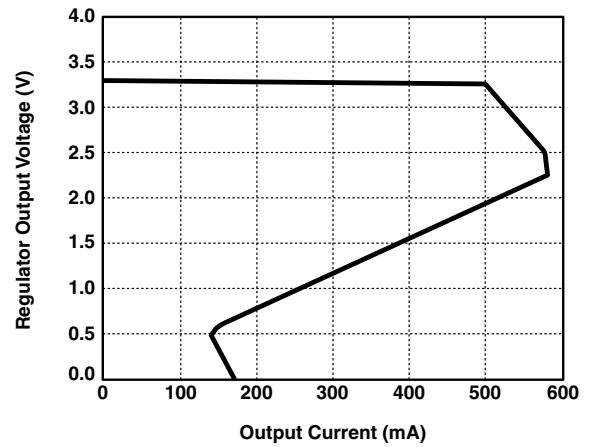

Figure 8. Foldback Current Limit Protection

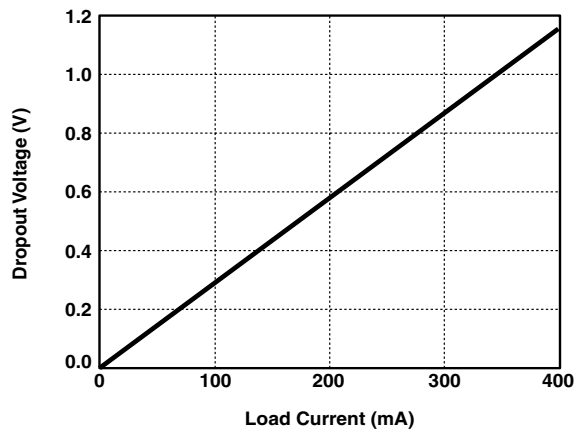

Figure 9. Regulator Dropout Characteristics

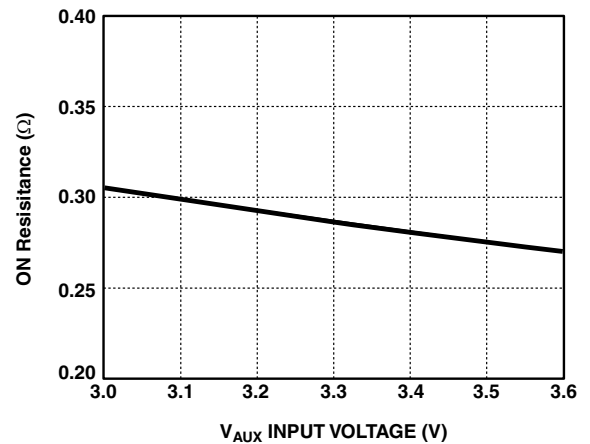

Figure 10. Switch Resistance vs V<sub>AUX</sub> Supply

Typical Transient Characteristics (Supply source resistance set to  $0.2\Omega$ )

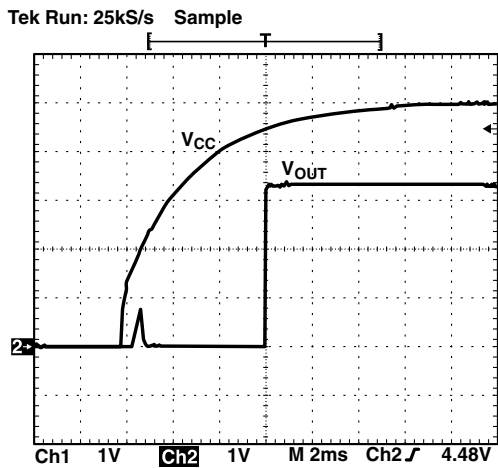

Figure 11.  $V_{CC}$  Cold Start (Load = 400mA)

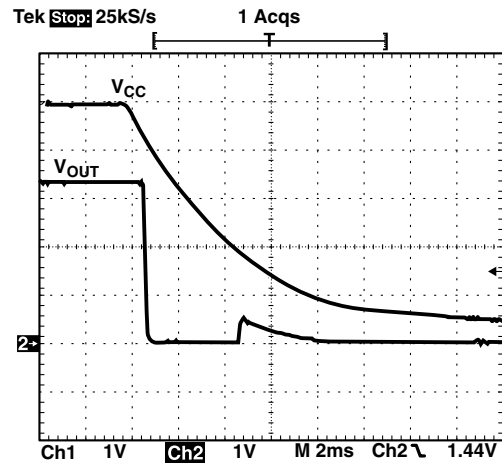

Figure 12.  $V_{CC}$  Full Power Down (Load = 400mA)

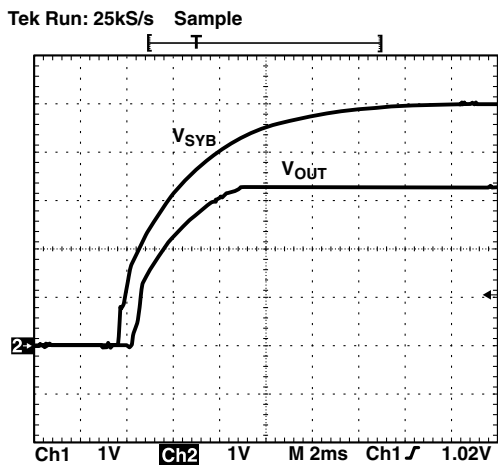

Figure 13.  $V_{SBY}$  Cold Start (Load = 400mA)

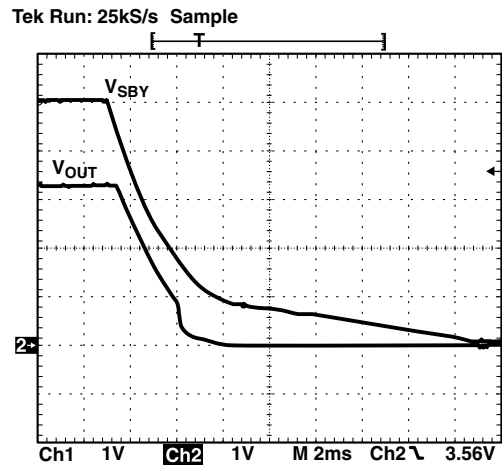

Figure 14.  $V_{SBY}$  Full Power Down (Load = 400mA)

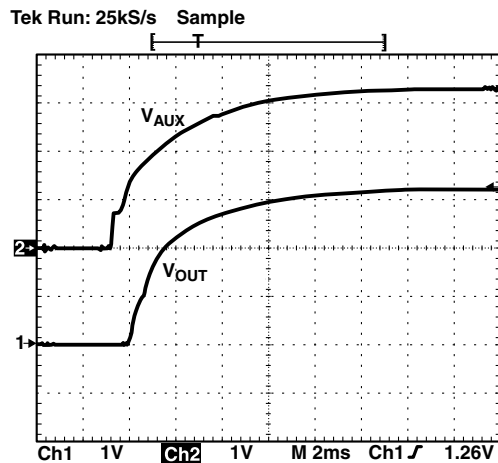

Figure 15.  $V_{AUX}$  Cold Start (Load = 400mA)

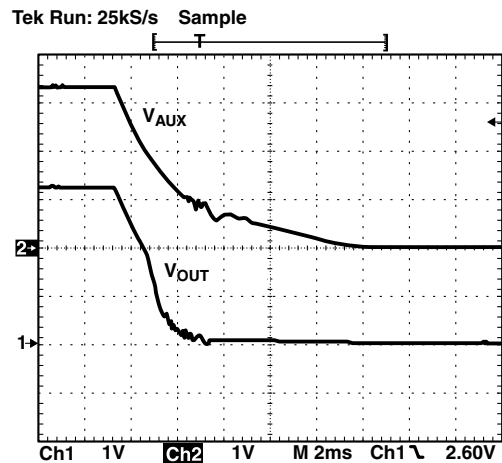

Figure 16.  $V_{AUX}$  Full Power Down (Load = 400mA)

Typical Transient Characteristics ( $V_{CC}$  source resistance set to  $0.2\Omega$ )

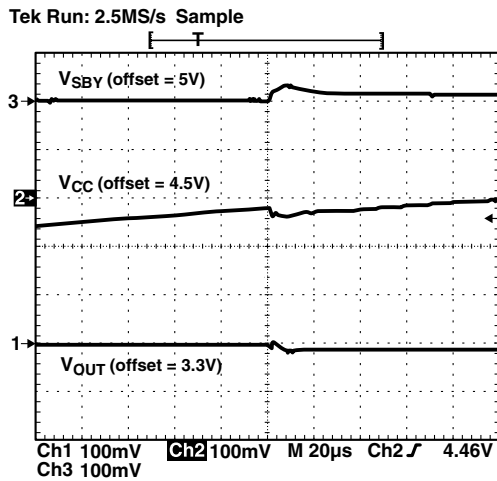

Figure 17.  $V_{CC}$  Power Up ( $V_{SBY} = 5V$ , Load = 300mA)

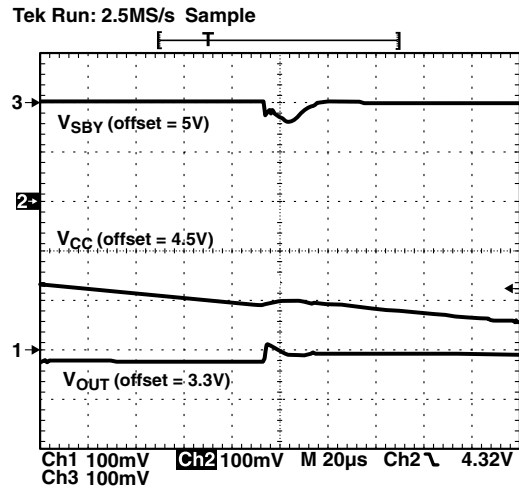

Figure 18.  $V_{CC}$  Power Down ( $V_{SBY} = 5V$ , Load = 300mA)

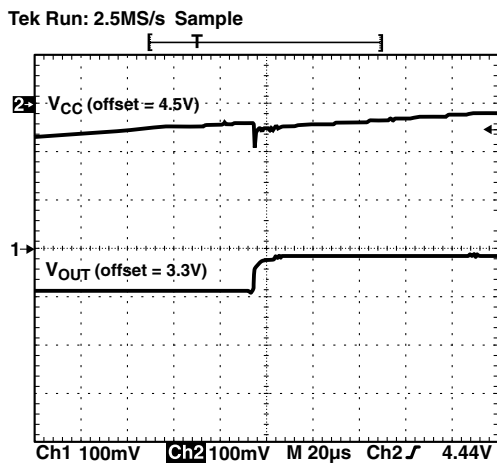

Figure 19.  $V_{CC}$  Power Up ( $V_{AUX} = 3.3V$ , Load = 300mA)

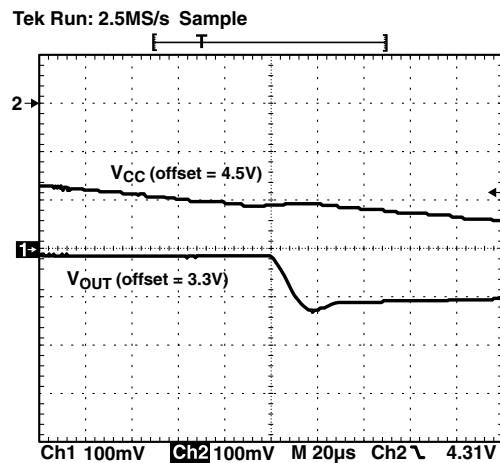

Figure 20.  $V_{CC}$  Power Down ( $V_{AUX} = 3.3V$ , Load = 300mA)

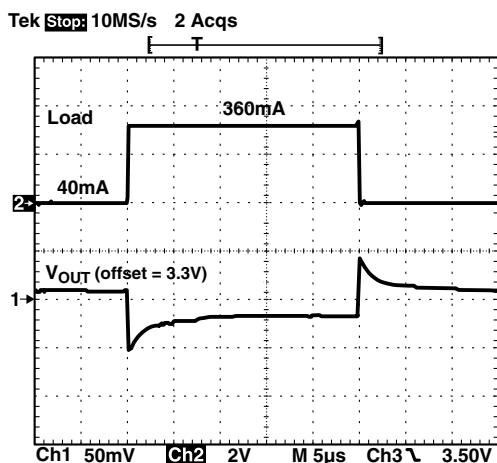

Figure 21. Load Transient Response (10% - 90% Rated)

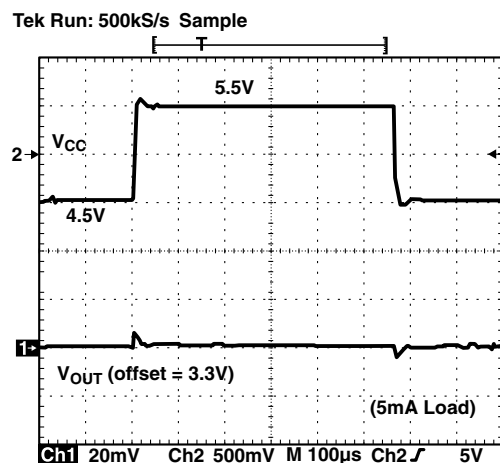

Figure 22. Line Transient ( $1V_{pp}$ ) Response

### Typical Thermal Characteristics

The overall junction to ambient thermal resistance ( $\theta_{JA}$ ) for device power dissipation ( $P_D$ ) consists primarily of two paths in series. The first path is the junction to the case ( $\theta_{JC}$ ) which is defined by the package style, and the second path is case to ambient ( $\theta_{CA}$ ) thermal resistance which is dependent on board layout. The final operating junction temperature for any set of conditions can be estimated by the following thermal equation:

$$T_{JUNC} = T_{AMB} + P_D (\theta_{JC}) + P_D (\theta_{CA})$$

$$= T_{AMB} + P_D (\theta_{JA})$$

The CMPWR330 uses a thermally enhanced package where all the GND pins (5 through 8) are integral to the leadframe. When this package is mounted on a double sided printed circuit board with two square inches of copper allocated for “heat spreading”, the resulting  $\theta_{JA}$  is 50°C/W.

Based on a maximum power dissipation of 0.7W (1.75V x 0.4A) with an ambient of 70°C the resulting junction temperature will be:

$$T_{JUNC} = T_{AMB} + P_D (\theta_{JA})$$

$$= 70^\circ\text{C} + 0.7\text{W} (50^\circ\text{C/W})$$

$$= 70^\circ\text{C} + 35^\circ\text{C} = 105^\circ\text{C}$$

Thermal characteristics were measured using a double sided board with two square inches of copper area connected to the GND pins for “heat spreading”.

Measurements showing performance up to junction temperature of 125°C were performed under light load conditions (5mA). This allows the ambient temperature to be representative of the internal junction temperature.

Note: The use of multi-layer board construction with separate ground and power planes will further enhance the overall thermal performance. In the event of no copper area being dedicated for heat spreading, a multi-layer board construction, using only the minimum size pad layout, will typically provide the CMPWR330 with an overall  $\theta_{JA}$  of 70°C/W which allows up to 780mW to be safely dissipated.

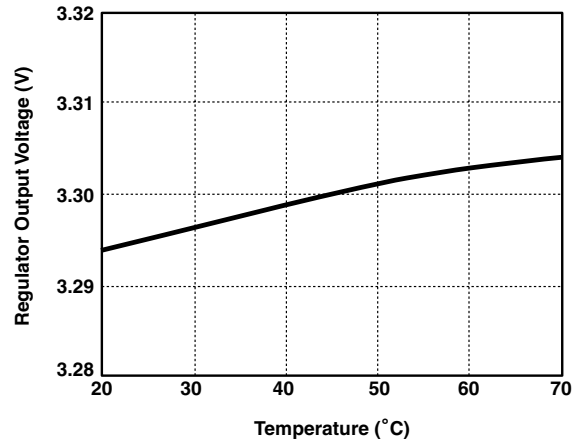

Figure 23.  $V_{OUT}$  Variation with  $T_{AMB}$  (400mA Load)<sub>T</sub>

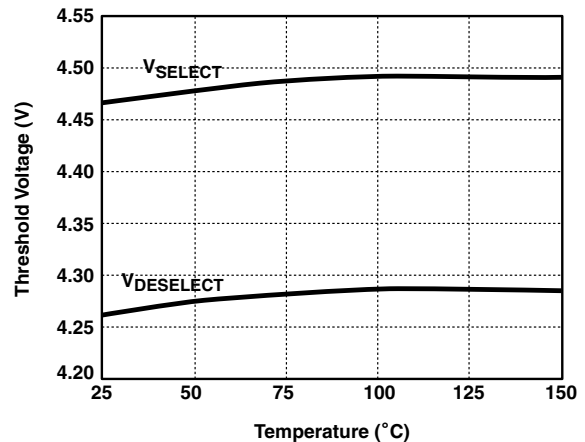

Figure 24. Select/Deselect Threshold Variation with  $T_{JUNC}$

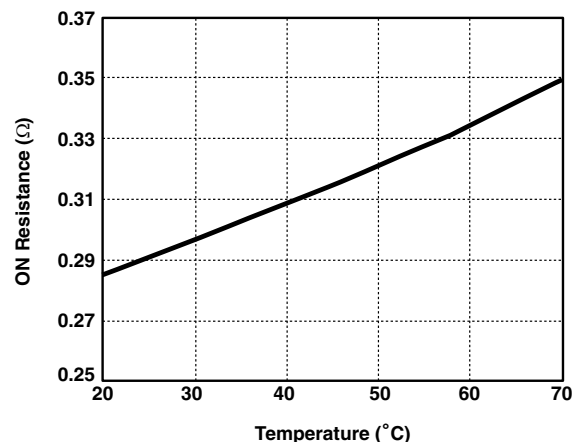

Figure 25.  $V_{AUX}$  Switch Resistance vs  $T_{AMB}$