

CXA1691BM/BS

FM/AM Radio

Description

CXA1691BM/BS is a one-chip FM/AM radio IC designed for radio-cassette tape recorders.

Features

- Small number of peripheral components.
- Low current consumption ($V_{CC}=3\text{ V}$)
 - For FM : $I_D=5.8\text{ mA}$ (Typ.)
 - For AM : $I_D=4.7\text{ mA}$ (Typ.)
- Built-in FM/AM select switch.
- Large output of AF amplifier.
 - $V_{CC}=6\text{ V}$, EIAJ output=500 mW (Typ.) when load impedance $8\ \Omega$

Function

FM section

- RF amplifier, Mixer and OSC (incorporating AFC variable capacitor).
- IF amplifier
- Quadrature detection
- Tuning LED driver

AM section

- RF amplifier, Mixer and OSC (with RF AGC)
- IF amplifier (with IF AGC)
- Detector
- Tuning LED driver

AF section

- Electronic volume control
- FM muting

Structure

Bipolar monolithic IC

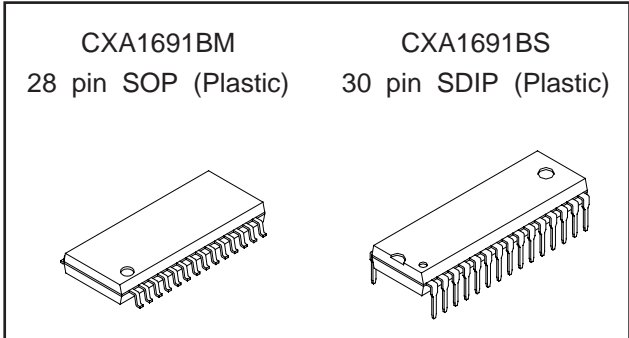

Absolute Maximum Ratings ($T_a=25\text{ }^\circ\text{C}$)

• Supply voltage	V_{CC}	14	V
• Operating temperature	T_{opr}	-10 to +60	$^\circ\text{C}$
• Storage temperature	T_{stg}	-50 to +125	$^\circ\text{C}$
• Allowable power dissipation	P_D	700	mW (CXA1691BM)
	P_D	1000	mW (CXA1691BS)

Recommended Operating Conditions

Supply voltage	V_{CC}	2 to 7.5	V (CXA1691BM)
	V_{CC}	2 to 8.5	V (CXA1691BS)

Sony reserves the right to change products and specifications without prior notice. This information does not convey any license by any implication or otherwise under any patents or other right. Application circuits shown, if any, are typical examples illustrating the operation of the devices. Sony cannot assume responsibility for any problems arising out of the use of these circuits.

Block Diagram

CXA1691BM

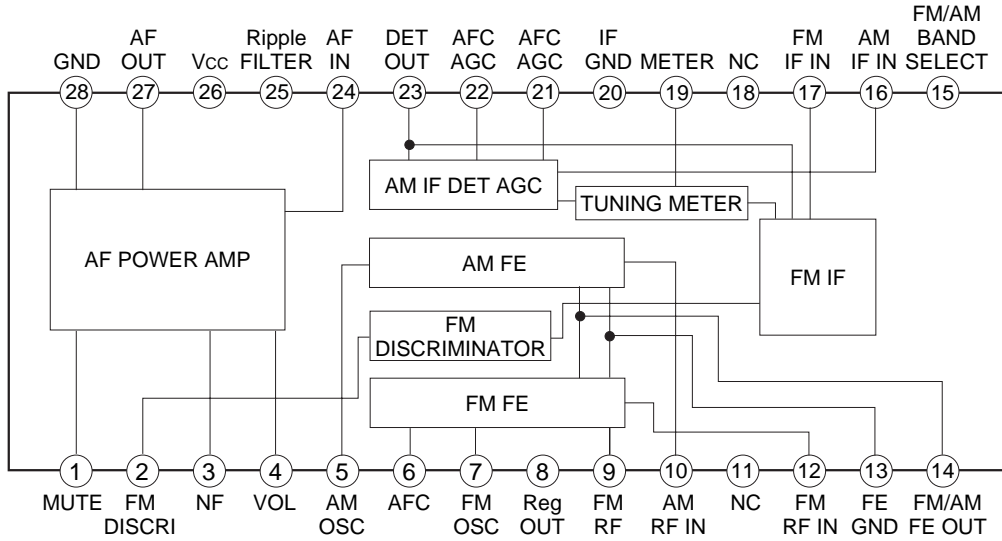

CXA1691BS

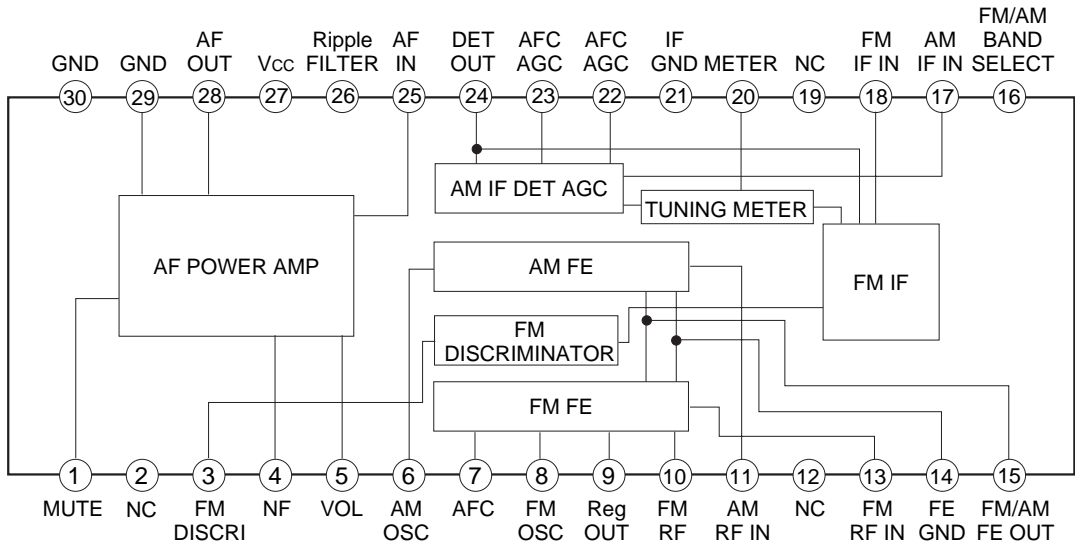

Standard Circuit Design Data

(The pin numbers in the parenthesis are for CXA1691BS.)

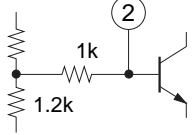
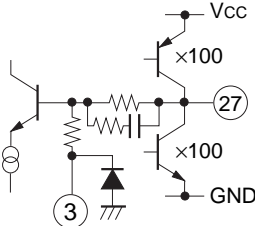
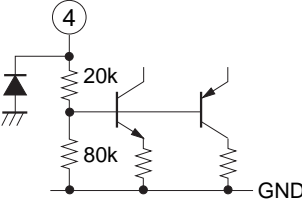
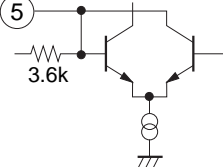
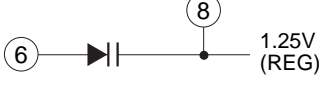
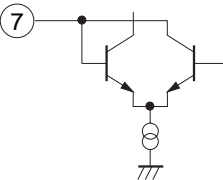
No.	Symbol	Voltage (V)				Equivalent circuit	Description
		Vcc=3 V		Vcc=6 V			
		FM	AM	FM	AM		
1 (1, 2)	MUTE	0	0	0	0		
2 (3)	FM DISCRI	2.18	2.70	4.88	5.43		Phase-shift circuit Connect ceramic discriminator
3 (4)	NF	1.5	1.5	3.0	3.0		Negative feedback pin
27 (28)	AF OUT	1.5	1.5	3.0	3.0		Power amplifier output pin
4 (5)	VOL CONT	1.25	1.25	1.25	1.25		Connect variable resistor for electronic volume control.
5 (6)	AM OSC	1.25	1.25	1.25	1.25		AM local oscillation circuit
6 (7)	AFC	1.25	*	1.25	*		AFC variable capacitor pin
8 (9)	REG OUT	1.25	1.25	1.25	1.25		Regulator pin 1.25 V (Typ.)
7 (8)	FM OSC	1.25	1.25	1.25	1.25		FM local oscillation circuit

No.	Symbol	Voltage (V)				Equivalent circuit	Description
		Vcc=3 V		Vcc=6 V			
		FM	AM	FM	AM		
9 (10)	FM RF	1.25	1.25	1.25	1.25		Connect FM RF tuning coil
12 (13)	FM RF IN	0.3	0	0.3	0		FM RF input pin
10 (11)	AM RF IN	1.25	1.25	1.25	1.25		AM RF input pin
11 (12)	NC	0	0	0	0		
13 (14)	GND (FE GND)	0	0	0	0		
14 (15)	FM/AM FE OUT	0.36	0.2	0.36	0.2		IF output pin of FM and AM. Connect IF filter.
15 (16)	BAND SELECT	0.84	0	0.88	0		FM and AM bands selection switch pin. During GND it becomes AM and during open it becomes FM.
16 (17)	AM IF IN	0	0	0	0		Input pin of AM IF.
17 (18)	FM IF IN	1.30	0	1.30	0		Input pin of FM IF.
18 (19)	NC	0	0	0	0		

No.	Symbol	Voltage (V)				Equivalent circuit	Description
		V _{CC} =3 V		V _{CC} =6 V			
		FM	AM	FM	AM		
19 (20)	METER	1.6	1.6	4.5	4.5		Meter drive circuit (For tuning indicator)
20 (21)	GND	0	0	0	0		
21 (22)	AFC/AGC	1.25	1.49	1.25	1.49		AFC pin of W band. During AM, it determines time constant of AGC
22 (23)	AFC/AGC	1.25	1.25	1.25	1.25		AFC pin of J band. During AM, it determines time constant of AGC.
23 (24)	DET OUT	1.25	1.0	1.25	1.0		Detection output pin
24 (25)	AF IN	0	0	0	0		Power amplifier input pin
25 (26)	RIPPLE FILTER	2.71	2.71	5.4	5.4		Ripple filter
26 (27)	V _{CC}	3.0	3.0	6.0	6.0		Power supply pin
28 (29, 30)	GND	0	0	0	0		Power GND

* The pin voltage of pin 6 during AM, it is the same pin voltage of pin 22 (23) during J BAND and is the same pin voltage of pin 21 (22) during W BAND.

(See the Electrical Characteristics Test Circuit, Ta=25 °C, Vcc=6 V)

Electrical Characteristics

No.	Item	Symbol	SW conditions						Test Point	Conditions	Min.	Typ.	Max.	Unit
			1	2	3	4	5	6						
1	AM circuit current	ID1	A	B	A	A	A	A	IA	No signal, AM	—	4.8	10.0	mA
2	FM circuit current	ID2	A	B	A	A	B	A	IA	No signal, FM	—	7.6	14.0	mA
3	FM front end voltage gain	GV1	A	B	A	A	B	A	VA	V _{IN1} =40 dBμV, 100 MHz	32	39	46	dB
4	FM detection output level	VD1	A	—	—	A	B	A	VD	V _{IN3} =90 dBμV, 10.7 MHz (1 kHz, 22.5 kHz DEV)	39	77.5	155	mVrms
5	FM IF knee level	VD2	A	—	—	A	B	A	VD	V _{IN3} =level at a point 3 dB down from V _{IN3} =90 dBμV, 10.7 MHz (1 kHz, 22.5 kHz DEV)	—	24	32	dBμV
6	FM detection output distortion factor	THD1	A	—	—	A	B	A	VD	V _{IN3} =90 dBμV, 10.7 MHz (1 kHz, 75 kHz DEV)	—	0.3	2.0	%
7	FM meter current	IB1	A	—	—	A	B	A	IM	V _{IN3} =60 dBμV, 10.7 MHz	1.8	3.5	7.0	mA
8	AM front end voltage gain	GV2	A	A	A	A	A	A	VB	V _{IN2} =60 dBμV, 1660 kHz	15	22	29	dB
9	AM IF voltage gain	GV3	A	A	—	A	A	A	VD	V _{IN3} when 455 kHz (1 kHz, 30 % MOD) output is -34 dBm	14	20	27	dBμV
10	AM detection output level	VD3	A	A	—	A	A	A	VD	V _{IN3} =85 dBμV, 455 kHz (1 kHz, 30 % MOD)	39	77.5	155	mVrms
11	AM meter current	IB2	A	A	—	A	A	A	IM	V _{IN3} =85 dBμV, 455 kHz (1 kHz, 30 % MOD)	1.3	3.0	7.0	mA
12	AM detection output distortion factor	THD2	A	A	B	A	A	A	VD	V _{IN2} =95 dBμV, 1660 kHz (1 kHz, 30 % MOD)	—	0.6	2.0	%
13	Audio voltage gain	GV4	A	—	—	—	—	B	VE	V _{IN3} =60 dBμV, 10.7 MHz V _{IN4} =-30 dBm, 1 kHz	27	31.5	36	dB
14	Audio distortion factor	THD3	A	—	—	—	—	B	VE	Distortion factor for 50 mW output V _{IN3} =60 dBμV, 10.7 MHz V _{IN4} =-20 dBm, 1 kHz	—	0.9	2.5	%
15	Muting level	VD4	A	—	—	—	—	B	VE	Muting level for 50 mW output V _{IN4} =-20dBm, 1 kHz Attenuation for 60 dBμV input with V _{IN3} OFF	8	15	22	dB

0 dBμV=1 μV



Electrical Characteristics Test Circuit

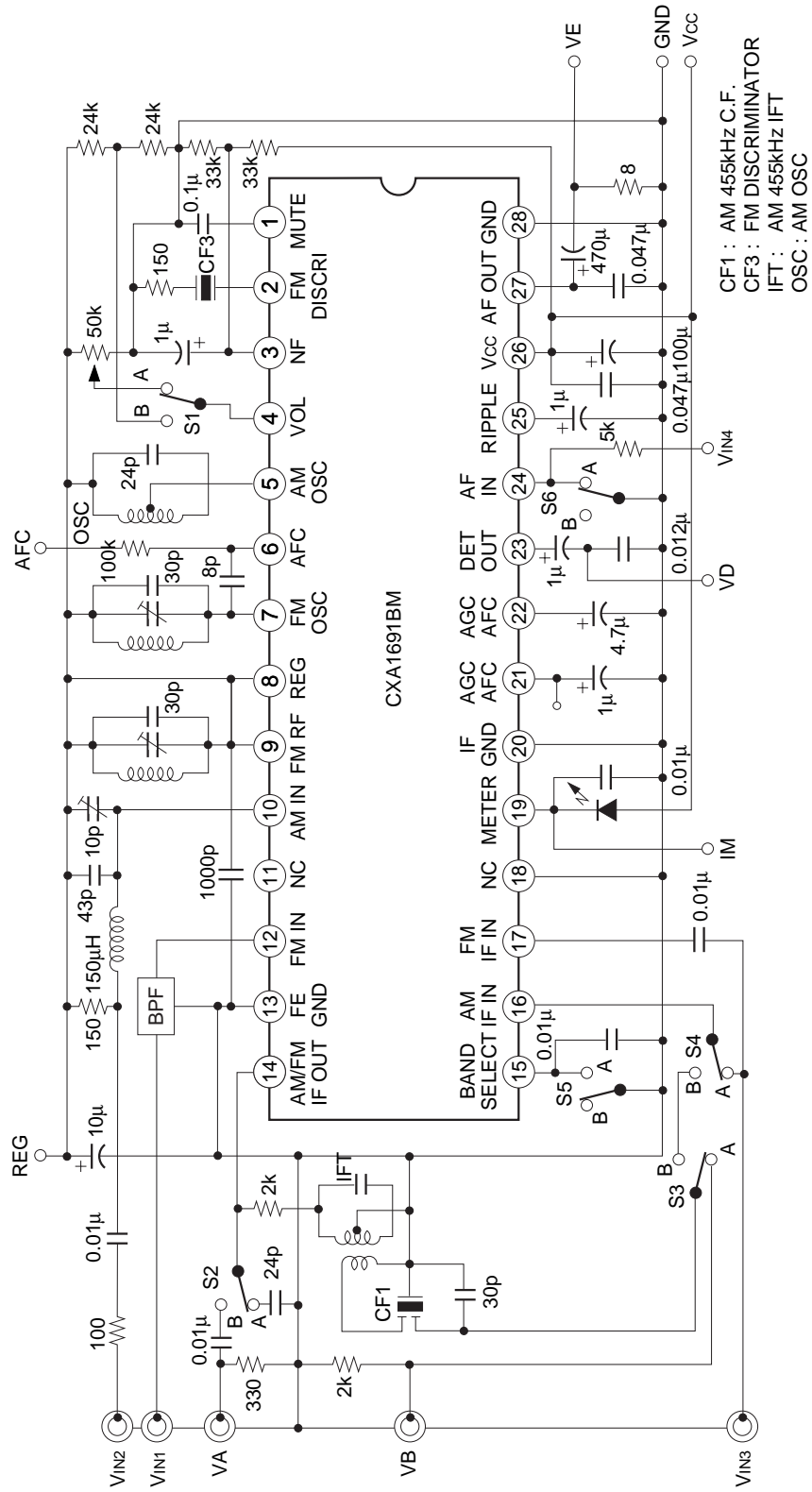

Application Circuit 1

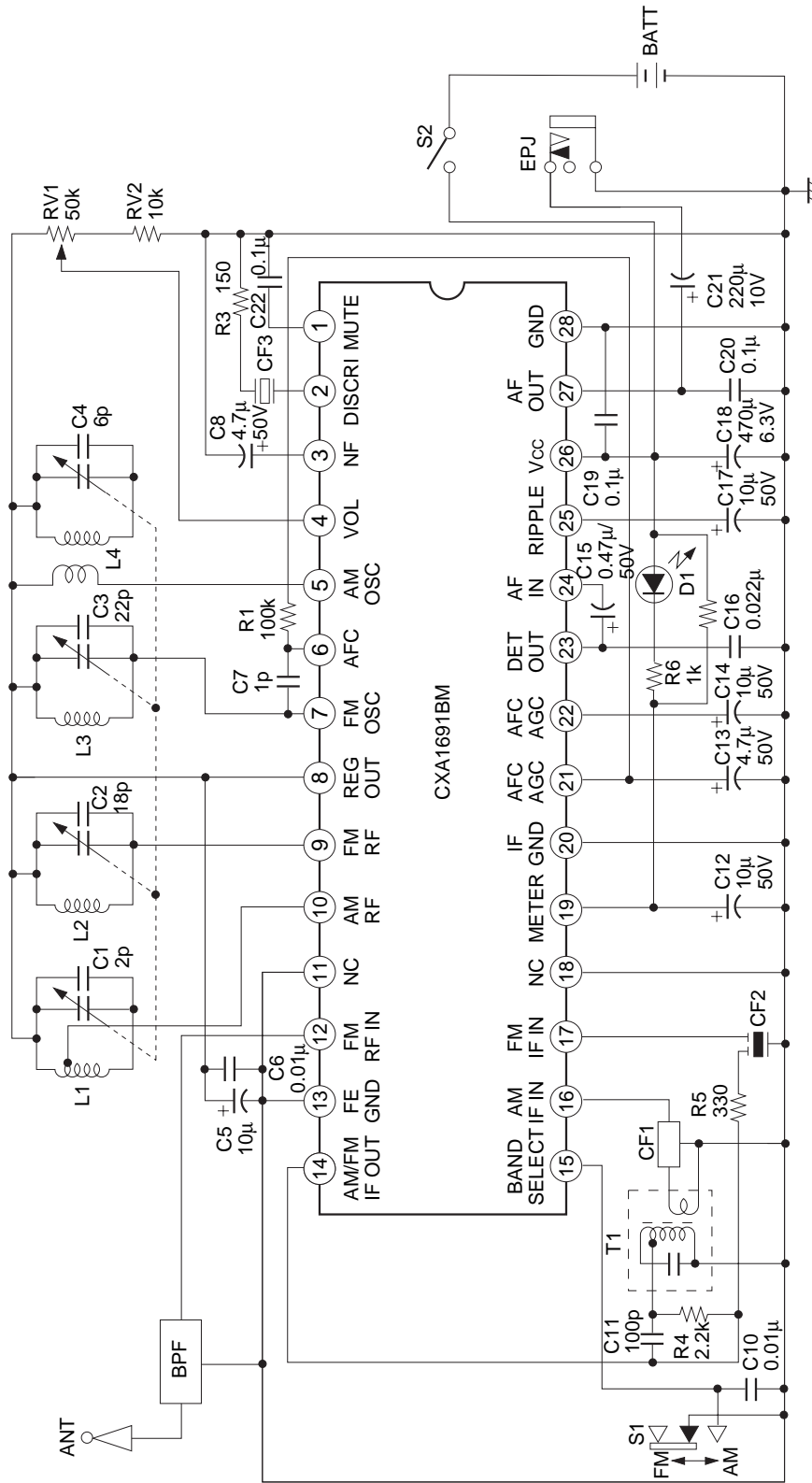

Application circuits shown are typical examples illustrating the operation of the devices. Sony cannot assume responsibility for any problems arising out of the use of these circuits or for any infringement of third party patent and other right due to same.

Coil data

AM OSC

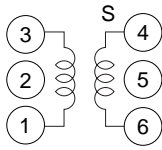

Core diameter ϕ 0.06 mm 2UEW

f (kHz)	L (μ H)	Qo	Number of windings (t)	
			1 to 3	4 to 6
796	270	125	107	29

Equivalent to L-5K7-H5 R12-1684X. Mitsumi Electric Co., Ltd.
or 7TRS-8441X TOKO Co., Ltd.

AM IFT

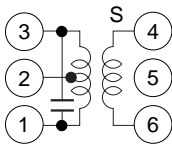

Core diameter ϕ 0.07 mm UEW

Co (pF)	Qo	Number of windings (t)		
		1 to 2	2 to 3	4 to 6
180	90	111	35	7

Equivalent to 21K7-H5 R12-8558A. Mitsumi Electric Co., Ltd.
or 7MC-7789N TOKO Co., Ltd.

FM RF

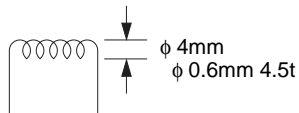

FM OSC

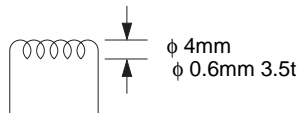

AM bar antenna

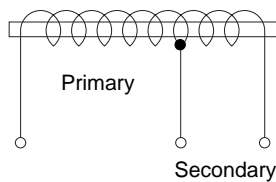

f (kHz)	L (μ H)	Primary	Secondary
796	650	91 t	20 t

BPF PFW8
(88 to 108 MHz) Soshin Electric Co., Ltd.

CF1 SFU-455B Murata Mfg. Co., Ltd. Or BFCFL-455 TOKO Co., Ltd.

CF2 SFE10.7MA5 Murata Mfg. Co., Ltd.

CF3 CDA10.7MC1 Murata Mfg. Co., Ltd.

Package Outline Unit : mm

CXA1691BM

28PIN SOP (PLASTIC)

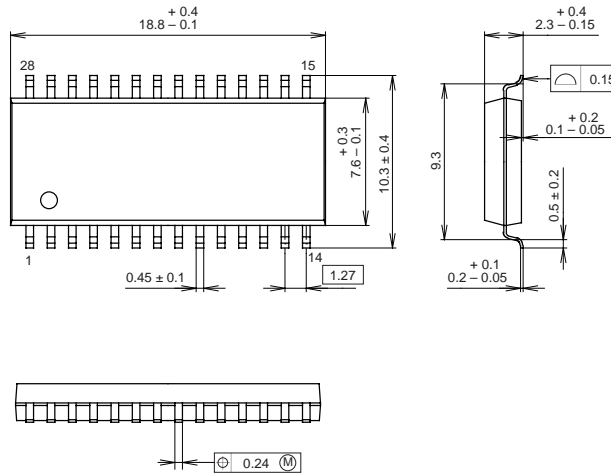

PACKAGE STRUCTURE

SONY CODE	SOP-28P-L04
EIAJ CODE	SOP028-P-0375
JEDEC CODE	—

PACKAGE MATERIAL	EPOXY RESIN
LEAD TREATMENT	SOLDER PLATING
LEAD MATERIAL	42/COPPER ALLOY
PACKAGE MASS	0.7g

CXA1691BS

30PIN SDIP (PLASTIC)

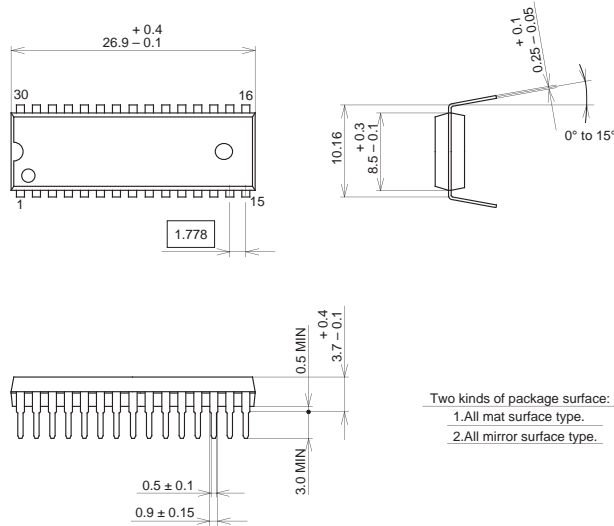

Two kinds of package surface:
 1.All mat surface type.
 2.All mirror surface type.

PACKAGE STRUCTURE

SONY CODE	SDIP-30P-01
EIAJ CODE	SDIP030-P-0400
JEDEC CODE	—

MOLDING COMPOUND	EPOXY RESIN
LEAD TREATMENT	SOLDER/PALLADIUM PLATING
LEAD MATERIAL	COPPER ALLOY
PACKAGE MASS	1.8g

NOTE : PALLADIUM PLATING
 This product uses S-PdPPF (Sony Spec.-Palladium Pre-Plated Lead Frame).