

LZ93N61

Timing Pulse Generator LSI for CCD

DESCRIPTION

The LZ93N61 is a CMOS timing generator LSI which provides timing pulses used to drive a CCD area sensor, in combination with the SSG LSI (LZ93NI 9, LZ93B53).

FEATURES

- Switchable between 270000 pixels CCD and 320000 pixels CCD
- Switchable between NTSC (EIA) and PAL (CCIR) systems
- Internal electronic shutter :
Shutter speed is selectable from 1/W, 1/125, 1/250, 1/500, 1/1 000, 1/2 000, 1/4 000 and 1/10 000 s, in addition to this, 1/100 s (PAL : 1/120 s) in Flicker-less mode using parallel or serial code. Shutter speed can also be controlled in 1 H period using an external trigger to the EXST input.
- Single +5 V power supply
- Package : 48-pin QFP(QFP048-P-101 O)

PIN CONNECTIONS

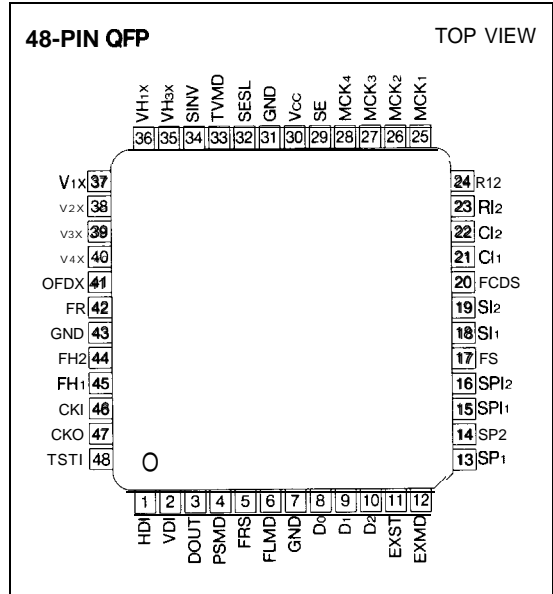

BLOCK DIAGRAM

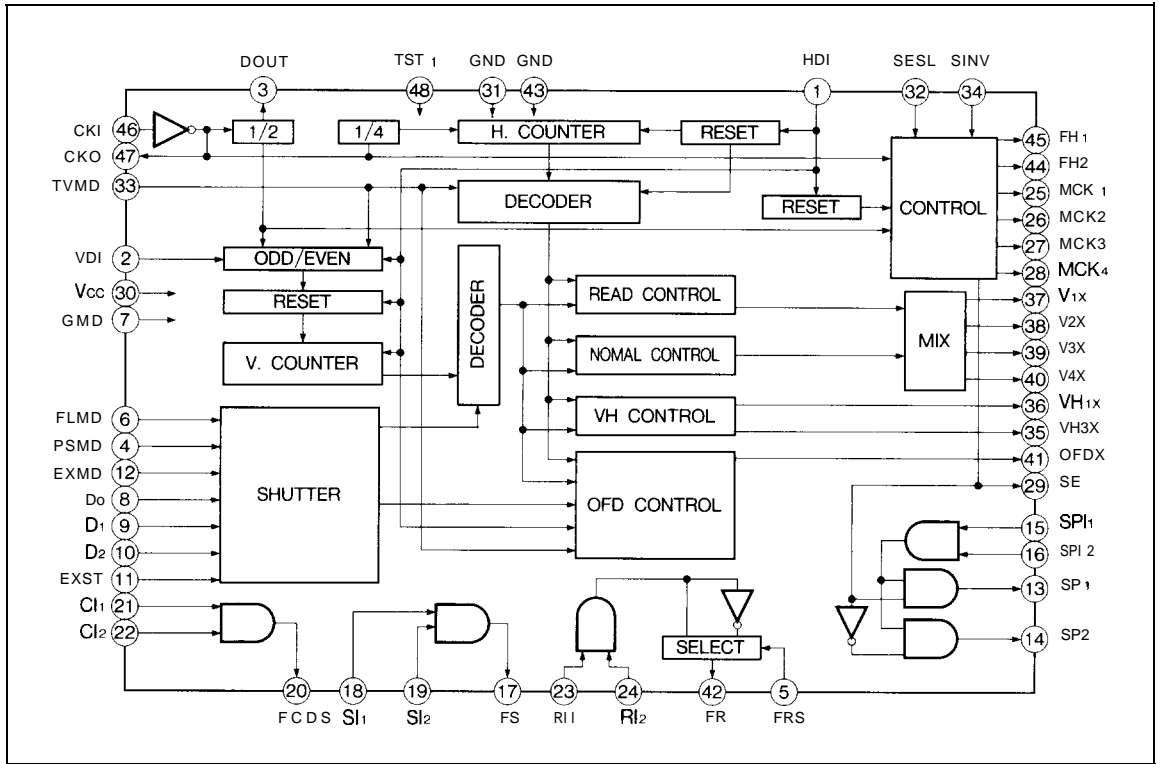

ABSOLUTE MAXIMUM RATINGS

PARAMETER	SYMBOL	RATING	UNIT
Supply voltage	V _{CC}	- 0.3 to + 7.0	v
Input voltage	V _I	-0.3 to V _{CC} + 0.3	v
Output voltage	V _O	- 0.3 to V _{CC} + 0.3	v
Operating temperature	T _{opr}	-20 to +70	°C
Storage temperature	T _{stg}	-55 to +150	°C

DC CHARACTERISTICS





(V_{CC} = 5 V ± 10%, T_a = -10 to +70°C)















PARAMETER	SYMBOL	CONDITIONS	MIN.	TYP.	MAX.	UNIT	NOTE
Input Low voltage	V _{IL}				1.5	v	1
Input High voltage	V _{IH}		3.5			v	
Input High threshold voltage	V _{T+}		2.2		3.8	v	2
Input Low threshold voltage	V _{T-}		1.0		2.4	v	
Hysteresis voltage	V _{T+} - V _{T-}		0.4			v	
Output Low voltage	V _{OL1}	I _{OL} = 4 mA			0.4	v	3
Output High voltage	V _{OH1}	I _{OH} = -2 mA	4.0			v	
Output Low voltage	V _{OL2}	I _{OL} = 8 mA			0.4	v	4
Output High voltage	V _{OH2}	I _{OH} = -4 mA	4.0			v	
Output Low voltage	V _{OL3}	I _{OL} = 16 mA			0.4	v	5
Output High voltage	V _{OH3}	I _{OH} = -10 mA	4.0			v	
Input Low current	I _{IL1}	V _I = 0 v			1.0	μA	6
	I _{IL2}	V _I = 0 v	8.0		60	μA	7
Input High current	I _{IH1}	V _I = V _{CC}			1.0	μA	8
	I _{IH2}	V _I = V _{CC}	8.0		60	μA	9











NOTES :

1. Applied to all inputs except for VDI, CKI.
2. Applied to input (VDI).
3. Applied to all outputs except for CKO.
4. Applied to outputs (FR, MCK₁, MCK₂, MCK₃, MCK₄).
5. Applied to outputs (FH₁, FH₂).
6. Applied to all inputs except for PSMD, FRS, FLMD, Do, D₁, D₂, EXST, SESL, SINV
7. Applied to inputs (PSMD, FRS, FLMD, Do, D₁, D₂, EXST, SESL, StNV).
8. Applied to all inputs except for EXMD, TVMD, TST₁.
9. Applied to inputs (EXMD, TVMD, TST₁).

PIN FUCTION

PIN NO.	SYMBOL	I/O	POLARITY	PIN NAME	FUNCTION
1	HDI	IC	MM	Horizontal drive pulse	The HDI pin is used to input the horizontal reference signal from SSG. It is connected to the HD (pin 31) of the LZ93N19.
2	VDI	ICS		Vertical drive pulse	The VDI pin is used to input the vertical reference signal from SSG. It is connected to the VD (pin 34) of the LZ93N19.
3	DOUT	o		Delay-Line clock	The DOUT pin output 1/2 dividing clock input to the CKI (pin 46). It is connected to the CLKI (pin 27) of the LZ93N19.
4	PSMD	ICU	—	Shutter mode select input	The PSMD pin is used to switch the Shutter Speed Setting mode. High level : Parallel Setting mode Low level : Serial Setting mode (Refer to "SHUTTER MODE TABLE".)
5	FRS	ICU	—	FR control input	The FRS pin is used to selects the polarity of the FR (pin 42). High level : negative polarity Low level : positive polarity
6	FLMD	ICU	—	Flicker-less mode select	The FLMD pin is used to prevent the flicker. (Refer to "SHUTTER MODE TABLE".)
7	GND	—	—	Ground	The GND is a ground pin.
6	Do	Icu	—	Shutter speed switching input 0	The Do pin is used to control the shutter speed. (Refer to "SHUTTER MODE TABLE".)
9	D1	ICU	—	Shutter speed switching input 1	The D1 pin is used to control the shutter speed. (Refer to "SHUTTER MODE TABLE".)
10	D2	ICU	—	Shutter speed switching input 2	The D2 pin is used to control the shutter speed. (Refer to "SHUTTER MODE TABLE".)
11	EXST	ICU	—	Shutter speed control 1	The EXST pin used to control the shutter speed 1 H by 1 H. (Refer to "SHUTTER MODE TABLE",)
12	EXMD	ICU	—	Shutter speed control 2	When the EXMD input pin is Low level, the EXST (pin 11) is prohibited. (Refer to "SHUTTER MODE TABLE".)
13	SP1	o		Color sampling pulse 1	The SPI pin output the sampling pulse for color demodulation based upon the output signal of CCD. It outputs at High level of the SE (pin 29).
14	SP2	o		Color sampling pulse 2	The SP2 pin output the sampling pulse for color demodulation based upon the output signal of CCD. It outputs at Low level of the SE (pin 29).

PIN NO.	SYMBOL	I/O	POLARITY	PIN NAME	FUNCTION
15	SPI ₁	IC		SPI and SP2 phase control input 1	The SPI ₁ pin sets the falling edge of color sampling pulses SP ₁ (pin 13) and SP ₂ (pin 14).
16	SP12	IC		SP ₁ and SP ₂ phase control input 2	The SP12 pin sets the rising edge of color sampling pulses SPI (pin 13) and SP2 (pin 14).
17	FS	o		CDS pulse 2	The FS pin outputs the pulses for sampling output signals of CCD.
18	SI ₁	IC		FS phase control input 1	The SI ₁ pin sets the phase of the FS (pin 17).
19	SI ₂	IC		FS phase control input 2	The SI ₂ pin sets the width of the FS (pin 17).
20	FCDS	o		FCDS pulse 1	The FCDS pin outputs the pulse to clamp the output signals of CCD.
21	CI ₁	IC		FCDS phase control input 1	The CI ₁ pin sets the phase of the FCDS (pin 20).
22	CI ₂	IC		FCDS phase control input 2	The CI ₂ pin sets the width of the FCDS (pin 20).
23	RI ₁	IC		FR phase control input 1	The RI ₁ pin sets the phase of the FR (pin 42).
24	RI ₂	IC		FR phase control input 2	The RI ₂ pin sets the width of the FR (pin 42).
25	MCK1	o		Clock output 1	The MCK1 pin outputs 1/2 dividing pulse of CKI (pin 46). It is the same phase with the FH ₁ (pin 45).
26	MCK2	o		Clock output 2	The MCK2 pin outputs 1/2 dividing pulse of CKI (pin 46). It is delayed by approximately 90° in phase with respect to FH ₁ (pin 45).
27	MCK3	o		Clock output 3	The MCK3 pin outputs 1/2 dividing pulse of CKI (pin 46). It is the same phase with the FH ₂ (pin 44).
28	MCK4	o		Clock output 4	The MCK4 pin outputs 1/2 dividing pulse of CKI (pin 46). It is delayed by approximately 90° in phase with respect to FH ₂ (pin 44).
29	SE	o		Color demodulation pulse	The SE pin outputs the demodulation carrier of output signals of CCD, and input the switching signal of color sampling pulses SP ₁ (pin 13) and SP ₂ (pin 14). It outputs 1/4 dividing pulse of the CKI input (pin 46), and selects the phase in combination with the SESL (pin 32) and the SINV (pin 34).
30	V _{CC}	-	-	Power supply	The V _{CC} is a + 5 V power supply pin.
31	GND	-	-	Ground	The GND is a ground pin.

PIN NO.	SYMBOL	I/O	POLARITY	PIN NAME	FUNCTION
32	SESL	ICU	-	SF control input	The SESL input pin selects the phase of color demodulation carrier output SE (pin 29). Low level : synchronized with the rising edge of FH ₁ (pin 45). High level : synchronized with the rising edge of FH ₂ (pin 44).
33	TVMD	ICD	-	TV mode input	The TVMD input pin selects the TV system. Low level : NTSC system High level : PAL system
34	SINV	ICU	-	Color line input	The SINV input pin is used to invert the color demodulation carrier output SE (pin 29) at 1 H rate.
35	VH3X	0		Read out pulse 3	The VH3X is a pulse output pin to transfer the photodiode charge of CCD to the vertical shift register. It is connected to the 3BX (pin 11) of the LR366B3N vertical driver LSI.
36	VH1x	0		Read out pulse 1	The VH1x is a pulse output pin to transfer the photodiode charge of CCD to the vertical shift register. It is connected to the 1 BX (pin 8) of the LR366B3N vertical driver LSI.
37	V1x	o		Vertical transfer pulse 1	The V1x , V2X , V3X and V4X are transfer pulse output pins for CCD vertical shift register,
38	V2X	o		Vertical transfer pulse 2	
39	V3X	o		Vertical transfer pulse 3	
40	V4X	o		Vertical transfer pulse 4	
41	OFDX	o		OFD pulse output	The OFDX pin is used to output for controlling OFD voltage during electronic shutter operation.
42	FR	02		Reset pulse	The FR pin outputs the reset pulse of CCD. It is connected to the ϕ_R through the offset circuit.
43	GND	-	-	Ground	The GND is a ground pin.
44	FH2	05		Horizontal transfer pulse 2	The FH2 pin outputs the horizontal transfer pulse of CCD shift register. It is connected to the ϕ_{H2} .
45	FH1	05		Horizontal transfer pulse 1	The FH1 pin outputs the horizontal transfer pulse of CCD shift register, It is connected to the ϕ_{H1} .
46	CKI	ICK		Clock input	The CKI is a reference clock input pin of horizontal and vertical pulses, Frequency for NTSC (TVMD = L) 1212 fH : CCD of 542 horizontal pixels. Frequency for PAL (TVMD = H) 1236 fH : CCD of 542 horizontal pixels. (fH = Horizontal frequency)

PIN NO.	SYMBOL	I/O	POLARITY	PIN NAME	FUNCTION
47	CKO	OCK		Clock output	The CKO pin outputs clocks at the reverse of the CKI (pin 46).
48	TST1	ICD	-	Test terminal 1	The TST ₁ input pin is normally kept Low or open.

IC : Input pin (CMOS level).

ICU : Input pin (CMOS level with built-in pull-up resistor).

ICD : Input pin (CMOS level with built-in pull-down resistor).

ICS : Input pin (CMOS level schmitt).

ICK : Input pin for oscillation.

OCK : Output pin for oscillation.

0 : Output pin.

02 : Output pin.

05 : Output pin.

SUPPLEMENTARY EXPLANATION

SHUTTER MODE TABLE

PIN	INPUT PIN								REGISTER IN LSI								SHUTTER SPEED (s)	NOTE
	PS MD	FL MD	TV MD	EX MD	EX ST	“2	“	Do	D ₇	D ₆	D ₅	D ₄	D ₃	D ₂	D ₁	D ₀		
PARALLEL	H	H		L		L	L	L									NORMAL	1
	H	H		L		L	L	H									1/125	
	H	H		L		L	H	L									1/250	
	H	H		L		L	H	H									1/500	
	H	H		L		H	L	L									1/1 000	
	H	H		L		H	L	H									1/2 000	
	H	H		L		H	H	L									1/4 000	
	H	H		L		H	H	H									1/10000	
	H	L	L	L													1/100	
	H	L	H	L													1/120	
SERIAL	L	H		L						H		H	L	L	L		NORMAL	1
	L	H		L						H		H	L	L	H		1/125	
	L	H		L						H		H	L	H	L		1/250	
	L	H		L						H		H	L	H	H		1/500	
	L	H		L						H		H	H	L	L		1/1 000	
	L	H		L						H		H	H	L	H		1/2 000	
	L	H		L						H		H	H	H	L		1/4 000	
	L	H		L						H		H	H	H	H		1/10000	
	L	H	H	L						H	H	L					1/100	
	L	H	H	L						H	L	L					1/120	
	L	H	L	L						H	H	L					1/100	
	L	H	L	L						H	L	L					1/120	
	L	H		L						L							OFDX = H	
L	L	L	L													1/100		
L	L	H	L													1/120		
																	OFDX = H	2
			H	1													EXST	3

NOTES :

1. NTSC=1/60 s, PAL=1/50 s.
2. The data of shutter speed was decided by the control pulse EXST (pin 11), is deleted.
3. The shutter speed is decided by the falling edge of control pulse EXST (pin 11).
4. The data of shutter speed was decided by the control pulse EXST (pin 11), hold as it is

INITIAL STATUS IN SERIAL MODE AND EXTERNAL TRIGGER MODE

When power is turned on in Serial mode (PSMD = L) or External Trigger mode (EXMD = H), the mode is not established until data is input from serial code or EXST.

SERIAL DATA FORMAT

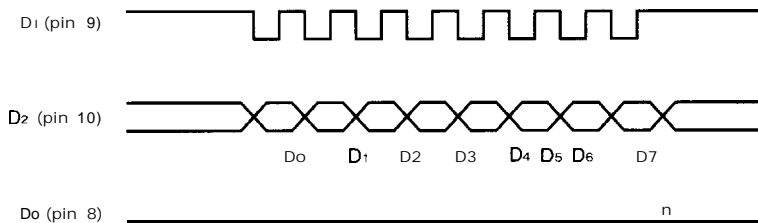

NOTE :

D₀-D₇ are latched by the rising edge of pulse D₁ (pin 9).
By the falling edge of pulse Do (pin 8), the shutter speed is decided.

DESCRIPTION OF EXTERNAL SYNCHRONOUS SHUTTER MODE

1. When EXMD = H, this mode is given priority over other modes. On applying falling edge of trigger input to EXST (pin 11), the IC reads at the rising edge of HDI and latches the V period counter value, and controls final output of the OFDX pulse during this H period. (The pulse must last until HDI goes high.)
2. Once latched, the value of V period counter is retained until the next trigger is input as long as EXMD = H, even trigger input is for odd (ODD) or even (EVEN) field, the storage time of another field becomes the same as the field with trigger input automatically.

Note that when changing in high speed shutter direction, the internally stored data is used first, This causes the delay to control by one field.

[Trigger input disabled range]

To match ODD storage time with EVEN storage time, the pulse start position is set at 20/283 H for NTSC and 22/335 H for PAL. This means that inputting the trigger at 18/280, 281 H in NTSC mode and 20/332, 333 H in PAL mode is made disabled.

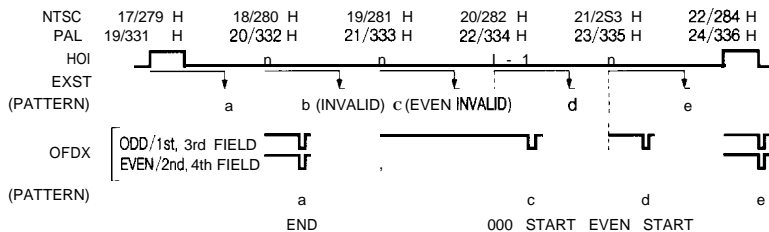

TIMING DAIGRAM

VERTICAL PULSE TIMING < NTSC >

Shutter speed
1/10000 s

(ODD FIELD)

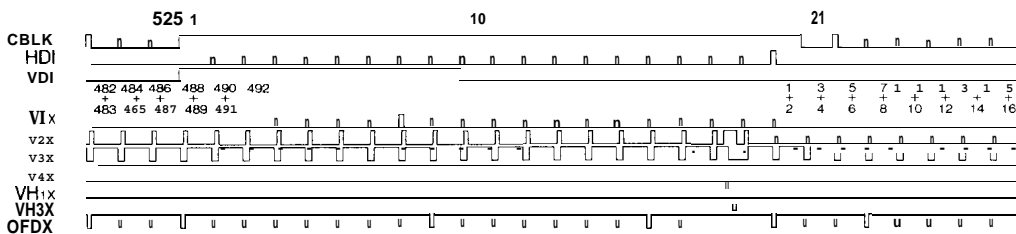

(EVEN FIELD)

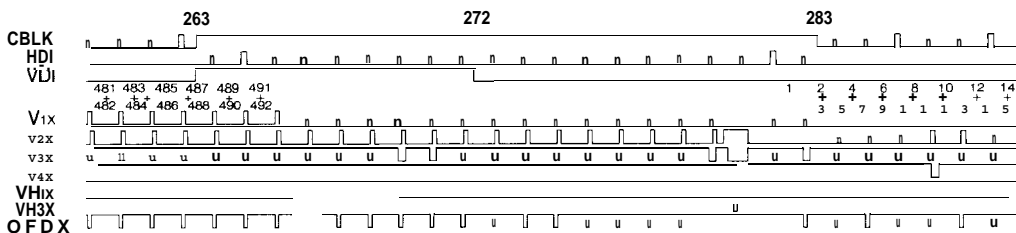

VERTICAL PULSE TIMING < PAL >

Shutter speed
1/10000 s

(1 St, 3rd FIELD)

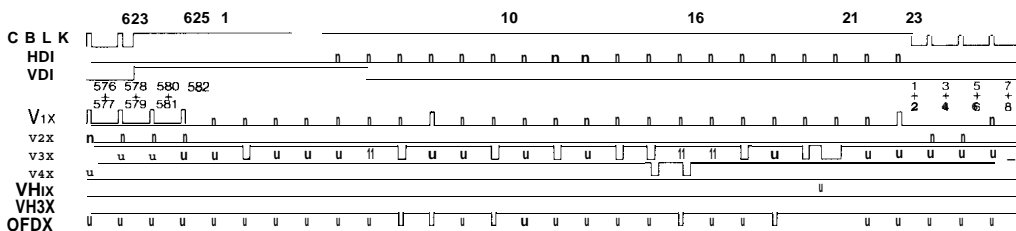

(2nd, 4th FIELD)

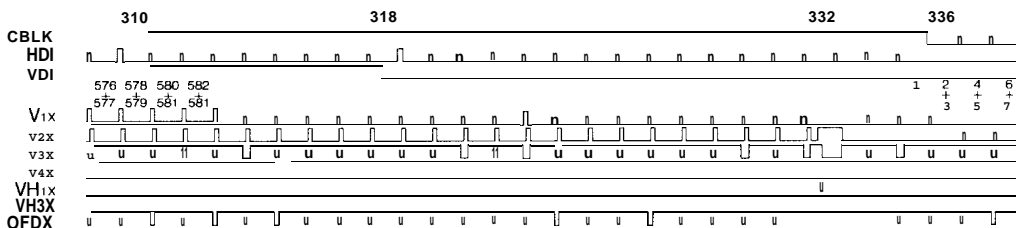

CHARGE READ TIMING < NTSC >

(ODD FIELD)

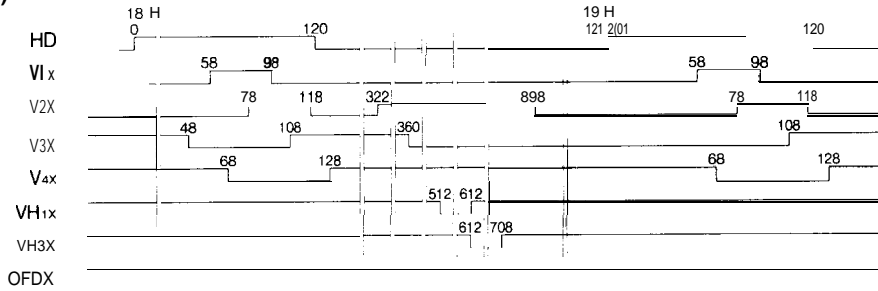

(EVEN FIELD)

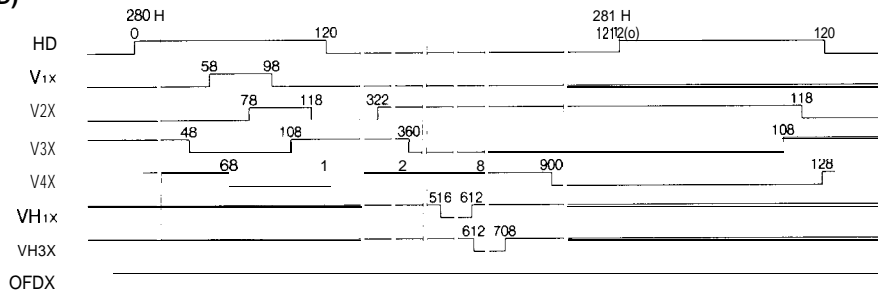

CHARGE READ TIMING < PAL >

(1st, 3rd FIELD)

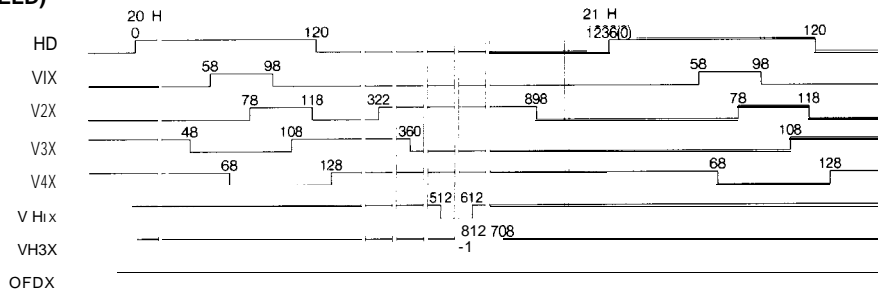

(2nd, 4th FIELD)

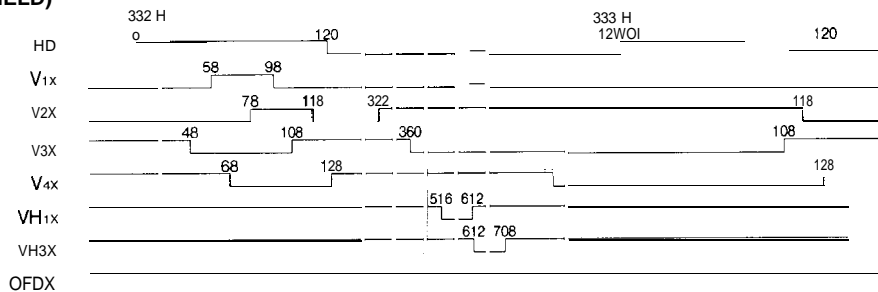

HORIZONTAL PULSE TIMING

