

VIDEO SUPER IMPOSER WITH AFC

GENERAL DESCRIPTION

The NJM2217 has functions of character and background superimposition to video signal and consists of synchronous separation circuit, vertical synchronous reproducing circuit, video switch and AFC circuit. Built-in AFC circuit makes the NJM2217 stable to noise and disorder of synchronous signal and takes off character disorder on Display Broun tube.

PACKAGE OUTLINE

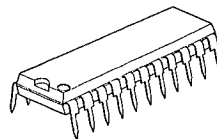

NJM2217L

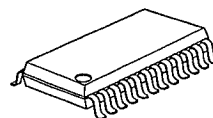

NJM2217M

FEATURES

- Operating Voltage (+4V~+6V)
- 2 video signal input terminals
- Internal synchronous separation Circuit and internal horizontal synchronous reproduce circuit. Can make trigger signal to character generator.
- Stable horizontal synchronous signal by build-in AFC circuit.
- Package Outline SDIP22, DMP24
- Bipolar Technology

RECOMMENDED OPERATING CONDITION

- Operating Voltage: 4V~6V

APPLICATION

- VCR, Video Camera, Other Video Equipment

BLOCK DIAGRAM

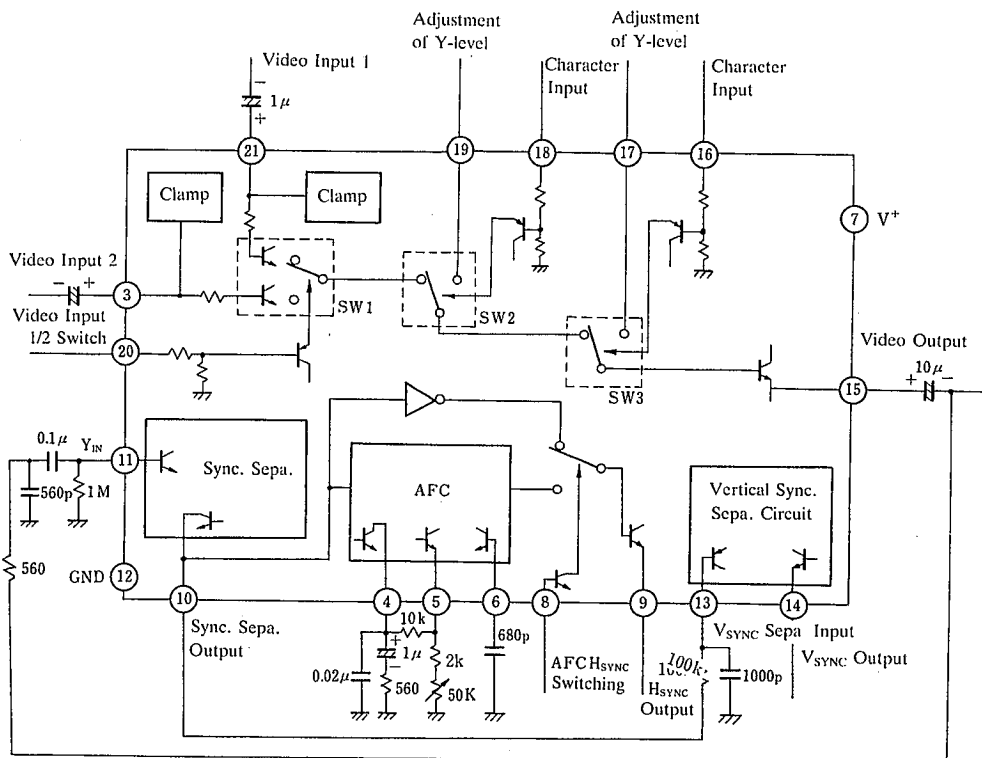

■ ABSOLUTE MAXIMUM RATINGS

(Ta=25°C)

PARAMETER	SYMBOL	RATINGS	UNIT
Supply Voltage	V ⁺	7	V
Power Dissipation	P _D	(SDIP22) 700 (DMP24) 700	mW
Operating Temperature Range	T _{opr}	-20 ~ +75	°C
Storage Temperature Range	T _{stg}	-40 ~ +125	°C

■ ELECTRICAL CHARACTERISTICS

PARAMETER	SYMBOL	TEST CONDITION	MIN.	TYP.	MAX.	UNIT
Operating Current	I _{CC}	No signal	—	20	26	mA
Offset Voltage of Luminance Control	V _{OS}	Ex. 10kΩ, Voltage difference between both terminals of resistor at 2.5V supply voltage 19 Pin, 17 Pin	—	—	0.1	V
Control Terminal Threshold	V _{TH}	16 Pin, 18 Pin, 20 Pin	0.4	1.4	2.0	V
Gain	G _V	10 STEP Stair wave 2.2V _{p-p} R _L =5k	-1	0	+1	dB
Frequency Characteristic	G _F	DC~5MHz 2V _{p-p} R _L =5k	-1	0	+1	dB
Cross-Talk	CT	3.58MHz 2V _{p-p} One side 75Ω terminal	—	50	—	dB
Horizontal Sync. Output High	V _{IHH}	R _L =2k	3.5	4.0	—	V
Horizontal Sync. Output Low	V _{IHL}	R _L =2k	—	0	0.1	V
Vertical Sync. Output High	V _{VH}	R _L =2k	3.5	4.0	—	V
Vertical Sync. Output Low	V _{VL}	R _L =2k	—	0	0.1	V
Free-Run Frequency	f _O	Pin 10=GND	14.5	—	17.0	kHz
Lock Range	f _L	(Note 1)	1.5	2.5	—	kHz
Capture Range	f _C	(Note 1)	0.6	1.3	—	kHz
AFC Output Pulse Width	P _W	Pin 8=5V Lock state	3.5	5.0	6.5	μs
AFC Output Delay	P _D	(Note 2)	-1.5	0	1.5	μs
Schmitt Trigger Threshold High	V _{TH}	Rise of Vertical Sync. Signal	1.9	2.1	2.3	V
Schmitt Trigger Threshold Low	V _{TL}	Fall of Vertical Sync. Signal	1.1	1.3	1.5	V
Differential Gain	DG	10 STEP Stair wave 2.2V _{p-p} R _L =5k	—	0.5	3.0	%
Differential Phase	DP	10 STEP Stair wave 2.2V _{p-p} R _L =5k	—	0.5	3.0	deg
Sync. Separation Level	V _{SEPA}	Level from Sync. top	90	120	150	mV

(Note 1): AFC input is composite synchronous signal.

(Note 2): Time lag between horizontal synchronous signal with AFC and without AFC. (The timing gap at 9 pin output, in the case of 8 pin =high, and 8 pin=low.)

■ TEST CIRCUIT

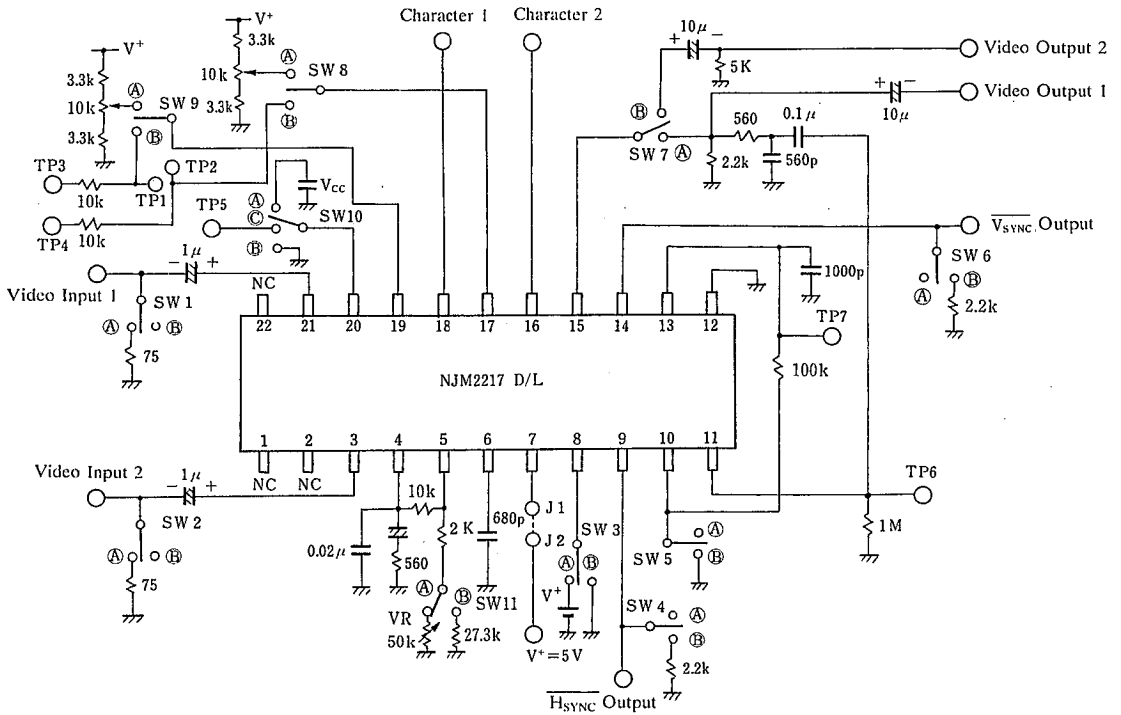

■ AFC CIRCUIT CONFIGURATION & ITS FEATURE

The NJM2217 has AFC function of horizontal synchronous signal applied to character generator. AFC circuit of the NJM2217 is like PLL circuit and operates as band pass filter. If pulse Noise is mixed to the input horizontal synchronous signal of AFC circuit, it does not appear at AFC output when AFC circuit is on the lock condition. Because if noise appeared at output of phase comparator, low pass filter takes off it and it is not carried to VCO circuit. (Fig.1).

Fig.2 shows block diagram of AFC circuit.

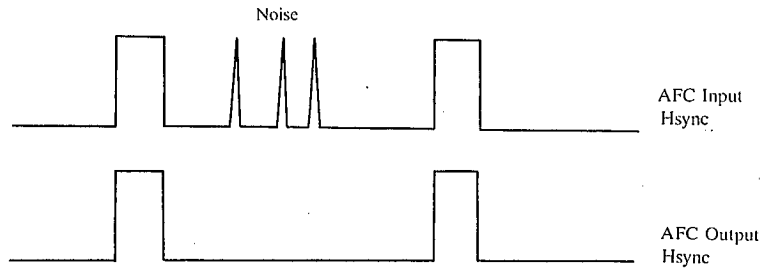

Fig.1 Input and Output of AFC circuit with Mixed Noise

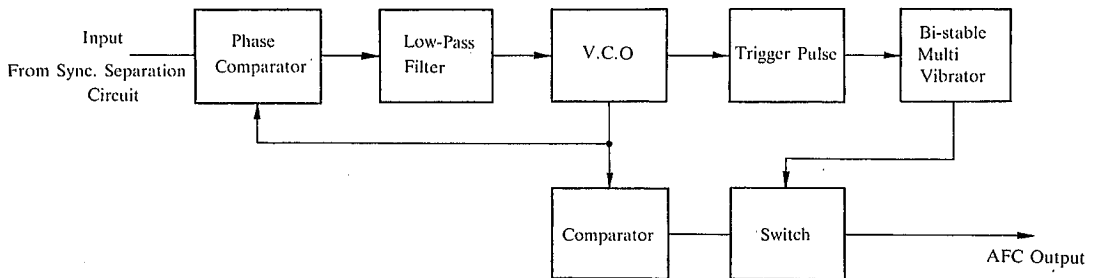

Fig.2 AFC Circuit Configuration

5

■ TEST CIRCUIT CONDITION

PARAMETER	INPUT	OUTPUT	SW1	SW2	SW3	SW4	SW5	SW6	SW7	SW8	SW9	SW10	APPENDIX	
I _{CC}		J ₁ -J ₂ Current	B	B	B	A	A	A	A	A	A	B	No Signal	
V _{OS}	T.P3	T.P1	B	B							A	B	Voltage between T.P1~3 & T.P2~4, at DC 2.5V to T.P3 & T.P4, DC 1.5V to character 1 & 2	
	T.P4	T.P2	B	B							B	A		
V _{TH}	T.P5 chra. 1, 2	Video Out 1									A	A	C	Voltage of video output 1, when video signal to video input 1, DC0→2V to T.P5, character 1, 2
G _V	Video In 1	Video Out 1								B			B	Input; 2.2V _{p-p} , 10 STEP stair wave
	Video In 2	Out 2											A	
G _F	Video In 1	Video Out 1											B	Input; 2V _{p-p} , Video sweep signal (0~5MHz)
	Video In 2	Out 2	↓	↓									A	
C _T	Video In 1	Video Out 1	B	A									A	Input; 2V _{p-p} , Sine wave. 3.58MHz
	Video In 2	Out 2	A	B									B	
DG	Video In 1	Video Out 1	B	B									B	Input; 2.2V _{p-p} , 10 STEP stair wave. Chroma 40IRE
	Video In 2	Out 2	B	B									A	
DP	Video In 1	Video Out 1	B	B						↓			B	Input; 2.2V _{p-p} , 10 STEP stair wave Chroma 40IRE
	Video In 2	Out 2	B	B		↓				B			A	
V _{IHH} V _{IHL}	Video In 1	\overline{H}_{SYNC}	B	B		B			↓	A			B	Input; standard color bar signal, 2V _{p-p}
V _{VH} V _{VL}	Video In 1	\overline{V}_{SYNC}				A		B						Input; standard color bar signal, 2V _{p-p}
V _{SEPA}	Video In 1	\overline{H}_{SYNC}						A						Level from SYNC. signal top at T.P6
V _{TH}	Video In 1	\overline{V}_{SYNC}	↓	↓	↓	↓	↓	B	↓	↓	↓	↓		Test at T.P7 & \overline{V}_{SYNC} Pin (Note 1)
f _O	Video In 1	\overline{H}_{SYNC}	B	B	A	A	B	A	A	A	A	B		Count of frequency at \overline{H}_{SYNC} output with SW11 to ⑧.
f _L	Video In 1	\overline{H}_{SYNC}					A/B							Input; standard color bar 2V _{p-p} (Note 2)
f _C	Video In 1	\overline{H}_{SYNC}					A/B							Input; standard color bar, 2V _{p-p} (Note 2)
P _W	Video In 1	\overline{H}_{SYNC}			↓		A							Input; standard color bar, 2V _{p-p} (Note 3)
P _D	Video In 1	\overline{H}_{SYNC}	↓	↓	A/B	↓	A/B	↓	↓	↓	↓	↓	↓	Input; standard color bar 2V _{p-p} (Note 3)

(Note 1)

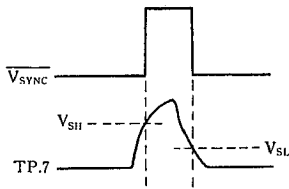

(Note 3)

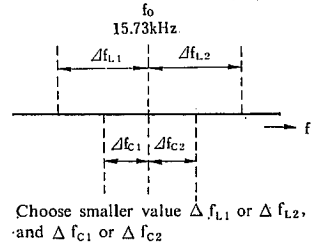
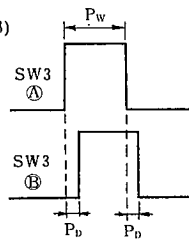

(Note 2): Lock Range: At that time from lock to unlock condition by changing variable resistor value, change SW5 to ⑥ and measure frequency at \overline{H}_{SYNC} output (upper and lower limit).

Capture Range: At that time from unlock to lock condition by changing variable resistor value, change SW5 to ⑥ and measure frequency at \overline{H}_{SYNC} output (upper and lower limit).

(Note 3): After adjusting \overline{H}_{SYNC} output frequency to 15.73kHz with SW5 to ⑥, changing SW3 alternately with AFC and without AFC condition of \overline{H}_{SYNC} and measure delay time of two signal rise and fall wave.

■ TERMINAL FUNCTION

PIN NO.	PIN NAME	FUNCTION	INSIDE EQUIVALENT CIRCUIT
1	NC	No connection	
2	NC	No connection	
3	VIDEO-IN 2	Video signal input terminal Sink chip clamp at 2.1V	
4	AFC-LPF	Connect AFC low pass filter.	
5	f FREE-CONT	Connect variable resistor and adjust free-run frequency.	

■ TERMINAL FUNCTION

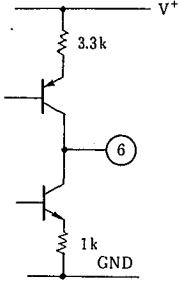
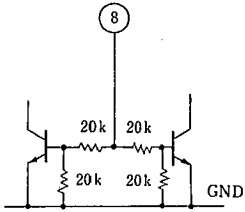
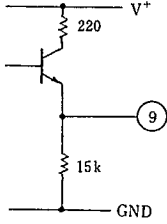
PIN NO.	PIN NAME	FUNCTION	INSIDE EQUIVALENT CIRCUIT
6	VCO-OUT	Connect capacitor to decide VCO frequency.	
7	V+	Supply voltage	
8	AFC-OUT CONT	Control Pin 9 signal.	
9	Hsync-OUT	Horizontal synchronous signal output pin. Emitter follower output.	

■ TERMINAL FUNCTION

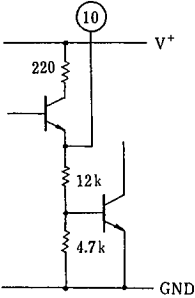
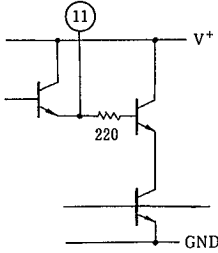
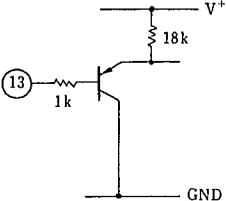
PIN NO.	PIN NAME	FUNCTION	INSIDE EQUIVALENT CIRCUIT
10	Sync Sepa-OUT	Synchronous separation circuit output. When testing free run oscillation frequency, short to GND.	
11	Sync Sepa-IN	Synchronous separation circuit input.	
12	GND	Ground	
13	Vsync Sepa-IN	Vertical synchronous reproduce circuit input.	

5

■ TERMINAL FUNCTION

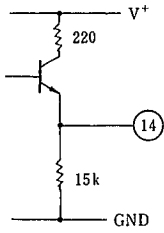
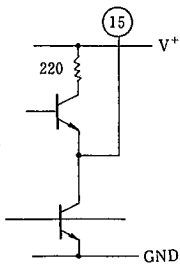
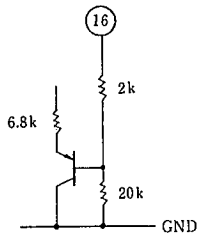
PIN NO.	PIN NAME	FUNCTION	INSIDE EQUIVALENT CIRCUIT
14	Vsync-OUT	Vertical synchronous output. (Emitter follower output)	
15	VIDEO-OUT	Video signal output. (Emitter follower output)	
16	Charact-IN 1	Control pin of video SW-3.	

■ TERMINAL FUNCTION

PIN NO.	PIN NAME	FUNCTION	INSIDE EQUIVALENT CIRCUIT
17	Lum-CONT 2	Luminance level adjustment of pin 16 character signal	
18	Charact-IN 1	Control pin of video SW-2	
19	Lum-CONT 1	Luminance level adjustment of pin 18 character signal.	

5

■ TERMINAL FUNCTION

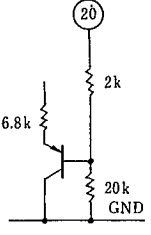
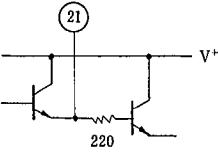
PIN NO.	PIN NAME	FUNCTION	INSIDE EQUIVALENT CIRCUIT
20	SW-CONT	Control pin of video SW-1. <u>Input</u> <u>SW-1 output</u> Low Video input 1 High Video input 2	
21	VIDEO-IN 1	Video signal input pin. Sink chip clamp at 2.1V.	
22	NC	No connection	

■ PRINCIPLES OF OPERATION

1) Video Switch

The NJM2217 has three video switches. One of them is used to select one video signal from two input video signal, and two others are used for super-imposer of character and background. Switching operation is done by putting DC voltage in to Pin 16,18 or 20, and its threshold voltage is 1.4V typical.

The NJM2217 has inside clamp circuit, and input video signal of Pin3 or Pin21 is sink-chip-clamped at 2.1V. Output circuit is emitter follower and drives to 5kΩ load.

2) Synchronous Separation Circuit

It separates composit synchronous signal from video signal, and this composit synchronous signal is applied to AFC circuit. And finally you can get horizontal synchronous signal (H_{sync}) from AFC circuit. Operation of synchronous separation is possible if signal level from synchronous signal top is more than 120mV_{p-p}.

3) Vertical Synchronous Reproduce Circuit

Composit signal from synchronous separation circuit is applied to integrator and triangle wave from it goes to schmitt trigger circuit which reproduces vertical synchronous signal. Output circuit is emitter follower and output voltage is 4V_{p-p} at 2kΩ load.

4) AFC Circuit

Fig.3 shows block diagram of AFC circuit. Voltage proportional to phase difference between horizontal synchronous signal putted in to phase comparator and triangular wave from VCO is smoothed by low pass filter and is put in to VCO. This VCO frequency is changed to direction of coincidence with input frequency. Triangular wave from VCO output flows through window comparator and 5μs width of output pulse signal which is same width to H_{sync} appears.

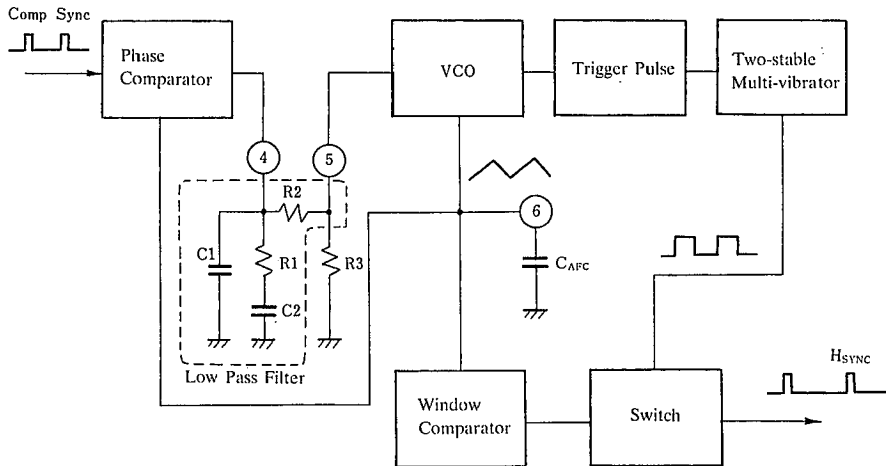

Fig.3 AFC Circuit Block

a) Free-Run Frequency

Free-run frequency depends on resistor R3 between Pin 5 and ground, and capacitor C_{AFC} between Pin6 and ground.

$$f_{FREE} = 1/(3.3 \cdot C_{AFC} \cdot R3) [Hz] (1)$$

b) Parameter of Low Pass Filter

Impedance vs. frequency characteristic from Pin 4 to Pin 5 is shown on Fig.4.

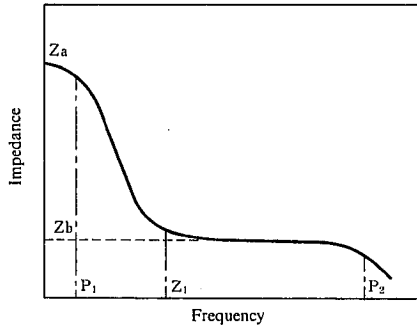

Fig.4 Low Pass Filter Impedance Characteristics

P_1, P_2, Z_1, Z_a, Z_b are shown below.

$$P_1 = 1 / \{ 2\pi C_2 (R_2 + R_3) \} \quad [\text{Hz}] \quad (2)$$

$$P_2 = 1 / (2\pi C_1 \cdot R_1) \quad [\text{Hz}] \quad (3)$$

$$Z_1 = 1 / (2\pi C_2 \cdot R_1) \quad [\text{Hz}] \quad (4)$$

$$Z_a = R_2 + R_3 \quad (\Omega) \quad (5)$$

$$Z_b = R_1 \quad (\Omega) \quad (6)$$

Z_a is decided by R_2 and R_3 is decided by free run frequency and so Z_a is generally decided by R_2 . Value of P_1, P_2, Z_1, Z_a, Z_b affects lock range, capture range, frequency fluctuations of AFC output and others. It is preferable that P_2 is 15kHz and Z_1 is 60Hz. When Z_b becomes large, lock and capture range becomes wide but fluctuations of AFC output frequency will increase. Large Z_a decreases fluctuations.

■ DESIGN EXAMPLE OF L.P. FILTER

$$P_1 = 2\text{Hz}$$

$$P_2 = 16\text{kHz}$$

$$Z_1 = 60\text{Hz}$$

$$Z_a = 40\text{k}\Omega$$

$$Z_b = 1\text{k}\Omega$$

$$C_{\text{AFC}} = 680\text{pF}$$

Each value of low pass filter is calculated below. If decided free run frequency to 15.74kHz, and from equation (1).

$$R_3 = 28.4\text{k}\Omega$$

$Z_a = 40\text{k}\Omega$ and equation (5),

$$R_2 = 12\text{k}\Omega$$

From equation (2),

$$C_2 = 2.1\mu\text{F}$$

From equation (4),

$$R_1 = 1.3\text{k}\Omega$$

From equation (3)

$$C_1 = 7700\text{pF}$$

Measured value at $R_1 = 1\text{k}\Omega, R_2 = 10\text{k}\Omega, C_1 = 1\mu\text{F}, C_2 = 2.2\mu\text{F}$.
 Lock range = 3.3kHz
 Capture range = 1.7kHz

(Note) Temperature characteristics of free run frequency, lock and capture range are deeply affected by temperature coefficient of C_{AFC} and each device of low pass filter, and so it is preferable using low temperature coefficient device. If temperature coefficient of C_{AFC} and R_3 is 0ppm/°C temperature coefficient of free run frequency is almost 0ppm/°C. (Ref. to typical characteristics graph.)

■ TYPICAL APPLICATION

Character superimposer on video signal.

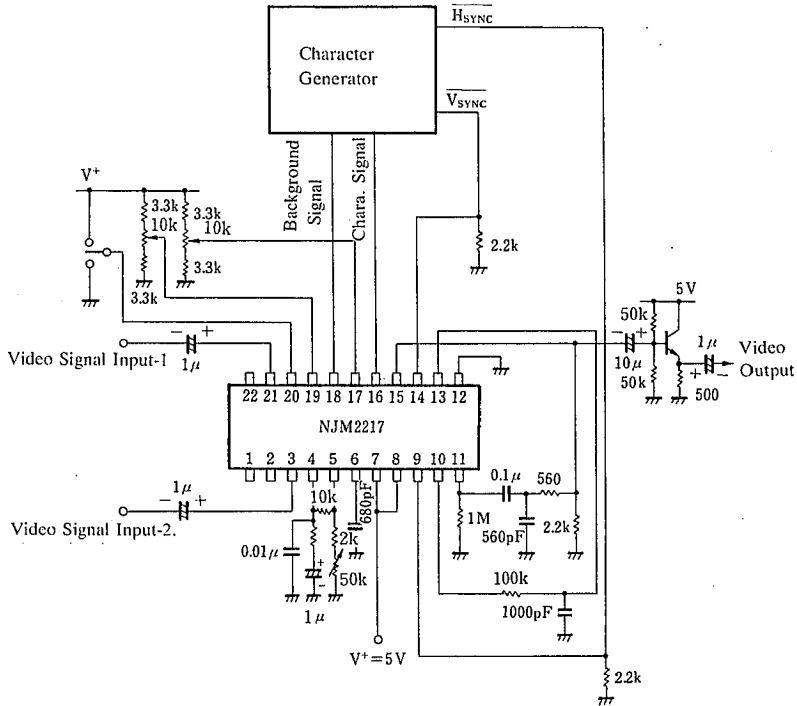

Synchronous separation of video signal.

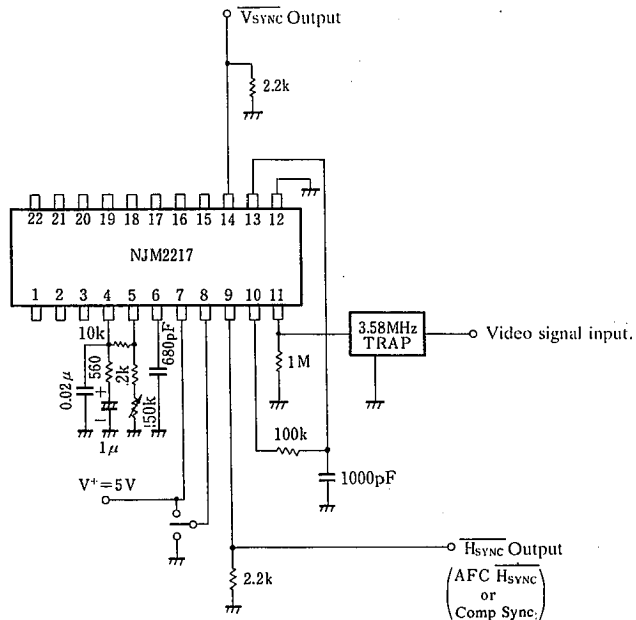

■ TYPICAL CHARACTERISTICS

Differential Gain/Differential

($T_a = 25^\circ\text{C}$)

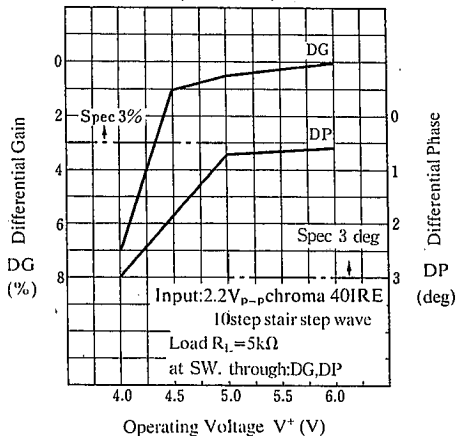

Differential Gain/Differential Phase

($V^+ = 5\text{V}$)

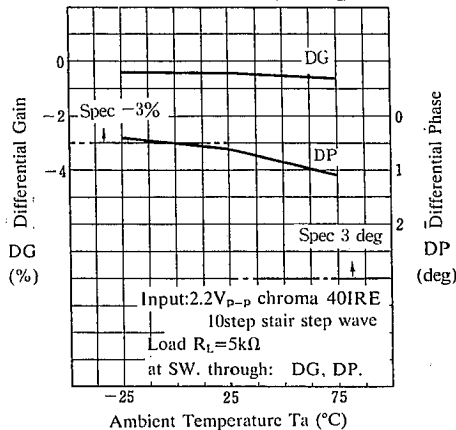

Video Switch Frequency Response

($V^+ = 5\text{V}$, $R_L = 5k\Omega$, $V_{IN} = 2V_{p-p}$ sine wave)

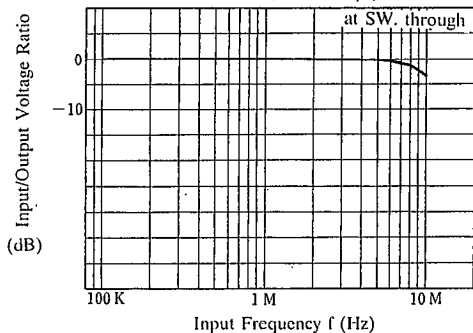

Differential Gain/Differential Phase

($V^+ = 5\text{V}$, $R_L = 5k\Omega$, $T_a = 25^\circ\text{C}$)

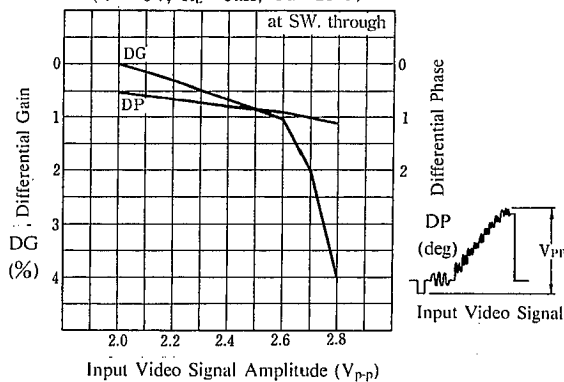

AFC Free Run Frequency

($V^+ = 5\text{V}$, $f = 15.735\text{kHz}$, $T_a = 25^\circ\text{C}$)

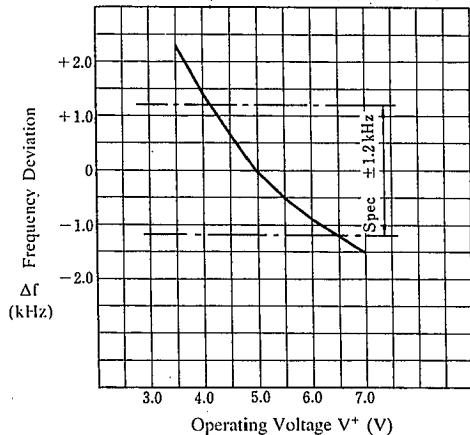

AFC Free Run Frequency

($T_a = 25^\circ\text{C}$, $f = 15.735\text{kHz}$, $V^+ = 5\text{V}$)

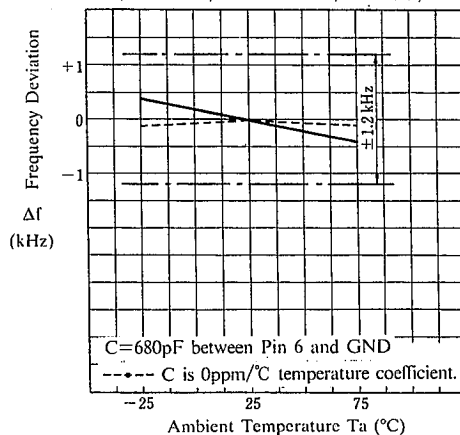

■ TYPICAL CHARACTERISTICS

Lock Range

($T_a = 25^\circ\text{C}$)

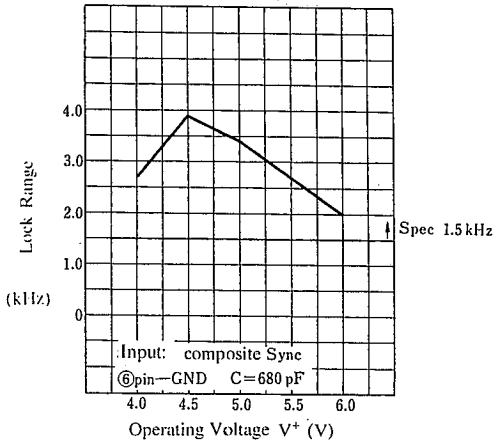

Lock Range

($V^+ = 5\text{V}$)

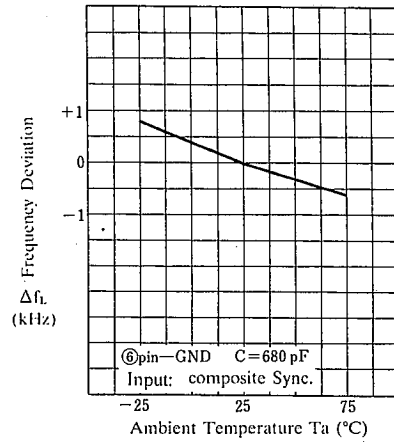

Capture Range

($T_a = 25^\circ\text{C}$)

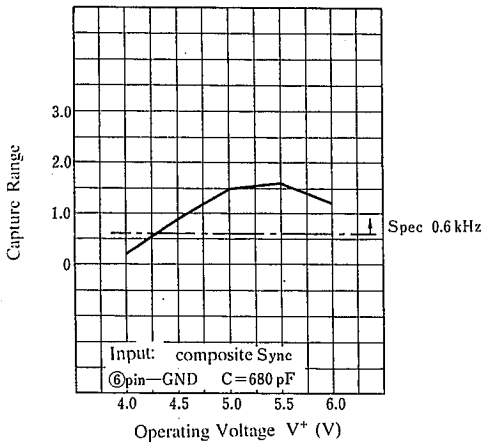

Capture Range

($V^+ = 5\text{V}$)

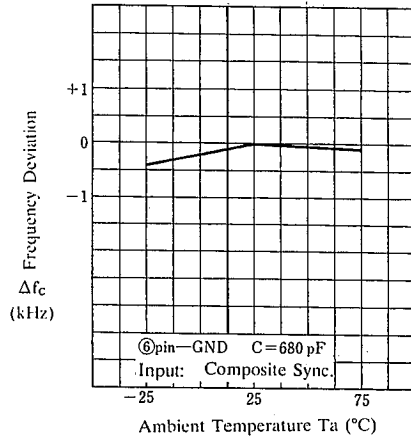

AFC Hsync Pulse width

($T_a = 25^\circ\text{C}$)

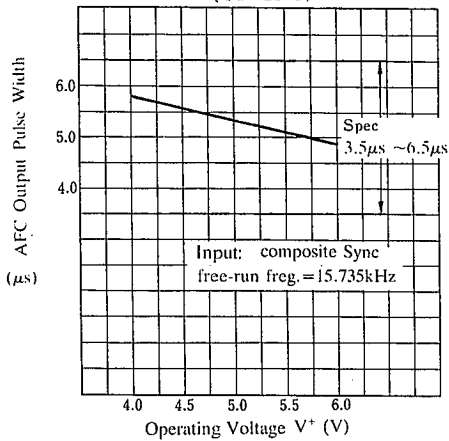

AFC Hsync Pulse Width

($V^+ = 5\text{V}$)

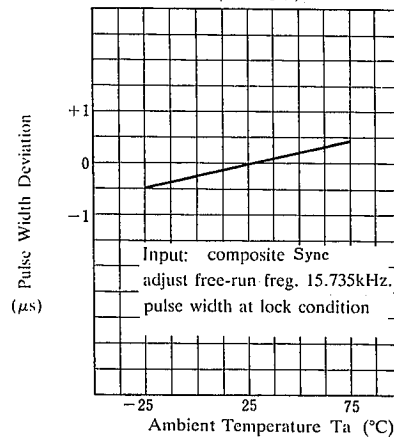

MEMO

[CAUTION]

The specifications on this databook are only given for information, without any guarantee as regards either mistakes or omissions. The application circuits in this databook are described only to show representative usages of the product and not intended for the guarantee or permission of any right including the industrial rights.