

# RC5532/RC5532A

## High Performance Dual Low Noise Operational Amplifier

### Features

- Small signal bandwidth – 10 MHz
- Output drive capability – 600Ω, 10 VRMS
- Input noise voltage – 5 nV/√Hz
- DC voltage gain – 50,000
- AC voltage gain – 2200 at 10 KHz
- Power bandwidth – 140 KHz
- Slew rate – 8 V/μS
- Large supply voltage range – ±3V to ±20V

### Description

The RC5532 is a high performance, dual low noise operational amplifier. Compared to standard dual operational amplifiers, such as the RC747, it shows better noise performance, improved output drive capability, and considerably higher small-signal and power bandwidths.

This makes the device especially suitable for application in high quality and professional audio equipment, instrumentation, control circuits, and telephone channel amplifiers. The op amp is internally compensated for gains equal to one. If very low noise is of prime importance, it is recommended that the RC5532A version be used which has guaranteed noise specifications.

### Block Diagram

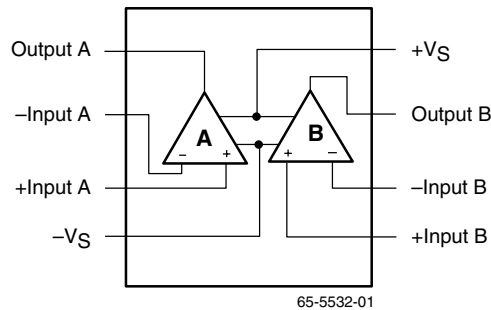

## Pin Assignments

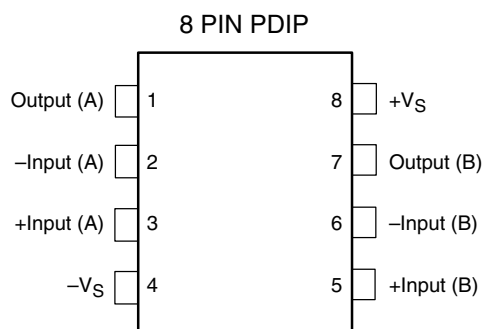

## Absolute Maximum Ratings

(beyond which the device may be damaged)<sup>1</sup>

Parameter		Min.	Typ.	Max.	Units
Supply Voltage				±22	V
Input Voltage				±Vs	V
Differential Input Voltage				0.5	V
P <sub>DTA</sub> < 50°C	PDIP			468	mW
Junction Temperature	PDIP			125	°C
Storage Temperature		-65		150	°C
Operating Temperature	RC5532/A	0		70	°C
Lead Soldering Temperature (10 sec)				300	°C

### Notes:

- Functional operation under any of these conditions is NOT implied.
- For supply voltages less than ±15V, the absolute maximum input voltage is equal to the supply voltage.
- Short circuit to ground on one amplifier only.

## Operating Conditions

Parameter		Min.	Typ.	Max.	Units
θ <sub>JA</sub>	Thermal resistance		160		°C/W
For T <sub>A</sub> > 50°C Derate at			6.25		mW/°C

## DC Electrical Characteristics

( $V_S = \pm 15V$  and  $T_A = +25^\circ C$  unless otherwise noted)

Parameters	Test Conditions	RC5532/5532A			Units
		Min.	Typ.	Max.	
Input Offset Voltage			0.5	4.0	mV
	Over Temperature			5.0	mV
Input Offset Current			10	150	nA
	Over Temperature			200	nA
Input Bias Current			200	800	nA
	Over Temperature			1000	nA
Supply Current			6.0	16	mA
	Over Temperature			22	mA
Input Voltage Range		$\pm 12$	$\pm 13$		V
Common Mode Rejection Ratio		70	100		dB
Power Supply Rejection Ratio		80	100		dB
Large Signal Voltage Gain	$R_L \geq 2\text{ K}\Omega$ , $V_{OUT} = \pm 10V$	25	100		V/mV
	Over Temperature	15	50		
	$R_L \geq 600\Omega$ , $V_{OUT} = \pm 10V$	15	50		
	Over Temperature	10			
Output Voltage Swing	$R_L \geq 600\Omega$	$\pm 12$	$\pm 13$		V
	$R_L = 600\Omega$ , $V_S = \pm 18V$	$\pm 15$	$\pm 16$		
	$R_L \geq 2k\Omega$				
Input Resistance (Diff. Mode)			300		K $\Omega$
Short Circuit Current			38		mA

### Notes:

- Diodes protect the inputs against over-voltage. Therefore, unless current-limiting resistors are used, large currents will flow if the differential input voltage exceeds 0.6V. Maximum input current should be limited to  $\pm 10\text{mA}$ .
- Over Temperature:  $RC = 0^\circ C \leq T_A \leq 70^\circ C$

## Electrical Characteristics

( $V_S = \pm 15V$  and  $T_A = +25^\circ C$ )

Parameters	Test Conditions	RC/RM5532A			Units
		Min.	Typ.	Max.	
Input Noise Voltage Density	$F_O = 30\text{ Hz}$		8.0	12	$\text{nV}/\sqrt{\text{Hz}}$
	$F_O = 1\text{ kHz}$		5.0	6.0	
Input Noise Current Density	$F_O = 30\text{ Hz}$		2.7		$\text{pA}/\sqrt{\text{Hz}}$
	$F_O = 1\text{ kHz}$		0.7		
Channel Separation	$F = 1\text{ kHz}$ , $R_S = 5\text{ k}\Omega$		110		dB

## AC Electrical Characteristics

( $V_S = \pm 15V$  and  $T_A = +25^\circ C$ )

Parameters	Test Conditions	Min.	Typ.	Max.	Units
Output Resistance	$A_v = 30$ dB Closed Loop, $F = 10$ kHz, $R_L = 600\Omega$		0.3		$\Omega$
Overshoot	Unity Gain, $V_{IN} = 100$ mV <sub>p-p</sub> $C_L = 100$ pF, $R_L = 600\Omega$		10		%
Gain	$F = 10$ KHz		2.2		V/mV
Gain Bandwidth Product	$C_L = 100$ pF, $R_L = 600\Omega$		10		MHz
Slew Rate			8.0		V/ $\mu$ S
Power Bandwidth	$V_{OUT} = \pm 10V$		140		KHz
	$V_{OUT} = \pm 14V$ , $R_L = 600\Omega$ , $V_S = \pm 18V$		100		KHz

## Test Circuits

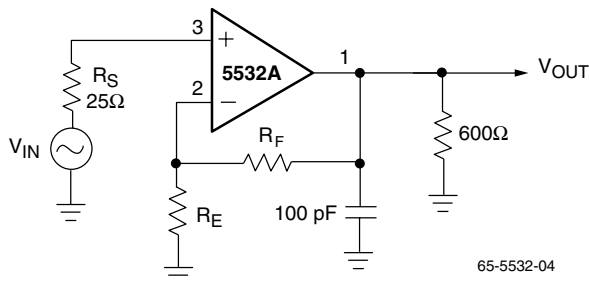

Figure 1. Closed Loop Frequency Response

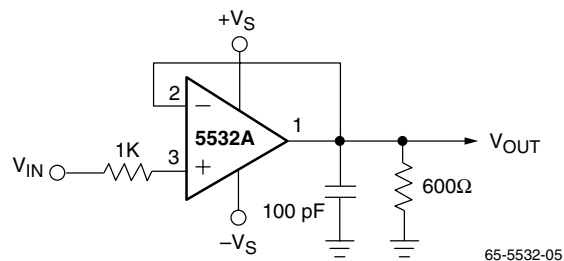

Figure 2. Follower, Transient Response

### Typical Performance Characteristics

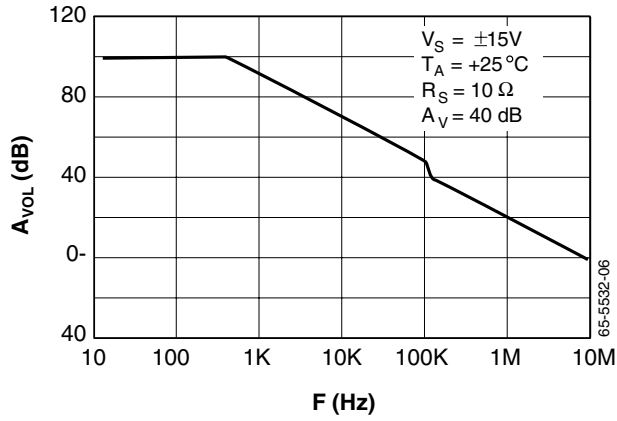

Figure 3. Open Loop Gain vs. Frequency

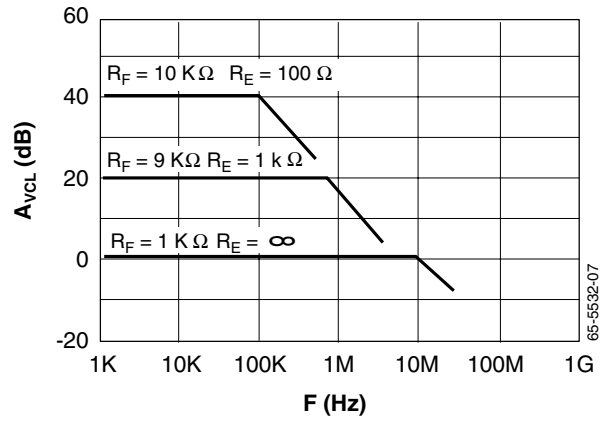

Figure 4. Closed Loop Gain vs. Frequency

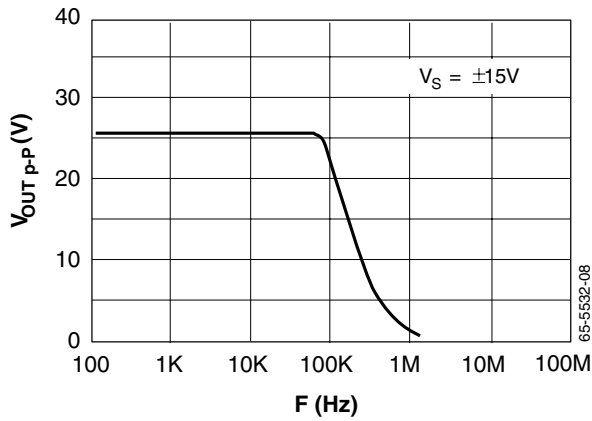

Figure 5. Output Voltage Swing vs. Frequency

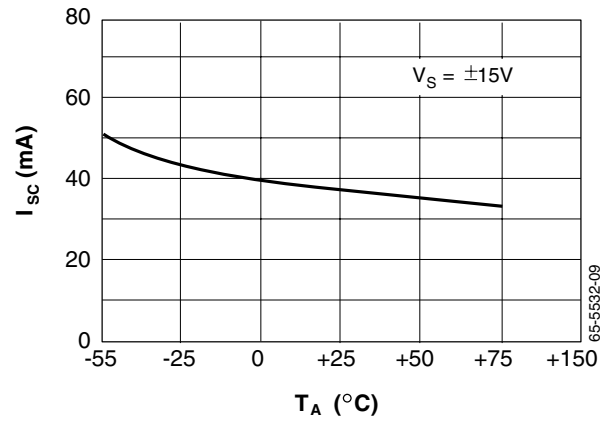

Figure 6. Short Circuit Current vs. Temperature

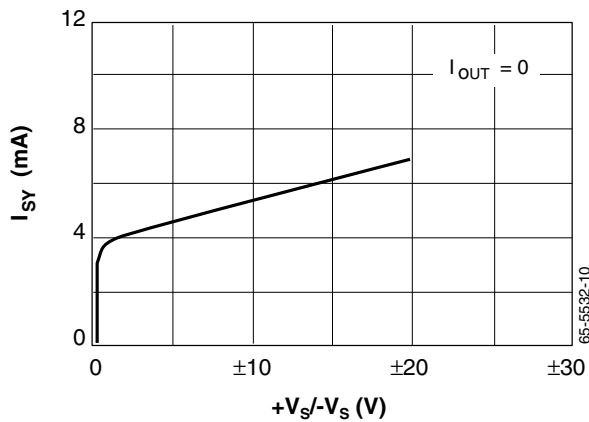

Figure 7. Supply Current vs. Supply Voltage

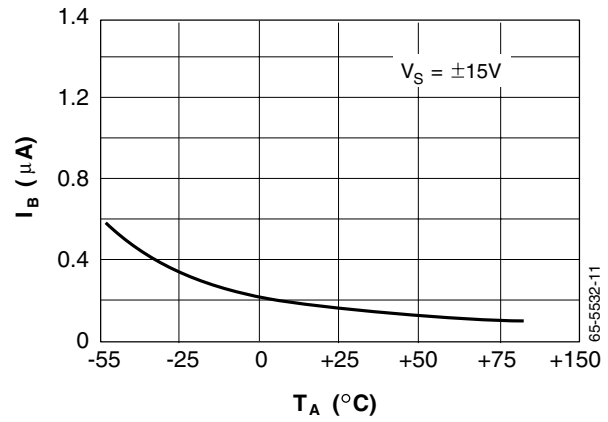

Figure 8. Input Bias Current vs. Temperature

Typical Performance Characteristics (continued)

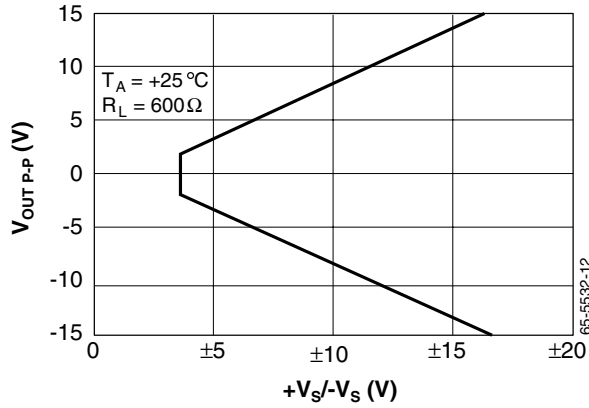

Figure 9. Output Voltage Swing vs. Supply Voltage

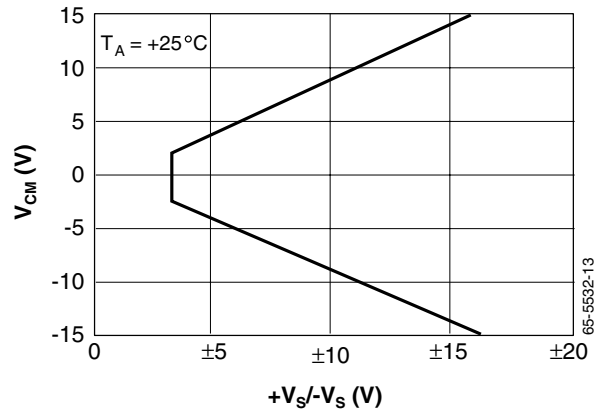

Figure 10. Common Mode Input Range vs. Supply Voltage

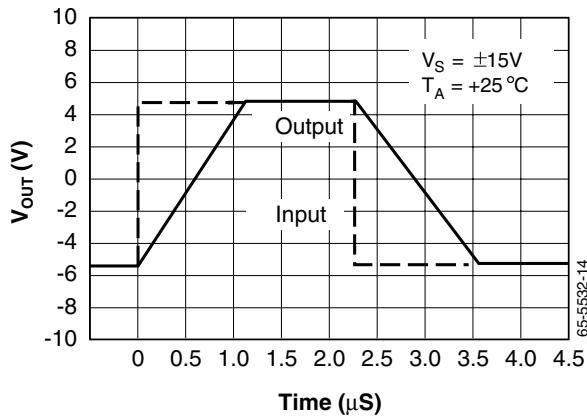

Figure 11. Follower Large Signal Pulse Response

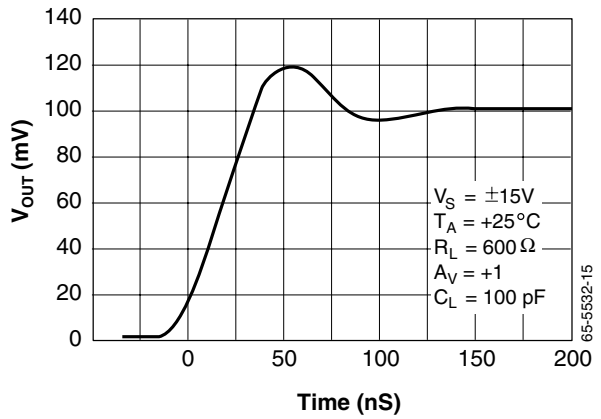

Figure 12. Transient Response Output Voltage vs. Time

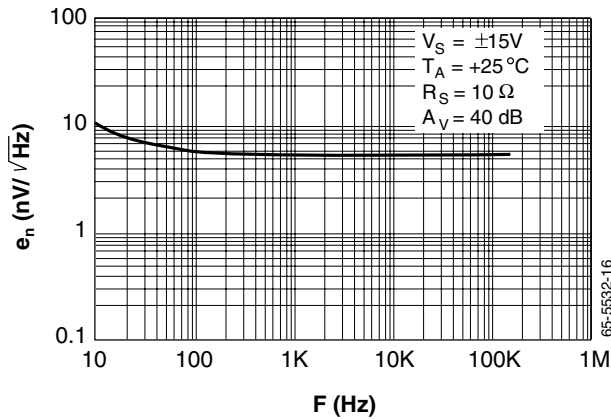

Figure 13. Input Noise Density vs. Frequency

# Mechanical Dimensions (continued)

## 8-Lead Plastic DIP Package

Symbol	Inches		Millimeters		Notes
	Min.	Max.	Min.	Max.	
A	—	.210	—	5.33	
A1	.015	—	.38	—	
A2	.115	.195	2.93	4.95	
B	.014	.022	.36	.56	
B1	.045	.070	1.14	1.78	
C	.008	.015	.20	.38	4
D	.348	.430	8.84	10.92	2
D1	.005	—	.13	—	
E	.300	.325	7.62	8.26	
E1	.240	.280	6.10	7.11	2
e	.100 BSC		2.54 BSC		
eB	—	.430	—	10.92	
L	.115	.160	2.92	4.06	
N	8°		8°		5

**Notes:**

1. Dimensioning and tolerancing per ANSI Y14.5M-1982.
2. "D" and "E1" do not include mold flashing. Mold flash or protrusions shall not exceed .010 inch (0.25mm).
3. Terminal numbers are for reference only.
4. "C" dimension does not include solder finish thickness.
5. Symbol "N" is the maximum number of terminals.

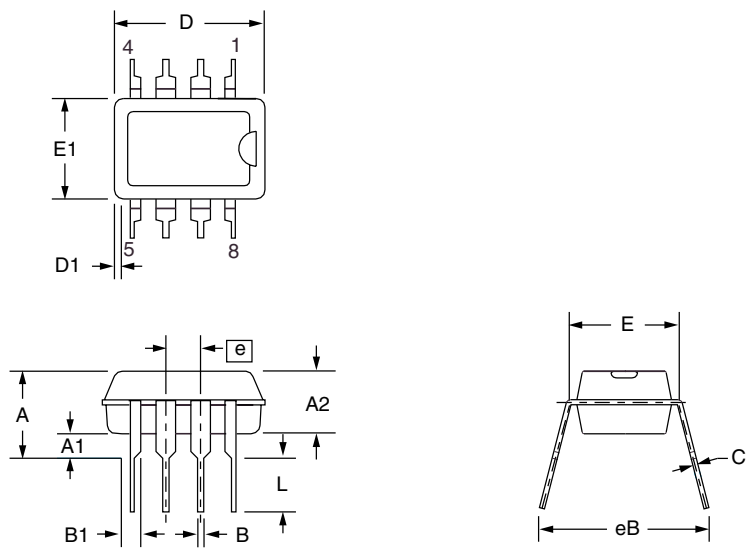

## Ordering Information

Product Number	Temperature Range	Screening	Package
RC5532N/RC5532AN	0°C to +70°C	Commercial	8 Pin Plastic DIP

### DISCLAIMER

FAIRCHILD SEMICONDUCTOR RESERVES THE RIGHT TO MAKE CHANGES WITHOUT FURTHER NOTICE TO ANY PRODUCTS HEREIN TO IMPROVE RELIABILITY, FUNCTION OR DESIGN. FAIRCHILD DOES NOT ASSUME ANY LIABILITY ARISING OUT OF THE APPLICATION OR USE OF ANY PRODUCT OR CIRCUIT DESCRIBED HEREIN; NEITHER DOES IT CONVEY ANY LICENSE UNDER ITS PATENT RIGHTS, NOR THE RIGHTS OF OTHERS.

### LIFE SUPPORT POLICY

FAIRCHILD'S PRODUCTS ARE NOT AUTHORIZED FOR USE AS CRITICAL COMPONENTS IN LIFE SUPPORT DEVICES OR SYSTEMS WITHOUT THE EXPRESS WRITTEN APPROVAL OF THE PRESIDENT OF FAIRCHILD SEMICONDUCTOR CORPORATION. As used herein:

1. Life support devices or systems are devices or systems which, (a) are intended for surgical implant into the body, or (b) support or sustain life, and (c) whose failure to perform when properly used in accordance with instructions for use provided in the labeling, can be reasonably expected to result in a significant injury of the user.
2. A critical component in any component of a life support device or system whose failure to perform can be reasonably expected to cause the failure of the life support device or system, or to affect its safety or effectiveness.