

**LA1838**

Single-Chip Home Stereo IC with Electronic Tuning Support

Overview

The LA1838 is designed for use in home stereo systems and is a single-chip tuner IC that provides electronic tuning functions for AM, FM IF, and MPX reception. It is optimal for use in products that adopt an automatic tuning system based on an IF count.

Functions

- AM: RF amplifier, mixer, oscillator, IF amplifier, detector, AGC, oscillator buffer, S-meter, narrow-band SD, IF buffer
- FM IF: IF amplifier, quadrature detector, S-meter, SD (signal detection), S-curve detection, IF buffer output
- MPX: PLL stereo decoder, stereo display, forced monaural, VCO stop, post amplifier, audio muting, adjacent channel interference rejection function

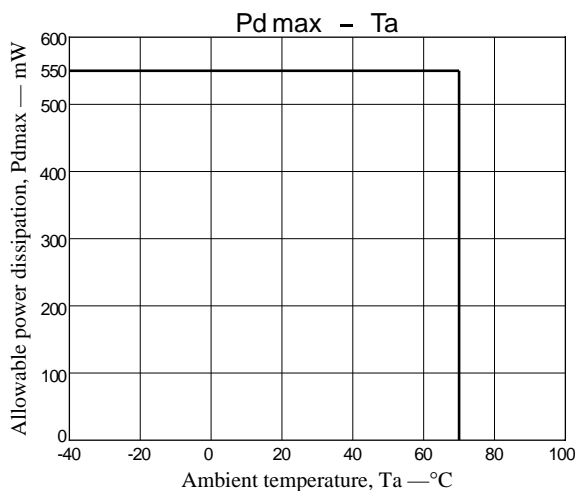

Features

- Integrated MPX VCO (External components are no longer required.)
- Built-in adjacent channel interference rejection function (third and fifth order)
- Adjustment-free FM detector circuit (Uses a ceramic discriminator.)
- The AM and FM SD sensitivities can be set independently.
- The AM and FM output levels can be set independently.
- Improved useable AM sensitivity and strong field distortion characteristics.

Package Dimensions

unit: mm

3061-DIP30S

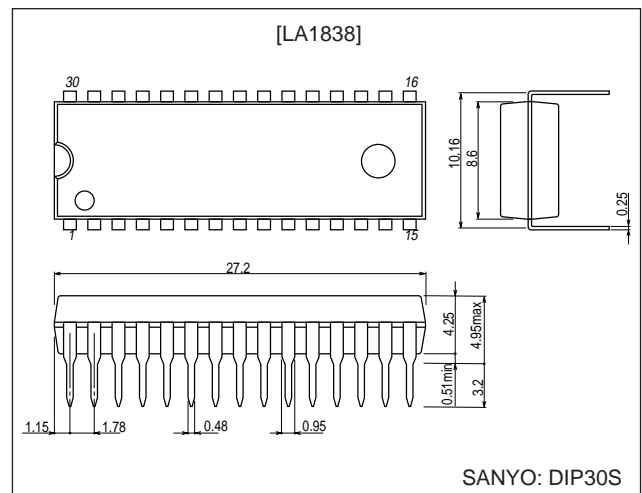

■ Any and all SANYO products described or contained herein do not have specifications that can handle applications that require extremely high levels of reliability, such as life-support systems, aircraft's control systems, or other applications whose failure can be reasonably expected to result in serious physical and/or material damage. Consult with your SANYO representative nearest you before using any SANYO products described or contained herein in such applications.

■ SANYO assumes no responsibility for equipment failures that result from using products at values that exceed, even momentarily, rated values (such as maximum ratings, operating condition ranges, or other parameters) listed in products specifications of any and all SANYO products described or contained herein.

SANYO Electric Co.,Ltd. Semiconductor Company

TOKYO OFFICE Tokyo Bldg., 1-10, 1 Chome, Ueno, Taito-ku, TOKYO, 110-8534 JAPAN

Specifications

Maximum Ratings at $T_a = 25^\circ\text{C}$

Parameter	Symbol	Conditions	Ratings	Unit
Maximum supply voltage	V_{CC} max		12	V
Allowable power dissipation	P_d max	$T_a \leq 70^\circ\text{C}$	550	mW
Operating temperature	T_{opr}		-20 to +70	$^\circ\text{C}$
Storage temperature	T_{stg}		-40 to +125	$^\circ\text{C}$

Operating Conditions at $T_a = 25^\circ\text{C}$

Parameter	Symbol	Conditions	Ratings	Unit
Recommended supply voltage	V_{CC}		9	V
Operating supply voltage range	V_{CCop}		7 to 11	V

Operating Characteristics at $T_a = 25^\circ\text{C}$, $V_{CC} = 9\text{ V}$, in the specified test circuit.

Parameter	Symbol	Conditions	Ratings			Unit
			min	typ	max	
[FM Mono Characteristics] $f_c = 10.7\text{ MHz}$, $f_m = 1\text{ kHz}$						
Current drain	I_{CCO-FM}	With no input signal	18	31	44	mA
Demodulator output	V_{OFM}	100 dB μ , 100% modulation, the pin 16 output	730	1100	1460	mVrms
Channel balance	C.B-mono	100 dB μ , 100% modulation, the pin 16 output/the pin 17 output	-1.5	0	+1.5	dB
Total harmonic distortion (mono)	THD_{FM}	100 dB μ , 100% modulation, the pin 16 output		0.3	1.5	%
Signal-to-noise ratio	S/N_{FM}	100 dB μ , 100% modulation, the pin 16 output	70	77		dB
AM rejection ratio	AMR	100 dB μ , AM 30% modulation, the pin 16 output	40	55		dB
Input limiting voltage	-3dBLS	100 dB μ , 100% modulation, referenced to the output, the input when the output is down by -3 dB	26	32	38	dB μ
LED indicator on sensitivity	SD_{On-FM}		47	57	67	dB μ
LED indicator on bandwidth	SD_{BW}	100 dB μ	130	210	300	kHz
IF counter buffer output	$V_{IFBuff-FM}$	100 dB μ , the pin 13 output	80	120	160	mVrms
S-meter output	V_{SM-FM1}	0 dB μ , the pin 11 output	0	0.1	0.5	V
	V_{SM-FM2}	100 dB μ , the pin 11 output	3.6	4.3	5.0	V
Mute attenuation	Mute-Att	100 dB μ , 100% modulation, the pin 16 output	75	85		dB
[FM Stereo Characteristics] $f_c = 10.7\text{ MHz}$, $f_m = 1\text{ kHz}$, L + R = 90%, Pilot = 10%, 100 dB μ						
Separation (left)	Sep_L	Left channel modulated. The pin 16 output/the pin 17 output	30	45		dB
Separation (right)	Sep_R	Right channel modulated. The pin 17 output/the pin 16 output	30	45		dB
Stereo on level	ST_{ON}	The pilot modulation such that V7 falls under 0.7 V	1.3	2.7	5	%
Stereo off level	ST_{OFF}	The pilot modulation such that V7 rises to over 4.5 V		1.5		%
Total harmonic distortion (main)	THD_{-main}	Left + right modulation. The pin 16 output.		0.3	1.5	%
Adjacent channel rejection ratio	Brej-3rd	$f_s = 113\text{ kHz}$, $V_s = 90\%$, pilot = 10% The left - right modulation 1 kHz demodulated output with respect to the pin 16 output		40		dB
	Brej-5th	$f_s = 189\text{ kHz}$, $V_s = 90\%$, pilot = 10% The left - right modulation 1 kHz demodulated output with respect to the pin 16 output		40		dB
[AM Characteristics] $f_c = 1000\text{ kHz}$, $f_m = 1\text{ kHz}$						
Current drain	I_{CCO-AM}	With no input signal	15	25	35	mA
Detector output	V_{OAM1}	23 dB μ , 30% modulation, the pin 16 output	100	180	360	mVrms
	V_{OAM2}	80 dB μ , 30% modulation, the pin 16 output	200	320	500	mVrms
Signal-to-noise ratio	S/N_{AM1}	23 dB μ , 30% modulation, the pin 16 output	18	22		dB
	S/N_{AM2}	80 dB μ , 30% modulation, the pin 16 output	49	55		dB
Total harmonic distortion	THD_{AM1}	80 dB μ , 30% modulation, the pin 16 output		0.4	1.2	%
	THD_{AM2}	80 dB μ , 80% modulation, the pin 16 output		1.0	4.0	%
LED indicator on sensitivity	SD_{On-AM}		17	27	37	dB μ
Local oscillator buffer output	V_{OSC-AM}	With no input signal, the pin 30 output	110	160	220	mVrms
IF counter buffer output	$V_{IFBuff-AM}$	80 dB μ , 100% modulation, the pin 13 output	160	220	300	mVrms
ST - IF output	$V_{STIF-AM}$	80 dB μ , 100% modulation, the pin 7 output	16	34	48	mVrms
S-meter output	V_{SM-AM}	0 dB μ , 100% modulation	0	0	0.2	V

LA1838

Block Diagram

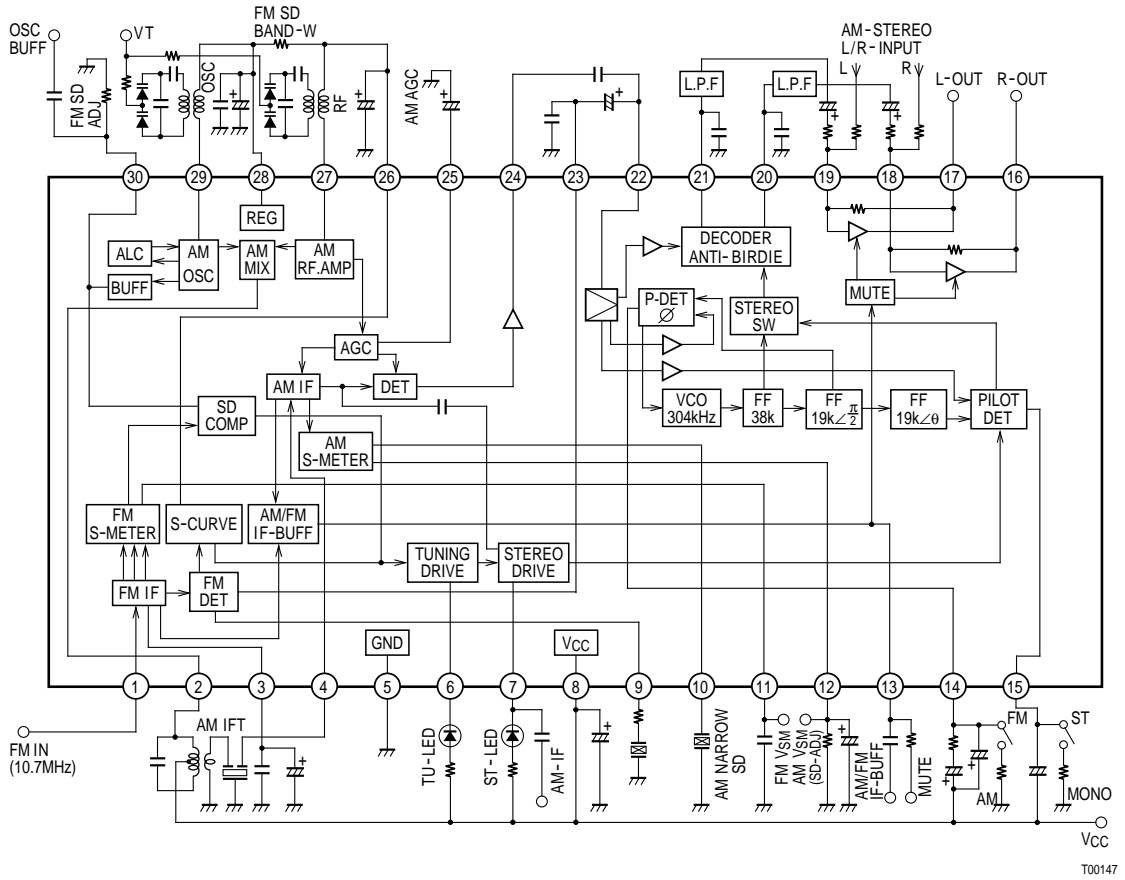

T00147

AC Test Circuit

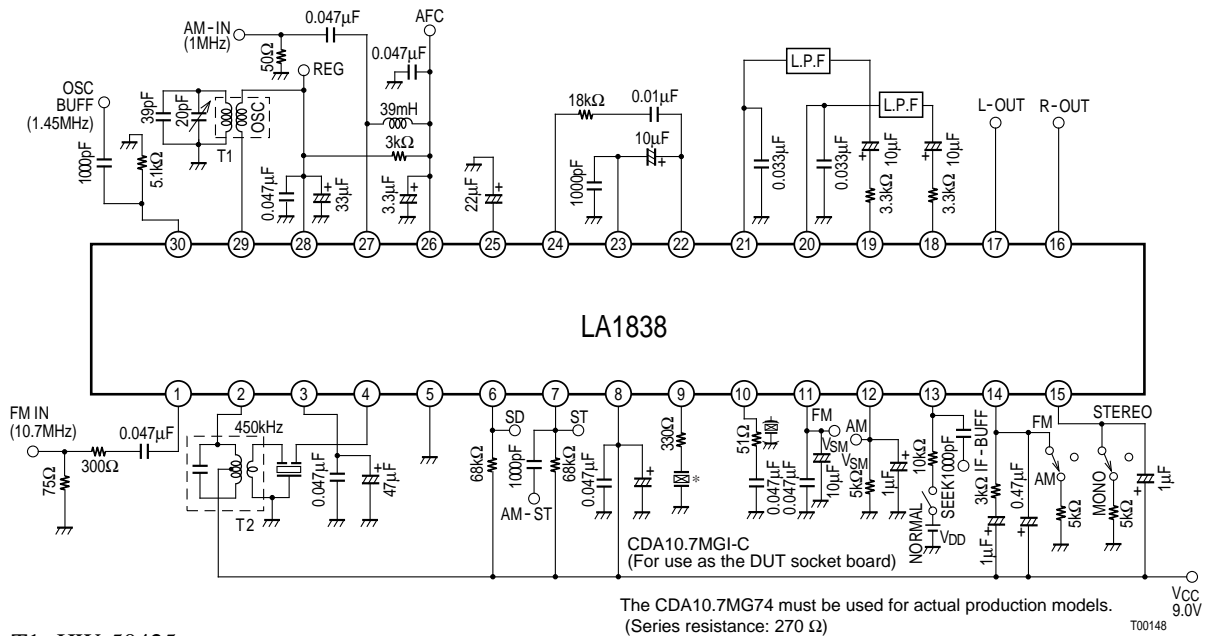

T00148

T1: HW-50425
T2: YD-1073-1

Coil Specifications

- AM oscillator (for the DUT)
HW-50425 (Mitsumi)

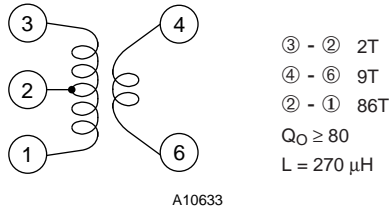

- IFT
YD-1073-1 (Mitsumi)

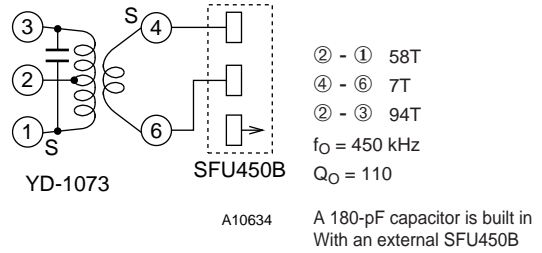

Pin Functions

Pin No.	Pin function	Pin voltage	Notes	Equivalent circuit
1	FM IF input	Vreg	Input impedance $r_i = 330 \Omega$	A10635
2	AM mixer output	VCC	Connect the mixer coil between this pin and VCC	A10636
3	FM IF input bypass	Vreg	Also used for the MPX regulator filter	A10635
4	AM IF input	Vreg	Input impedance $r_i = 2 \text{ k}\Omega$	A10637
5	GND	0 V		
6 7	TU-LED ST-LED, AF-IF output	VCC VCC	Active low Open collector AM stereo IF output (pin 7) The influx current must be held under 150 μA .	A10638
8	VCC	VCC		
9	FM detector	Vreg - 1.4	The CDA10.7 MG74 (Murata Mfg. Co., Ltd.) is recommended as the ceramic discriminator. A device with a series resistance of 270 Ω must be used.	A10639

Continued on next page.

LA1838

Continued from preceding page.

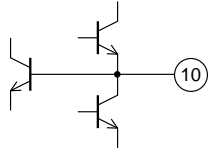
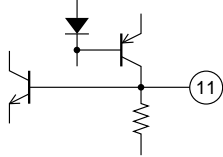
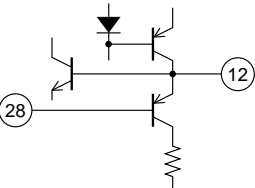
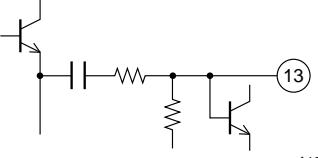
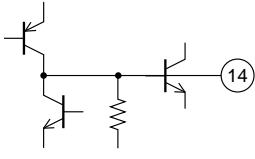
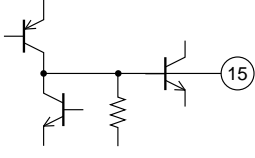
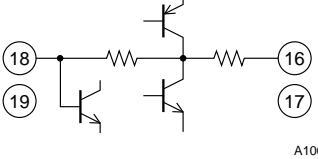
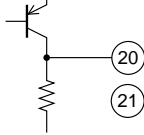
Pin No.	Pin function	Pin voltage	Notes	Equivalent circuit
10	AM narrow band CF connection	1.3 V	Recommended narrow band CF: BFU450 C4N (Murata Mfg. Co., Ltd.) When the narrow band SD function is not used, bypass this circuit with a 50 Ω resistor and a 0.047 μF capacitor in series.	 A10640
11	FM S-meter output	0 V	$R_L = 8\text{ k}\Omega$	 A10641
12	AM S-meter output	0 V (AM)	The AM SD sensitivity is adjusted with an external resistor connected between this pin and ground	 A10642
13	AM/FM IF buffer output, Output control switch (mute switch)	0 V	$V_{13} \leq 0.5\text{ V}$: Reception state $1.4\text{ V} \leq V_{13} \leq 2.2\text{ V}$: IF buffer output on $V_{13} \geq 3.5\text{ V}$: IF buffer output and muting on	 A10643
14	Phase comparator low-pass filter (AM/FM switching)	$V_{CC} - 1.4$ (FM) 0 V (AM)	The device operates in AM mode when this pin is connected to ground through a resistor. Limit values for the resistor: 2.7 kΩ (When $V_{CC} = 7\text{ V}$) 3.9 kΩ (8 V), 5.1 kΩ (9 V) 6.2 kΩ (10 V), 7.5 kΩ (11 V)	 A10644
15	Pilot detector low-pass filter (Forced mono) (VCO stop)	$V_{CC} - 1.0$	The device is forced to monaural when a current of over 50 μA flows from this pin. The VCO is stopped if this pin is connected to ground. The limit values for the resistor are the same as those for pin 14.	 A10645
16 17 18 19	Post-amplifier inputs and outputs	Vreg Vreg	Output impedance $r_o = 200\ \Omega$ Pin 16: Right output, pin 17: Left output Inverting input pins Pin 18: Right input, pin 19: Left input $R_{NF} = 33\text{ k}\Omega$	 A10646
20 21	MPS outputs	3.5 V 3.5 V	Output impedance $r_o = 3.3\text{ k}\Omega$ Pin 20: Right deemphasis Pin 21: Left deemphasis	 A10647

Continued on next page.

LA1838

Continued from preceding page.

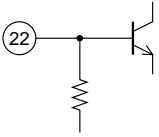
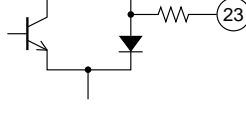
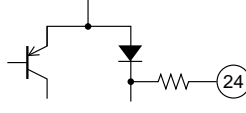
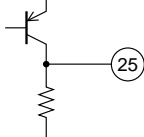
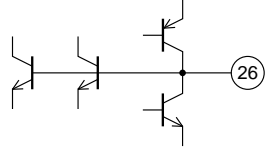
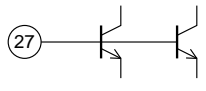
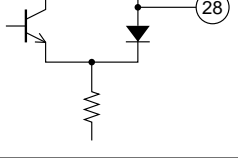
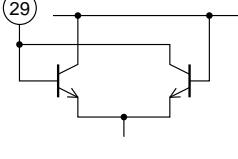
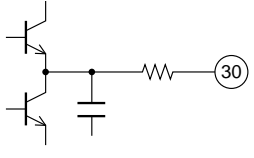
Pin No.	Pin function	Pin voltage	Notes	Equivalent circuit
22	MPX input	2.9 V	Input impedance $r_i = 20 \text{ k}\Omega$	 <p style="text-align: right;">A10648</p>
23	FM demodulator output	2.8 V (FM) 2.8 V (AM)	Output impedance $r_o = 3.0 \text{ k}\Omega$ The channel separation can be adjusted with an external capacitor connected between this pin and ground. The $V_O \text{ sub}/V_O \text{ main}$ ratio is set to be about 0 dB.	 <p style="text-align: right;">A10649</p>
24	AM detector output	0 V (FM) 0.5 V (AM)	Output impedance $r_o = 3.3 \text{ k}\Omega$ The AM frequency characteristics can be adjusted by modifying the time constant of the circuit connected between this pin and pin 22 and between this pin and ground.	 <p style="text-align: right;">A10650</p>
25	AM AGC	0 V (FM) 0.5 V (AM)	The resistance of the built-in resistor R is 11 kΩ	 <p style="text-align: right;">A10651</p>
26	AFC	Vreg	The FM SD bandwidth can be adjusted with the external resistor connected between this pin and pin 28	 <p style="text-align: right;">A10652</p>
27	AM RF input	Vreg	Must be used at the same potential as pin 28	 <p style="text-align: right;">A10653</p>
28	REG	Vreg	Vreg = 3.6 V	 <p style="text-align: right;">A10654</p>
29	OSC	Vreg	Connect the oscillator coil between this pin and pin 28	 <p style="text-align: right;">A10655</p>
30	Oscillator buffer output, FM SD sensitivity adjustment	1.6 V (FM) 1.3 V (AM)	The FM SD sensitivity can be adjusted with an external resistor connected between this pin and ground. Output impedance $r_o = 200 \Omega$	 <p style="text-align: right;">A10656</p>

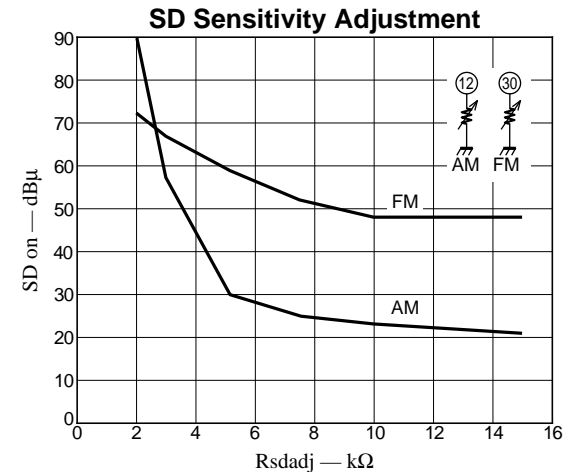
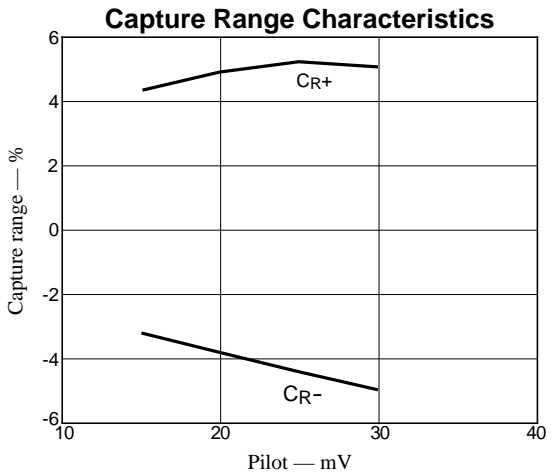
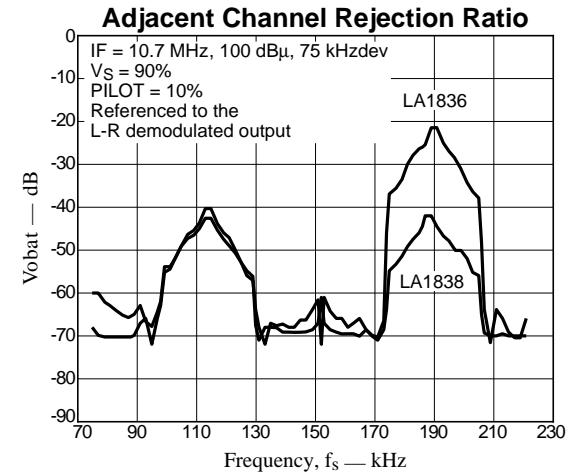
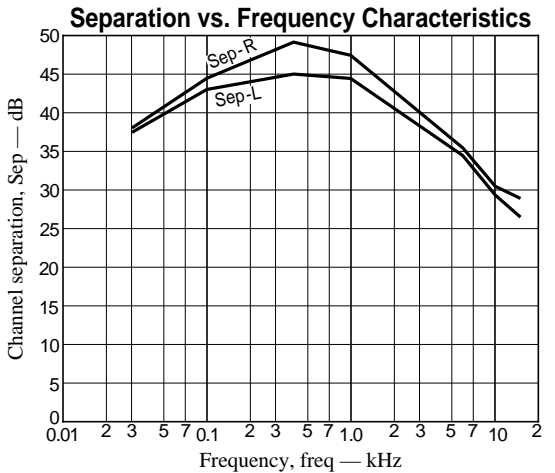
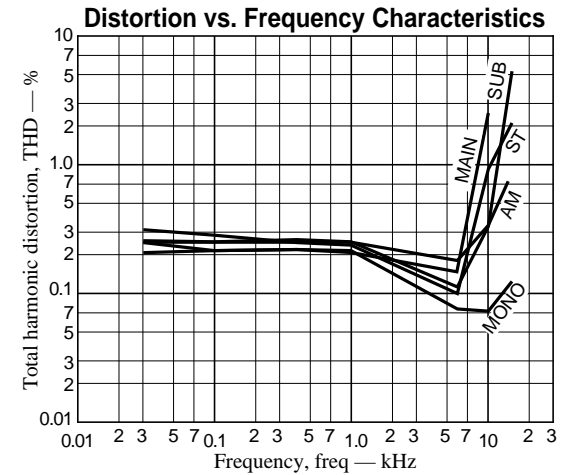
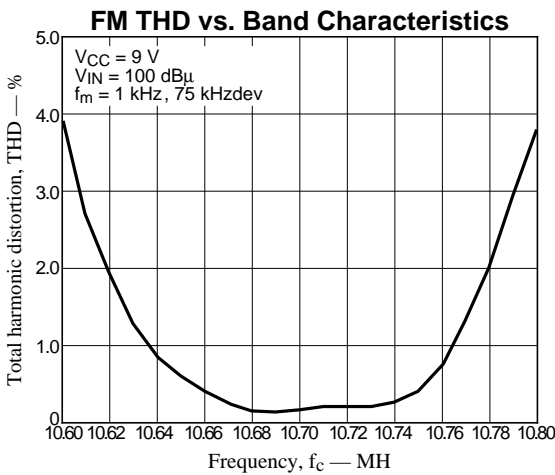
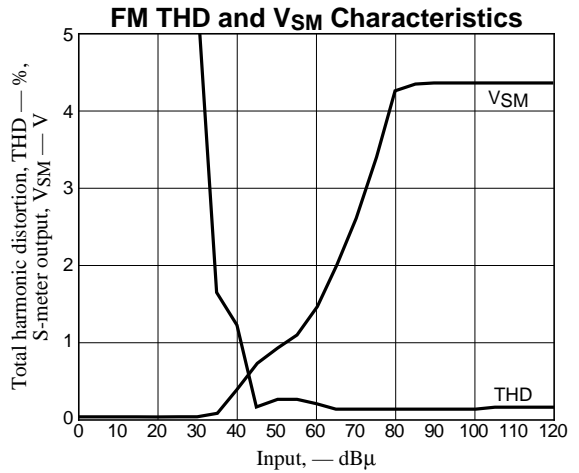
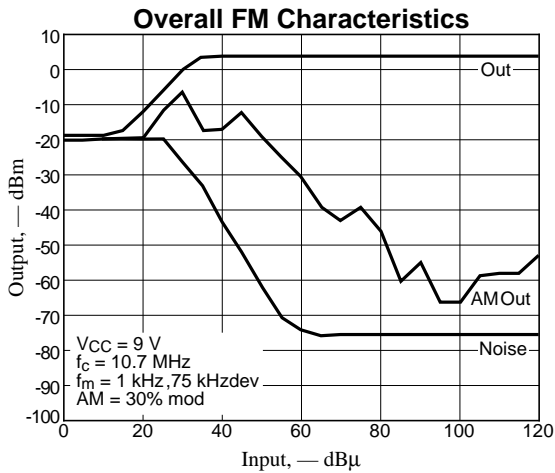

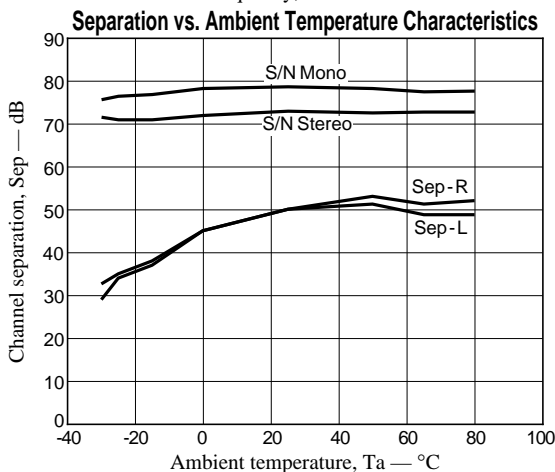
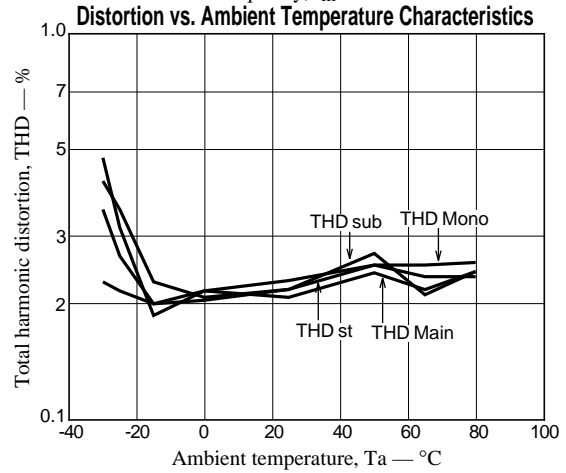
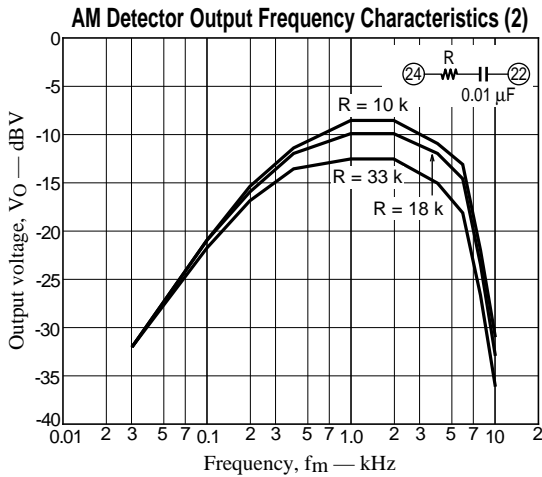
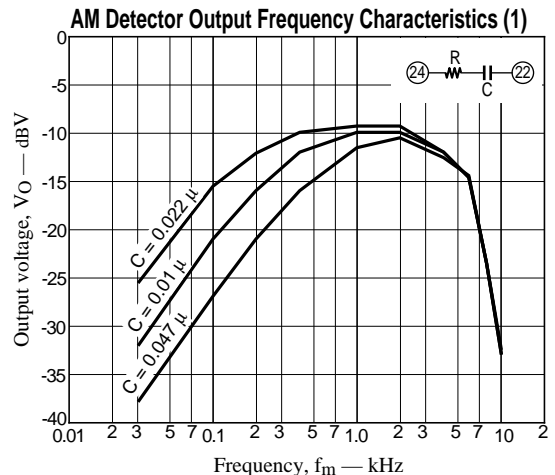
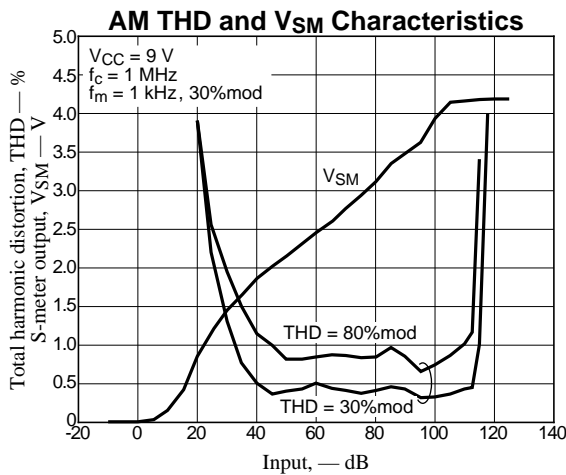
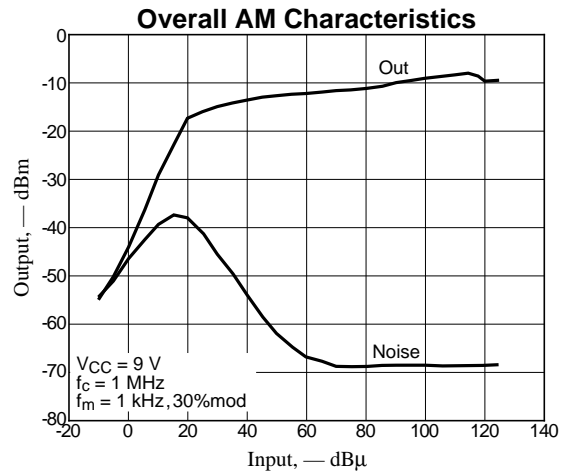
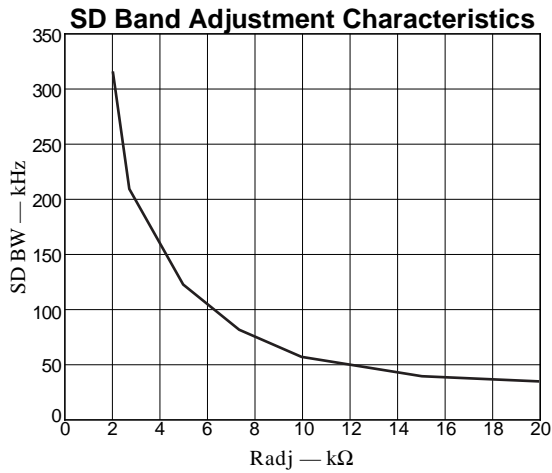

- Specifications of any and all SANYO products described or contained herein stipulate the performance, characteristics, and functions of the described products in the independent state, and are not guarantees of the performance, characteristics, and functions of the described products as mounted in the customer's products or equipment. To verify symptoms and states that cannot be evaluated in an independent device, the customer should always evaluate and test devices mounted in the customer's products or equipment.
- SANYO Electric Co., Ltd. strives to supply high-quality high-reliability products. However, any and all semiconductor products fail with some probability. It is possible that these probabilistic failures could give rise to accidents or events that could endanger human lives, that could give rise to smoke or fire, or that could cause damage to other property. When designing equipment, adopt safety measures so that these kinds of accidents or events cannot occur. Such measures include but are not limited to protective circuits and error prevention circuits for safe design, redundant design, and structural design.
- In the event that any or all SANYO products (including technical data, services) described or contained herein are controlled under any of applicable local export control laws and regulations, such products must not be exported without obtaining the export license from the authorities concerned in accordance with the above law.
- No part of this publication may be reproduced or transmitted in any form or by any means, electronic or mechanical, including photocopying and recording, or any information storage or retrieval system, or otherwise, without the prior written permission of SANYO Electric Co., Ltd.
- Any and all information described or contained herein are subject to change without notice due to product/technology improvement, etc. When designing equipment, refer to the "Delivery Specification" for the SANYO product that you intend to use.
- Information (including circuit diagrams and circuit parameters) herein is for example only; it is not guaranteed for volume production. SANYO believes information herein is accurate and reliable, but no guarantees are made or implied regarding its use or any infringements of intellectual property rights or other rights of third parties.

This catalog provides information as of April, 1999. Specifications and information herein are subject to change without notice.