

# M52775FP

## VIF, SIF, VIDEO, CHROMA, DEFLECTION FOR NTSC

### DESCRIPTION

The M52775FP is designed to provide a solution to NTSC color television system. It is an I<sup>2</sup>C bus controlled NTSC 1 chip. It consists of various processing blocks such as video IF, sound IF, luminance, chrominance, mono-sound, OSD display, interface, H and V deflection. At each block, I<sup>2</sup>C control is possible and a total of 30 parameters can be controlled by I<sup>2</sup>C bus.

### FEATURES

- AFT coil-less
- FM det coil-less
- Dynamic AGC
- AV switch (TV/EXT video)
- Y/C switch
- Built-in black stretch circuit
- Delay line aperture control
- Luminance peak limiter
- Two window vertical countdown
- Built-in chroma BPF and Trap
- Built-in Y Delay line
- Built-in ACC/Killer filters

### APPLICATION

NTSC type color TV, projector

### RECOMMENDED OPERATING CONDITION

Recommended supply voltage.....V3, 4, 21, 22, 23=4.75V  
 V5, 15, 16=8.0V  
 Supply voltage range.....V3, 4, 21, 22, 23=4.50 to 5.00V  
 V5, 15, 16 =7.6 to 8.8V  
 Maximum output current.....3.0mA (pin14)  
 4.0mA (pin13)  
 8.0mA (RGB output current)  
 3.0mA (AUDIO OUT output current)

### PIN CONFIGURATION (TOP VIEW)

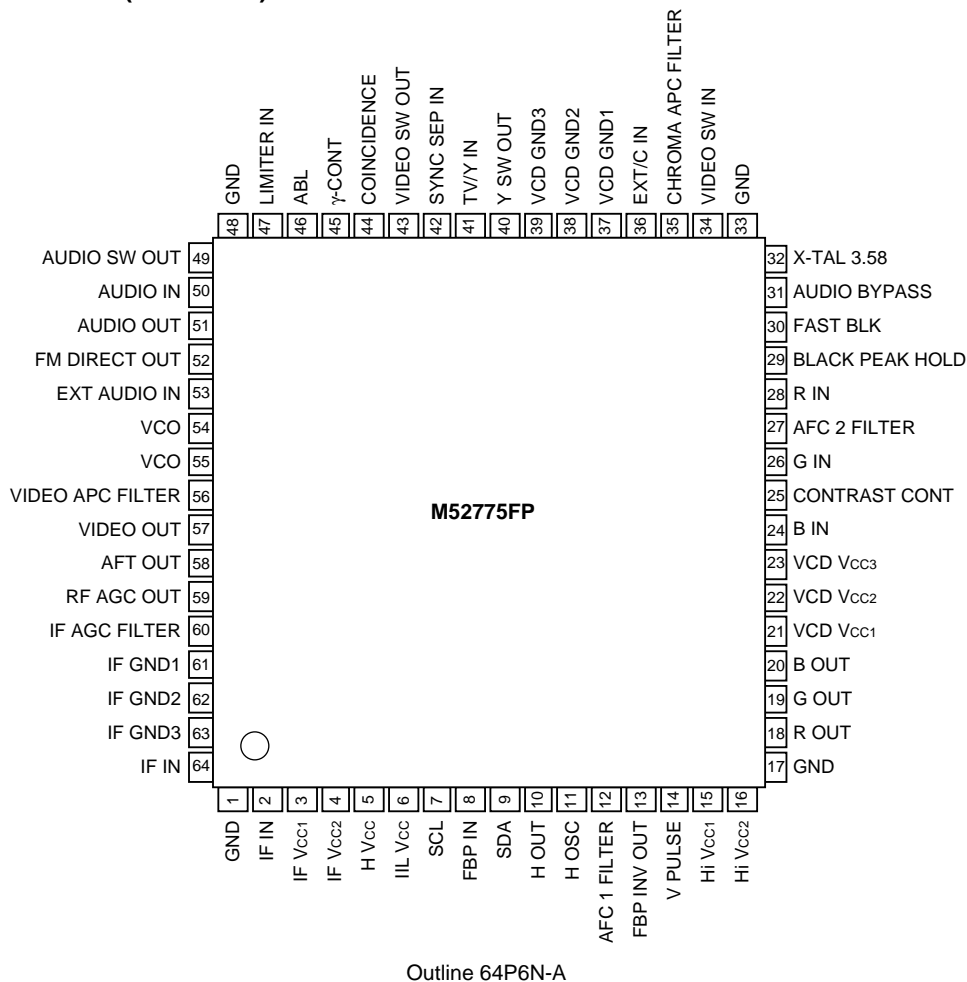

VIF, SIF, VIDEO, CHROMA, DEFLECTION FOR NTSC

BLOCK DIAGRAM

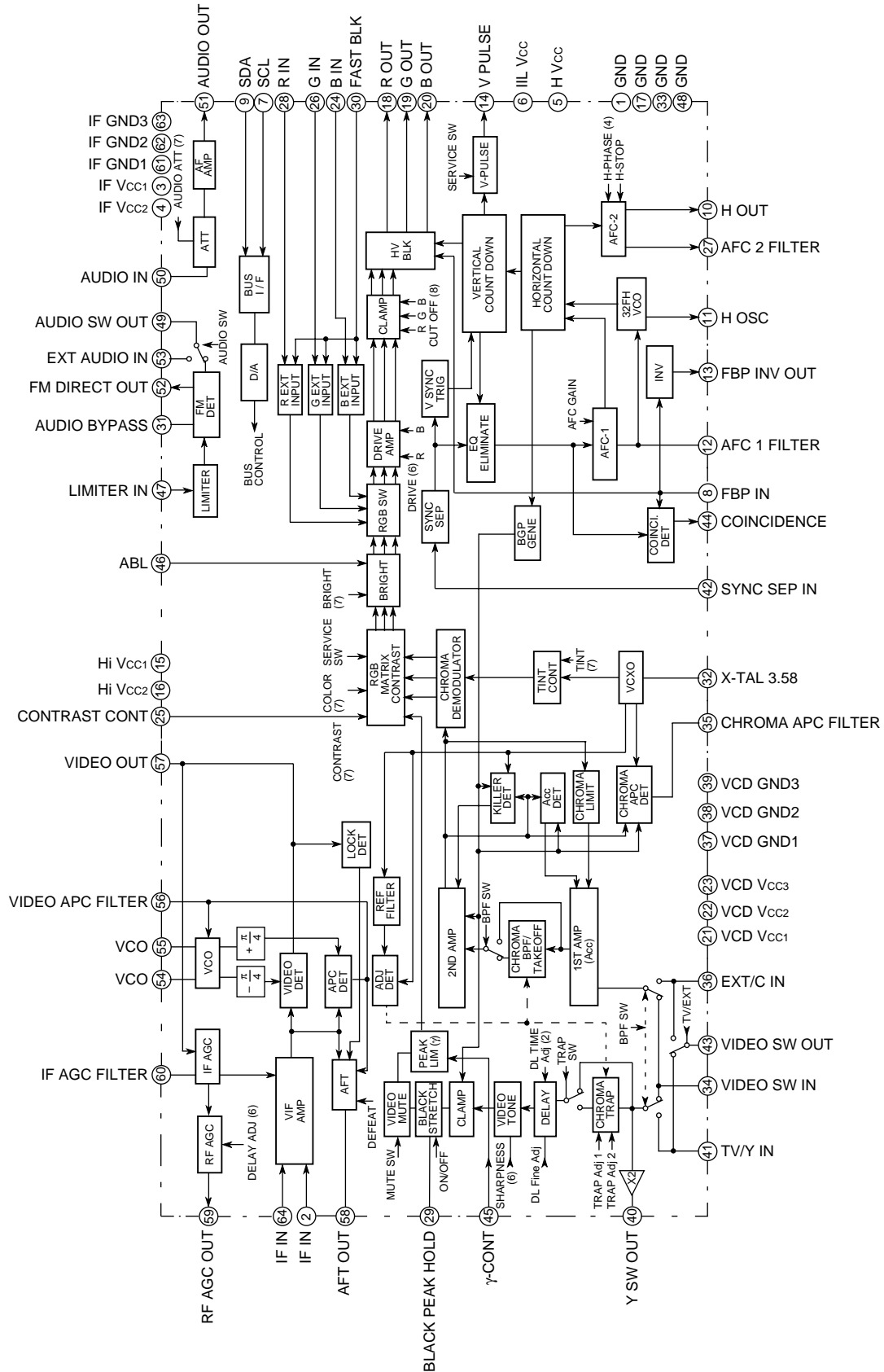





**M52775FP**

**VIF, SIF, VIDEO, CHROMA, DEFLECTION FOR NTSC**

**ELECTRICAL CHARACTERISTICS (cont.)**

Symbol	Parameter	Input signal		SW	Test conditions																		Limits			Unit	Note	
					Sub address function												Vcc											
		Input	SG	PIN	P49	P51	P52	P57	P58	P59	P60	00H DLA	01H VCOA	03H ATT	04H DEF-EAT	P34	P9	P15	P16	P21	P22	P23	Min.	Typ.	Max.			
AMR	AMR	47	SG20	SW PIN			M																	45	50	-	dB	
AFSN	AF S/N	47	SG17	SW PIN			M																	49	58	-	dB	
GEAu	EXT audio GAIN	53	SG22	SW PIN	M									40H 1										-2.0	0.0	2.0	dB	

**ELECTRICAL CHARACTERISTICS**

**chroma block** (\*C0 to C13:input SGS at pin41 IN)

Symbol	Parameter	Input signal		SW	Test conditions																		Limits			Unit	Note			
					Sub address function												Vcc													
		Input	SG	PIN	P12	P18	P19	P20	06H DLTA	07H TV/EXT	09H AU TO	05H TINT	08H HP	0BH CO NT	0BH COL	0BH V mu te	P34	P5	P16	P21	P22	P23	Min.	Typ.	Max.					
-	Default conditions of chroma	-	-	SW PIN	1	1	1																							
Cn1	Output signal amplitude 1	36	SS	SW PIN		M																			2000	2800	3600	mV <sub>P-P</sub>		
Cn2	Output signal amplitude 2	36	SS	SW PIN			M																		1900	2700	3500	mV <sub>P-P</sub>		
Acc1	Acc 1	36	VS v=+6dB	SW PIN			M																		1	4	6	dB		
Acc2	Acc 2	36	VS v=-20dB	SW PIN			M																			-3	0	3	dB	
OV	Chroma overload	36	VS eb=800mV	SW PIN			M																			-1	2	5	dB	
VikP	Threshold color killer on	36	VS v=variable	SW PIN			M																				-41	-30	dB	
killP	Residual color leakage at killer on	36	VS v=-45dB	SW PIN			M																			0	40	150	mV <sub>P-P</sub>	
APC1	APC Pull-in range 1	36	VS f=variable	SW PIN			M																			+300	+800	-	Hz	f=eb =ec
R/BP	Ratio of (R-Y/B-Y)	36	VS eb=monochroma	SW PIN		M	M																			0.60	0.81	1.00	-	ec=eb+100kHz
θR-Y P	Demoduration phase θR-Y	36	VS eb=monochroma	SW PIN		M	M																			80	95	110	deg	ec=eb+100kHz
CC	Residual carrier leakage	36	SS	SW PIN			M																			0	60	120	mV <sub>P-P</sub>	
TC1	Tint control 1	36	VS eb=monochroma	SW PIN			M							7FH 127												30	44	60	deg	
TC2	Tint control 2	36	VS eb=monochroma	SW PIN			M							00H 0												30	46	60	deg	

**M52775FP**

**VIF, SIF, VIDEO, CHROMA, DEFLECTION FOR NTSC**

No.	Sub address	08H	0BH		13H		
	function	COLOR	DR	MUTE	SER	HST	AFCG
Y0	DATA	00H	20H		00H		
	function	0	32	0	0	0	0

**ELECTRICAL CHARACTERISTICS**

**Video & RGB I/F block** (\* input SGS at pin42 IN. Vcc:P3, P4, P21, P22, P23=4.75V. P5, P15, P16=8.0V supply)

Symbol	Parameter	Input signal		SW	Test conditions																								Limits			Unit	Note
					Sub address function																												
					Input	SG	PIN	P18	P19	P20	P25	P40	P43	P45	P46	02H	04H	05H	06H				0AH	0BH	0CH	10H	Min.	Typ.	Max.				
-	Default conditions of video & RGB I/F	-	-	SW	1	1	1					00H	20H	40H	02H				40H	20H	20H	60H											
				PIN							0	0	0	32	0	64	2	0	1	0	0	64	32	0	32	96							
Ymax	Maximum video amplitude	34	SGA	SW										7FH									2.5	3.5	4.5	Vp-P							
				PIN	M	M	M							127																			
GY	Video gain	34	SGA	SW																			5	8	11	dB							
				PIN	M	M	M																										
FBY	Video frequency characteristics	34	SGB	SW																			-1	2	5	dB							
				PIN			M																										
2AGY	Double amplifier standard output	34	SGA	SW					M													20H	1.6	2.1	2.6	Vp-P							
				PIN																		32	0										
CTR1	Chroma trap attenuation 1	34	SGF	SW							00/20H											20H											
				PIN	M	M	M					0/1										32	0										
TRF1	Chroma trap fine adj. attenuation 1	34	SGF	SW							20/30H											20H			-18	dB							
				PIN	M	M	M					0/1	1									32	0	0/1									
YSW	Y SW OUT standard output	34	SGB	SW					M														0.51	0.71	0.91	Vp-P							
				PIN																													
YSmax	Y SW OUT maximum output	34	SGB	SW					M														1.0	1.4	1.8	Vp-P							
				PIN																													
E→T CT	EXT→TV crosstalk	36	SGB	SW					M						0EH/0AH									-	-50	-40	dB						
				PIN											1/0																		
T→E CT	TV→EXT crosstalk	34	SGB	SW					M						0AH/0EH									-	-45	-35	dB						
				PIN											0/1																		
YDL1	Y delay time 1	34	SGA	SW											08H								200	280	360	nsec							
				PIN	M	M	M								0																		
YDL2	Y delay time 2	34	SGA	SW											09H								150	200	250	nsec							
				PIN	M	M	M								1																		
YDL3	Y delay time 3	34	SGA	SW																			210	300	390	nsec							
				PIN	M	M	M																										
GTnor	Video tone 1	34	SGB	SW																			1.5	2.1	2.7	Vp-P							
				PIN	M	M	M																										
GTmax	Video tone 2	34	SGB	SW									3FH										-1.3	2.2	5.7	dB							
				PIN	M	M	M						63	0																			
GTmin	Video tone 3	34	SGB	SW									00H										-12	-8	-4	dB							
				PIN	M	M	M						0	0																			
GT2M	Video tone 4	34	SGB	SW																			-1.8	1.2	4.2	dB							
				PIN	M	M	M																										
GT5M	Video tone 5	34	SGB	SW																			-7	-3.5	0	dB							
				PIN	M	M	M																										











**ELECTRICAL CHARACTERISTICS TEST METHOD**

**P/N Video S/N**

1. Input SG3 and measure the rms value of output signal at pin 57.
2. P/N is defined as follows:

$$P/N=20\log \frac{V_{0NEG} \text{ measured value (VP-P)} \times 10^3 \times 0.7}{\text{Measured value (mVrms)}} \text{ (dB)}$$

**Vf Video frequency characteristics**

1. Input SG4 and set the frequency f2 to 44.75MHz so that the beat element of 1MHz is output to pin 57.
2. Then set the applied voltage at pin 60 so that the beat element of 1MHz at pin 57 may be 100dBμ.
3. Decrease f2 to the level at which the beat element becomes 3dB smaller than the element of 1MHz, and read the value at that level.

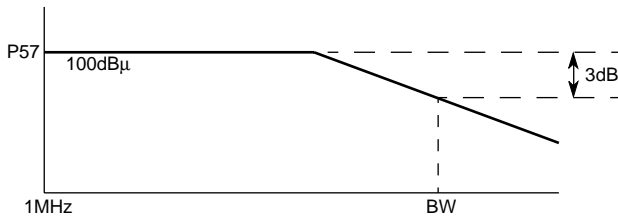

**Vin min. Input sensitivity**

1. Decrease SG5 level until the video detector output is 3dB smaller than the measured value of Parameter V3 "Video detector output".

**Vin max. Maximum permissible input**

1. Input 90dBμ SG6.
2. VA is the output level at pin 57. Increase SG6 voltage until the output at pin 57 becomes 3dB smaller than VA. The input level at that time is the maximum permissible input.

**μAFTN AFT detector sensitivity**

**V58H Maximum AFT voltage, V58L Minimum AFT voltage**

See the following figure.

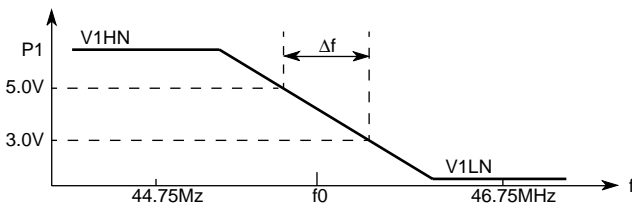

μAFTN is defined as follows:

$$\mu AFTN = \frac{(5.0-3.0) \times 10^3 \text{mV}}{\Delta f \text{ kHz}} \text{ (mV/kHz)}$$

**IM Intermodulation**

1. Adjust the applied voltage at pin 60 so that the lowest output signal voltage at pin 57 is 2.2V.



2. Measure elements of 0.92MHz and 3.579545MHz of output at pin 57.
3. IM is defined as follows:

$$IM=20\log \frac{\text{Element of 0.92MHz}}{\text{Element of 3.579545MHz}} \text{ (dB)}$$

**ATT Maximum attenuation**

1. Measure the element of 400Hz of output at pin 51.

$$ATT=20\log \frac{V_{0AFmax}}{\text{Measured value}} \text{ (dB)}$$

**LIM Input limiting sensitivity**

Decrease the input level of SG18. Measure the input level when the element of 400Hz at pin 52 is 3dB smaller than V0AFM (S6: Maximum AF output (6.0M)).

**AMR**

1. Vam is the element of 400Hz at pin 52.
2. AMR is defined as follows:

$$AMR=20\log \frac{V_{0AF} \text{ (mVrms)}}{V_{am} \text{ (mVrms)}} \text{ (dB)}$$

**AF S/N**

1. Measure the noise (20Hz to 100kHz) of output at pin 52.
2. AF S/N is defined as follows:

$$AF \text{ S/N} = 20\log \frac{V_{0AFmax}}{\text{Measured value}} \text{ (dB)}$$

**GEAu EXT Audio GAIN**

Input SG22 at pin 53, and measure the output VP-P at pin 49.

$$GAIN=20\log \frac{\text{Input signal VP-P}}{\text{Output signal VP-P (pin49)}} \text{ (dB)}$$

**Cn1 Output signal amplitude 1**

**Cn2 Output signal amplitude 2**

1. Input SS from pin 36 IN.
2. Measure output amplitude, Cn1 and Cn2, at pins 18 and 20 respectively.

**VIF, SIF, VIDEO, CHROMA, DEFLECTION FOR NTSC**

**Acc1**

1. Input VS (eb=570mV:level+6dB) from pin 36 IN.
2. Measure the output amplitude at pin 20.
3. Acc1 is defined as follows:

$$Acc1 = 20 \log \frac{\text{Measured value (V}_{P-P})}{Cn1 (V_{P-P})} \text{ (dB)}$$

**Acc2**

1. Input VS (input level:-20dB) from pin 36 IN.
2. Measure the output amplitude at pin 20.
3. Acc2 is defined as follows:

$$Acc2 = 20 \log \frac{\text{Measured value (V}_{P-P})}{Cn1 (V_{P-P})} \text{ (dB)}$$

**OV Chroma overload**

1. Input VS (ec=800mV:P-P:chroma+3dB) from pin 36 IN.
2. Measure the output amplitude at pin 20.
3. OL is defined as follows:

$$OL = 20 \log \frac{\text{Measured value (V}_{P-P})}{Cn1 (V_{P-P})} \text{ (dB)}$$

**VikP Threshold color killer on**

1. Input VS (level:variable) from pin 36 IN at input level 0dB.
2. Lower the input level whth monitoring the output amplitude at pin 20 and measure the input level when output amplitude isnot found.

**KillIP Residual color leakage at killer on**

1. Input VS (level:-45dB) from pin 36 IN.
2. Measure the output amplitude at pin 20.

**APC1 APC pull-in range 1**

1. Input VS (f=eb=ec=variable) from pin 36 IN.
2. Change the input signal frequency and measure the frequency range from the point at which signal is output to pin 20 and to the point that no signal is output to the pin. The reference value is 3.579545MHz.

**R/B P Ratio of (R-Y/B-Y)**

1. Input VS (eb=single chroma=ec+100kHz) from pin 36 IN.
2. V20 is the output amplitude at pin 20.
3. V18 is the output amplitude at pin 18.
4. R/B P is defined as follows:

$$R/B P = 20 \log \frac{V18 (V_{P-P})}{V20 (V_{P-P})} \text{ (dB)}$$

**θR-Y P Demodulation phase**

1. Input VS (ed=single chroma=ec+100kHz) from pin 36 IN.
2. V20 is the output amplitude at pin 20.
3. V18 is the output amplitude at pin 18.
4. R-Y P is defined as follows:

$$\theta_{R-Y P} = \tan^{-1} \frac{V18 \times 3.8}{(V20 \times 1.9) + 45^\circ} \text{ (deg)}$$

**CC Residual carrier leakage**

Measure the element of 3.58MHz of the demodulated output in no-input state.

**TC1 Tint control 1, TC2 Tint control 2**

1. Input VS (see the following figure) from pin 36 IN. Based on the output voltage at pin 20, find the absolute angle as shown in the following figure.

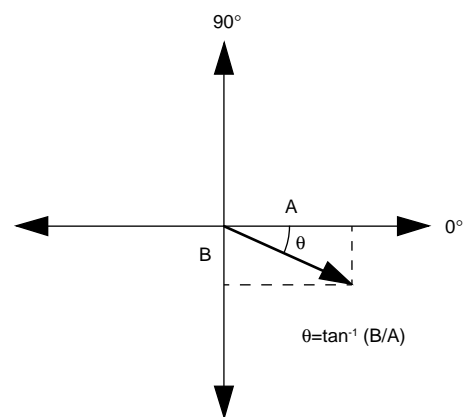
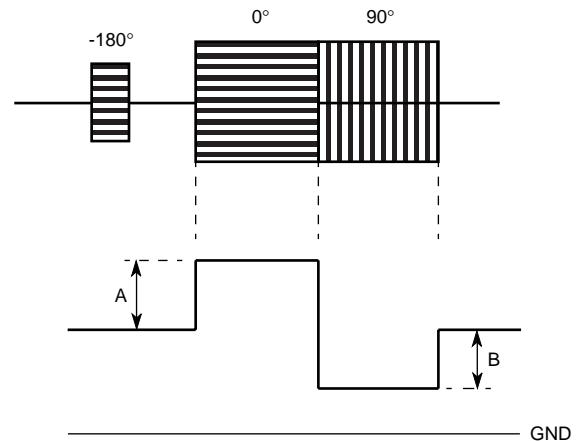

VIF, SIF, VIDEO, CHROMA, DEFLECTION FOR NTSC

**Ymax Maximum video output**

1. Input SGA into pin 34 IN and input SGS from pin 42 IN.
2. Measure the amplitude (P-P) except that at blanking part of output at pins 18, 19 and 20.



**GY Video gain**

1. Input SGA into pin 34 IN and input SGS from pin 42 IN.
2. Measure the amplitude (P-P) except that at blanking part of output at pins 18, 19 and 20. This amplitude is defined as G1.

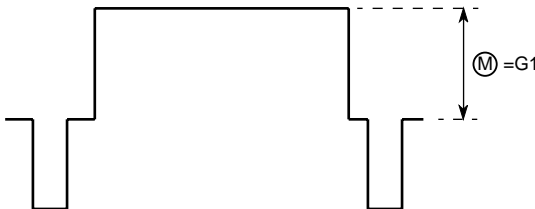

3. GY is defined as follows:

$$GY = 20 \log (G1VP-P / 0.714VP-P) \text{ (dB)}$$

**BW Video frequency characteristics**

1. Input SGB (5MHz, 0.4VP-P) into pin 34 IN and input SGS from pin 42 IN.
2. Measure the amplitude (P-P) except that at blanking part of the output at pin 19. The amplitude is defined as YB.
3. BW is defined as follow:

$$BW = 20 \log (YB VP-P / GY VP-P) \text{ (dB)}$$

**2AGY Double amplifier standard output**

1. Input SGA into pin 34 IN and input SGS from pin 42 IN.
2. Measure the amplitude (P-P) at pin 40 output.

**CTR1 Chroma trap attenuation 1 (common to R/G/B output)**

1. Input SS from pin 41 IN and input SGS into pin 42 IN. Measure the frequency level of 3.58MHz at trap data 0. The level is defined as No.
2. Then, measure the level at trap data 1.
3. CTR1 is defined as follows.

$$CTR1 = 20 \log \frac{\text{Measured value (mVP-P)}}{N_0 \text{ (mVP-P)}} \text{ (dB)}$$

**TRF1 Chroma trap fine adj. attenuation 1 (common to R/G/B output)**

1. Input SS from pin 34 IN and input SGS from pin 42 IN.
2. Measure the output amplitude of the element of 3.58MHz when trap fine adj. switch is on. (TRFon)

3. TRF1 is defined as follows.

$$TRF1 = 20 \log \frac{TRFon \text{ (mVP-P)}}{N_0 \text{ (mVP-P)}} \text{ (dB)}$$

4. Measure the most attenuation part in three condition of (2), and the most attenuation part is defined as Y6.

The three condition of (2) is shown below.

	TRAP FINE ADT SW	FINE 2
condition 1	ON	OFF
condition 2	OFF	ON
condition 3	ON	ON

**YSWY SW OUT standard output**

1. Input SGB from pin 34 IN and input SGS into pin 42 IN.
2. Measure the output amplitude of the pin 43 output video block.

**YSmax Y SW OUT standard output**

1. Input SGB (video amplitude 1.5VP-P) from pin 34 IN and input SGS into pin 42 IN.
2. Measure the output amplitude of the pin 43 output video block.

**E→T CT EXT→TV crosstalk**

1. Input SGB (f=5MHz) from pin 36 IN and input SGS into pin 42 IN.
2. Specify pin 43 output for EXT to be VEXT.
3. Specify pin 43 output for TV to be VTV.
4. E→T CT is defined as follows.

$$E \rightarrow T \text{ CT} = 20 \log \frac{VTV \text{ (mVP-P)}}{VEXT \text{ (mVP-P)}} \text{ (dB)}$$

**T→E CT TV→EXT crosstalk**

1. Input SGB (f=5MHz) from pin 41 IN and input SGS into pin 42 IN.
2. Specify pin 43 output for TV to be VTV.
3. Specify pin 43 output for EXT to be VEXT.
4. T→E CT is defined as follows.

$$T \rightarrow E \text{ CT} = 20 \log \frac{VEXT \text{ (mVP-P)}}{VTV \text{ (mVP-P)}} \text{ (dB)}$$

**YDL1 Y delay time1**

1. Input SGA from pin 34 IN and input SGS into pin 42 IN.
2. Measure the delay time from signal input to output at pins 18, 19 and 20.

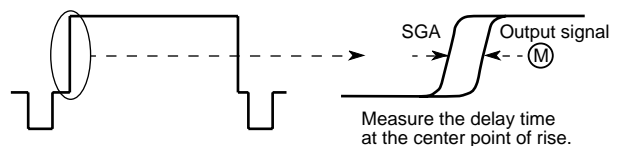

**YDL2 to 3 Y delay time2 to 3**

1. Input SGA from pin 34 IN and input SGS into pin 42 IN.
2. Measure the delay time from signal output at pins 18, 19 and 20 to Y11, YDL1.

**VIF, SIF, VIDEO, CHROMA, DEFLECTION FOR NTSC**

**GTnor Video tone 1**

1. Input SGB (f=3MHz) from pin 34 IN and input SGS into pin 42 IN.
2. Measure output amplitude at pins 18, 19 and 20.

**GTmax Video tone 2**

1. Input SGB (f=3MHz) from pin 34 IN and input SGS into pin 42 IN.
2. Measure output amplitude at pins 18, 19 and 20.
3. GTmax is defined as follows:

$$GTmax=20\log \frac{\text{Measured value (VP-P)}}{GTnor (VP-P)} \text{ (dB)}$$

**GTmin Video tone 3**

1. Input SGB (f=3MHz) from pin 34 IN and input SGS into pin 42 IN.
2. Measure output amplitude at pins 18, 19 and 20.
3. GTmin is defined as follows:

$$GTmin=20\log \frac{\text{Measured value (VP-P)}}{GTnor (VP-P)} \text{ (dB)}$$

**GT2M Video tone 4**

1. Input SGB (f=2MHz) from pin 34 IN and input SGS into pin 42 IN.
2. Measure output amplitude at pins 18, 19 and 20.
3. GT2M is defined as follows:

$$GT2M=20\log \frac{\text{Measured value (VP-P)}}{GTnor (VP-P)} \text{ (dB)}$$

**GT5M Video tone 5**

1. Input SGB (f=5MHz) from pin 34 IN and input SGS into pin 42 IN.
2. Measure output amplitude at pins 18, 19 and 20.
3. GT5M is defined as follows:

$$GT5M=20\log \frac{\text{Measured value (VP-P)}}{GTnor (VP-P)} \text{ (dB)}$$

**GYnor Contrast 1**

1. Input SGB (f=100kHz) from pin 34 IN and input SGS into pin 42 IN.
2. Measure output amplitude at pins 18, 19 and 20.

**GYmin Contrast 2**

1. Input SGB (f=100kHz) from pin 34 IN and input SGS into pin 42 IN.
2. Measure output amplitude at pins 18, 19 and 20.
3. GYmin is defined as follows:

$$GYmin=20\log \frac{\text{Measured value (VP-P)}}{GYnor (VP-P)} \text{ (dB)}$$

**Lum nor Brightness control 1, Lum max Brightness control 2,**

**Lum min Brightness control 3**

1. No signal is input. (Only SGS is input to pin 42 IN.)

2. Measure DC voltage of output at pins 18, 19 and 20 except that at blanking part.

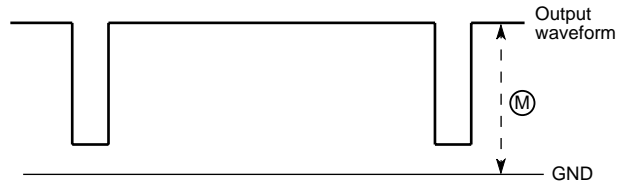

3. Y22=(Lum max)-(Lum nor), Y23=(Lum min)-(Lum nor)

**D (R) Drive R**

1. Input SGA from pin 34 IN and input SGS into pin 42 IN.
2. Measure DRmin and DRmax which are output amplitude at pins 18 at D (R) data min and D (R) data max respectively.
3. D (R) is defined as follows:

$$D (R)=20\log \frac{DRmax (VP-P)}{DRmin (VP-P)} \text{ (dB)}$$

**D (B) Drive B**

1. Input SGA from pin 34 IN and input SGS into pin 42 IN.
2. Measure DBmin and DBmax which are output amplitude at pin 20 at D (B) data min and D (B) data max respectively.
3. D (B) is defined as follows:

$$D (B)=20\log \frac{DBmax (VP-P)}{DBmin (VP-P)} \text{ (dB)}$$

**EX (R) EXT (R) I/O, EX (G) EXT (G) I/O, EX (B) EXT (B) I/O**

1. Input SGD into each of pin 30, 24, 26 and 28 and input SGS into pin 42 IN.
2. Measure output amplitude which is higher than the pedestal level at pins 18, 19 and 20. The amplitude at blanking part should not be measured.

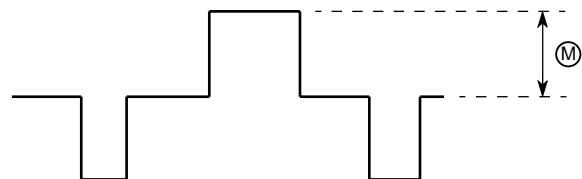

**OFRG Offset voltage R-G, OFBG Offset voltage B-G**

1. Measure DC voltage of output at pin 18, 19 and 20 except that at blanking part .
2. OFRG and OFBG are defines as follows:

OFRG=

(pin 18 Measured voltage)-(pin 19 Measured voltage) (mV)

OFBG=

(pin 20 Measured voltage)-(pin 19 Measured voltage) (mV)

VIF, SIF, VIDEO, CHROMA, DEFLECTION FOR NTSC

**R (C) Cutoff R, G (C) Cutoff G, B (C) Cutoff B**

1. Measure DC voltage of output at pin 18, 19 and 20 when R (C), G (C) and B (C) data are maximum and minimum respectively. The DC voltage at blanking part should not be measured.
2. R (C), G (C) and B (C) are defined as follows:  
R (C), G (C) and B (C)=  
(Voltage at data max.)-(Voltage at data min.) (V)

**DLFY delay time (fine)**

1. Input SGA from pin 34 IN and input SGS into pin 42 IN.
2. Measure the time lag (absolute value) between signal YDL3 and output signal at pins 18, 19 and 20.

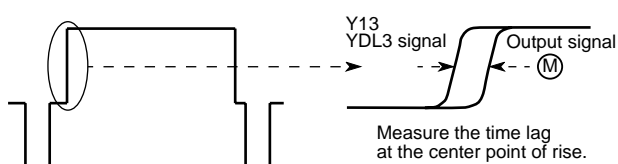

**Ccon1 Color control 1, Ccon2 Color control 2**

1. Input VS (ec=eb+100kHz) from pin 36 and input SGS into pin 42 IN.
2. Measure output amplitude at pins 18, 19 and 20 under each condition.

**VMF Video mute**

1. Input SGF from pin 34 and input SGS into pin 42 IN.
2. Measure output amplitude of the element of 3.58MHz when the mute switch is on and off. (VMFon, VMFoff)
3. VMF is defined as follows:

$$VMF=20\log \frac{VMFon (VP-P)}{VMFoff (VP-P)} \text{ (dB)}$$

**MTXB Matrix 1, MTXG Matrix 2**

1. Input VS (ec=eb+100kHz) from pin 36 and input SGS into pin 42 IN.
2. Measure output amplitude at pins 20 and 19.  
(P20=MTXB, P19=MTXG)

**MTXR Matrix 3**

1. Input VS (ec=eb+100kHz) from pin 36 and input SGS into pin 42 IN.
2. Measure output amplitude at pin 18.  
(P18=MTXR)

**OSD1 OSD speed 1, OSD2 OSD speed 2**

1. Input SGD into each of pin 30, 24, 26 and 28 and input SGS into pin 42 IN.

2. Measure rise time and fall time of the signal of output at pins 18, 19 and 20. Measurement points should be higher than the pedestal level and blanking part should not be measured.

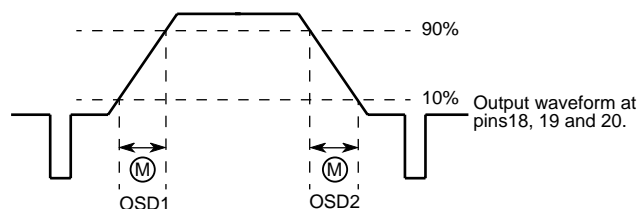

**GYmax1 Contrast 3, GYmin1 Contrast 4**

1. Input SGA from pin 34 IN and input SGS into pin 42 IN.
2. Measure output amplitude at pins 18, 19 and 20 when 2.9V and 0V are externally applied to pin 25.

**ABR Bright increase voltage**

1. Non-input.
2. Measure the voltage except for pin 19 blanking.

**BLS1 Black expansion characteristics 1,**

**BLS2 Black expansion characteristics 2,**

**BLS3 Black expansion characteristics 3**

1. Input SGC (BLS1=0.2VP-P, BLS2=0.45VP-P, BLS3=0VP-P) from pin 34 IN and input SGS into pin 42 IN.
2. With black expansion set to ON/OFF, specify the pin 19 output voltages to be VBLSON1 to 3/BVLSOFF1 to 3, respectively.
3. The standard shall be expressed by BLS1 to 3=VBLSOFF1 to 3-BVLSON1 to 3 (mVP-P).

**ABL1 ABL characteristics 1, ABL2 ABL characteristics 2**

1. Non-input.
2. When a voltage of 4.75V is applied to pin 46, measure the output voltage at pin 19 and specify the value to be ABL1.
3. When a voltage of 0V is applied to pin 46, measure the output voltage at pin 19 and specify the value to be ABL2.

**γ1 Gamma characteristics 1, γ2 Gamma characteristics 2**

1. Input SGA from pin 34 IN and input SGS into pin 42 IN.
2. When a voltage of 4.75V is applied to pin 45, measure the amplitude of pin 19 output and specify the value to be γ1.
3. When a voltage of 0V is applied to pin 45, measure the amplitude of pin 19 output and specify the value to be γ2.
4. γ1, γ2 are defined as follows:  
γ2=γ1-Measured value (mVP-P)

**ISS Sync separation input sensitivity current**

When current flows from pin 42, measure the flow current with the burst gate pulse of P8SCP eliminated.

VIF, SIF, VIDEO, CHROMA, DEFLECTION FOR NTSC

**BGP1 Burst gate pulse timing 1**

**BGP2 Burst gate pulse timing 2, BGPW Burst gate pulse width**

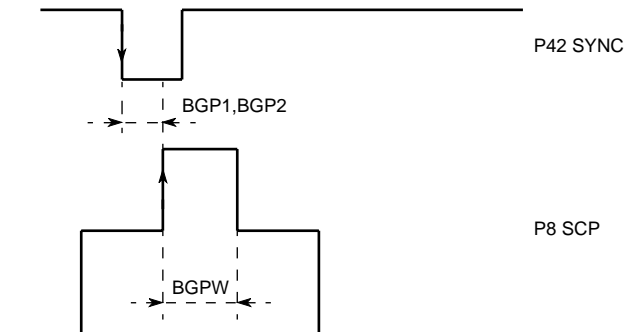

**FH Horizontal free running frequency**

Measure the output frequency at pin 10 when no signal is input .

**FPH1 Horizontal pull-in range 1**

**FPH2 Horizontal pull-in range 2**

Change the frequency of SGc and measure the frequency at the moment when the output signal at pin 10 and the input signal at pin 42 are pulled in. The horizontal pull-in range is measured by comparing with 15.734kHz.

**HPT1 Horizontal pulse timing 1**

**HPT2 Horizontal pulse timing 2**

**HPT3 Horizontal pulse timing 3**

$$HPT2 = \text{Hphase data (0)} - HPT1$$

$$HPT3 = \text{Hphase data (15)} - HPT1$$

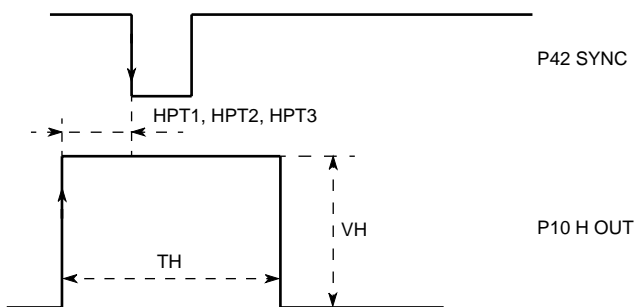

TH Horizontal pulse width, VH Horizontal pulse amplitude

**HSTO Horizontal pulse stop function**

Confirm that the horizontal output is high when the horizontal stop switch is on.

**AFCG AFC gain**

1. Measure AFC on which is the output amplitude of pin 12 when AFC switch is on and AFC off which is that when the switch is off.
2. AFCG is defined as follows:

$$AFCG = 20 \log \frac{AFC_{on} (V_{P-P})}{AFC_{off} (V_{P-P})} \text{ (dB)}$$

**FV Vertical free running frequency**

Measure the output frequency at pin 14 when no signal is input.

**SW Service SW operation**

Measure the output DC voltage at pin 14 when the service switch is on.

**FPV Vertical pull-in range**

Decrease the frequency of SGd and measure the frequency when output waveform at pin 14 is pulled in.

**VW Vertical pulse width (free running)**

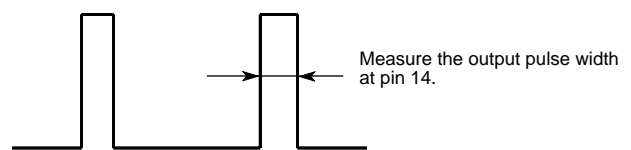

**VBLKW Vertical blanking width**

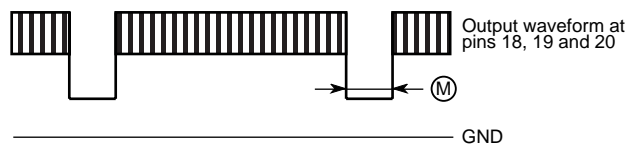

**WVSS Vertical sync.detection minimum width**

Change the input pulse width of SGd and measure the input pulse width at the moment when the output signal at pin 14 is pulled in.

**FBPI FBP inv OUT**

Measure the Hi and Lo voltages of the pin 13 output pulse.

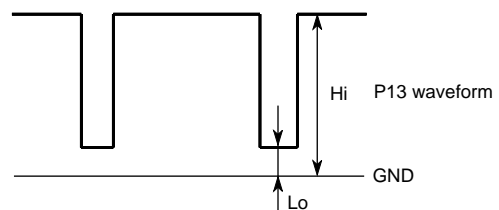



**VIF, SIF, VIDEO, CHROMA, DEFLECTION FOR NTSC**

Note: The timing and pulse width of the horizontal blanking pulse should be as shown in the following figure by adjusting the variable resistor of the single shot multi vibrator.

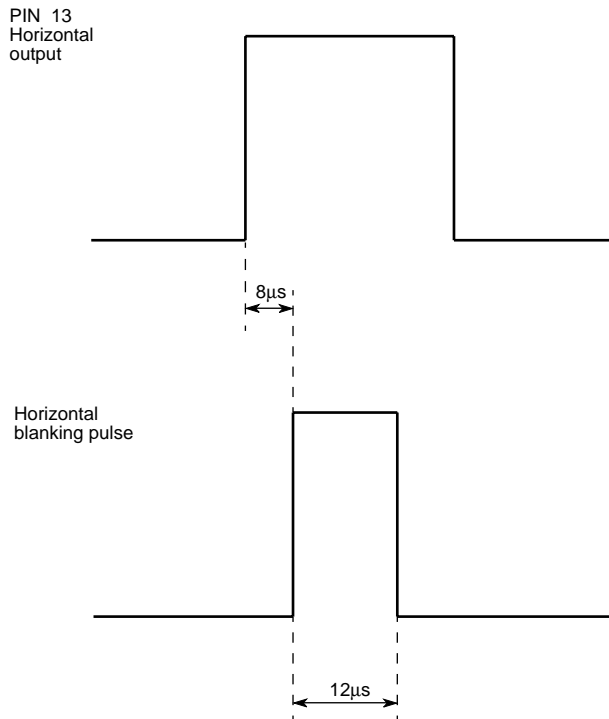

The variable resistor at pin 15 of the TTL IC, M74LS221P, is used to fix the timing at  $8\mu\text{s}$  and that at pin 7 is used to fix the pulse width at  $12\mu\text{s}$ .

\*Coil adjustment

VCO COIL

1. Input CW ( $f_0=45.75\text{MHz}$ ,  $V_i=90\text{dB}\mu$ ) to input pin A.
2. Set the DC voltage at pin 58 (AFT OUT) to  $1/2V_{cc}$  (4.0V) by adjusting VCO coil.

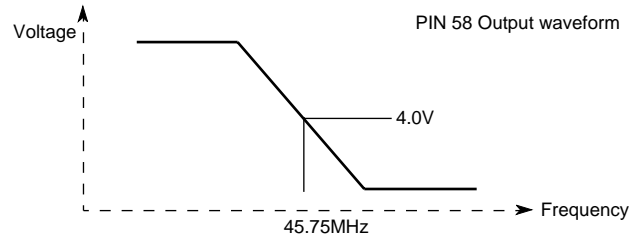

Note: VCO coil should always be adjusted as above before using this IC.

# M52775FP

## VIF, SIF, VIDEO, CHROMA, DEFLECTION FOR NTSC

### I<sup>2</sup>C BUS FORMATS

(1) Slave address:     A6  A5  A4  A3  A2  A1  A0  R/W  
                           1  0  1  1  1  0  1  0     (=BAH)

(2) Slave address format:

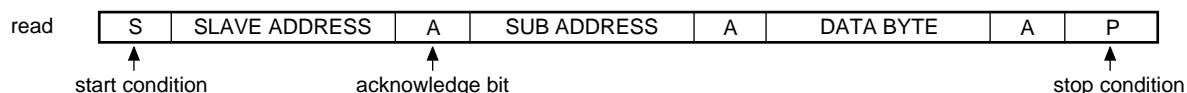

(3) Sub address byte and data byte format:

**read**

	No.	Functions	BIT	SUB ADD	Data byte							
					D7	D6	D5	D4	D3	D2	D1	D0
VIF/SIF	1	DELAY ADJ	6	00H	0	–	A05	A04	A03	A02	A01	A00
	4	AUDIO SW	1	01H		AUDIO SW						
	6	DEFEAT	1	04H		DEFEAT						
	7	AUDIO ATT	7	03H	0	A36	A35	A34	A33	A32	A31	A30
VIDEO	8	VIDEO TONE	6	04H	0	–	A45	A44	A43	A42	A41	A40
	9	CONTRAST	7	05H	0	A56	A55	A54	A53	A52	A51	A50
	10	DL time ADJ	2	06H	0	–	0	–	–	–	A61	A60
	25	DL fine ADJ.	1	02H							DLfine	
	11	TV/EXT SW	1	06H						TV/EXT		
	12	Y/C SW	1	06H					Y/C IN			
	13	Black Stretch	1	06H				black				
	14	TRAP SW	1	02H			TRAP					
	38	TRAP ADJ 1	1	10H			TADJ1					
	40	TRAP ADJ 2	1	02H				TADJ2				
CHROMA	36	VIDEO MUTE	1	0BH		V MUTE						
	15	TINT	7	07H	0	A76	A75	A74	A73	A72	A71	A70
	16	COLOR	7	08H	0	A86	A85	A84	A83	A82	A81	A80
INTER-FACE	26	KILLER OFF	1	09H						KILL OFF		
	19	BRIGHT	7	0AH	0	AA6	AA5	AA4	AA3	AA2	AA1	AA0
	20	DRIVE (R)	6	0BH	0	–	AB5	AB4	AB3	AB2	AB1	AB0
	21	DRIVE (B)	6	0CH	0	0	AC5	AC4	AC3	AC2	AC1	AC0
	22	CUT OFF (R)	8	0DH	AD7	AD6	AD5	AD4	AD3	AD2	AD1	AD0
	23	CUT OFF (G)	8	0EH	AE7	AE6	AE5	AE4	AE3	AE2	AE1	AE0
	24	CUT OFF (B)	8	0FH	AF7	AF6	AF5	AF4	AF3	AF2	AF1	A100
DEFLEC-TION	27	AFC-2 H PHASE	4	09H	0	A96	A95	A94	A93	–	–	–
	33	SERVICE SW	1	13H					Service SW			
	34	H STOP	1	13H				H STOP				
	35	AFC GAIN	1	13H			AFC GAIN					
	42	H fo ADJ	1	06H		HADJ						
	32	2 WINDOW SW	1	12H			2WS					

VIF, SIF, VIDEO, CHROMA, DEFLECTION FOR NTSC

**DATA BYTE CONDITIONS AT SW**

	Functions	Data	Condition	Initial condition	
IF	AUDIO SW	AUDIO SW	0	TV	TV
			1	EXT	
	DEFEAT	DEFEAT	0	OFF	OFF
			1	ON	
VIDEO	DL time ADJ	A61, A60	0 0	220nsec	420nsec
			0 1	320nsec	
			1 0	420nsec	
			1 1	420nsec	
	DL time fine ADJ	DL fine	0	+50nsec	+0nsec
			1	+0nsec	
	TV/EXT	TV/EXT	0	TV	TV
			1	EXT	
	Y/C IN	Y/C IN	0	Y/C	Y/C
			1	TV or EXT	
	black stretch	black	0	OFF	OFF
			1	ON	
	TRAP SW	TRAP	0	OFF	OFF
			1	ON	
	TRAP fine adj. 1	TADJ1	0	OFF	OFF
			1	ON	
TRAP fine adj. 2	TADJ2	0	OFF	ON	
		1	ON		
VIDEO MUTE	V MUTE	0	OFF	OFF	
		1	ON		
CHROMA	KILLER OFF		0	Normal	Normal
			1	KILLER OFF	
DEFLECTION	Service SW	Service SW	0	Normal mode	Normal mode
			1	Service mode	
	H STOP	H STOP	0	H out	H out
			1	H stop	
	AFC GAIN	AFC GAIN	0	NORMAL	NORMAL
			1	HIGH	
	H fo ADJ	H ADJ	0	fo down	fo down
			1	fo up	
2 WINDOW	2 WINDOW SW	0	Normal	Normal	
		1	2 WINDOW		

**M52775FP**

VIF, SIF, VIDEO, CHROMA, DEFLECTION FOR NTSC

**DATA BYTE CONDITIONS AT D/A**

	Functions	BIT	Data	Condition	Initial condition
IF	DELAY ADJ	6	0 to 63		32
	AUDIO ATT	7	0 to 127		32
VIDEO	VIDEO TONE	6	0 to 63		0
	contrast cont	7	0 to 127		32
CHROMA	tint cont	7	0 to 127		64
	color cont	7	0 to 127		32
INTERFACE	bright cont	7	0 to 127		32
	drive (R)	6	0 to 63		32
	drive (B)	6	0 to 63		32
	cut off (R)	8	0 to 255		128
	cut off (G)	8	0 to 255		128
	cut off (B)	8	0 to 255		128
DEFLECTION	AFC-2 H phase	4	0 to 15		10

**I<sup>2</sup>C BUS CONTROL SECTION SDA, SCL CHARACTERISTICS**

Symbol	Parameter	Limits		Unit
		Min.	Max.	
V <sub>IL</sub>	Min. input low voltage	-0.5	1.5	V
V <sub>IH</sub>	Max. input high voltage	3.0	5.5	V
f <sub>SCL</sub>	SCL clock frequency	0.0	100	kHz
t <sub>BUF</sub>	Time the bus must be free before a new transmission can start	4.7	–	μs
t <sub>HD:STA</sub>	Hold time start condition. After this period the first clock pulse is generated	4.0	–	μs
t <sub>LOW</sub>	The low period of the clock	4.7	–	μs
t <sub>HIGH</sub>	The high period of the clock	4.0	–	μs
t <sub>SU:STA</sub>	Setup time for start condition (Only relevant for a repeated start condition)	4.7	–	μs
t <sub>HD:DAT</sub>	Hold time DATA	0.0	–	μs
t <sub>SU:DAT</sub>	Set-up time DATA	250	–	ns
t <sub>r</sub>	Rise time of both SDA and SCL lines	–	1000	ns
t <sub>f</sub>	Fall time of both SDA and SCL lines	–	300	ns
t <sub>SU:STO</sub>	Set-up time for stop condition	4.0	–	μs

**TIMING DIAGRAM**

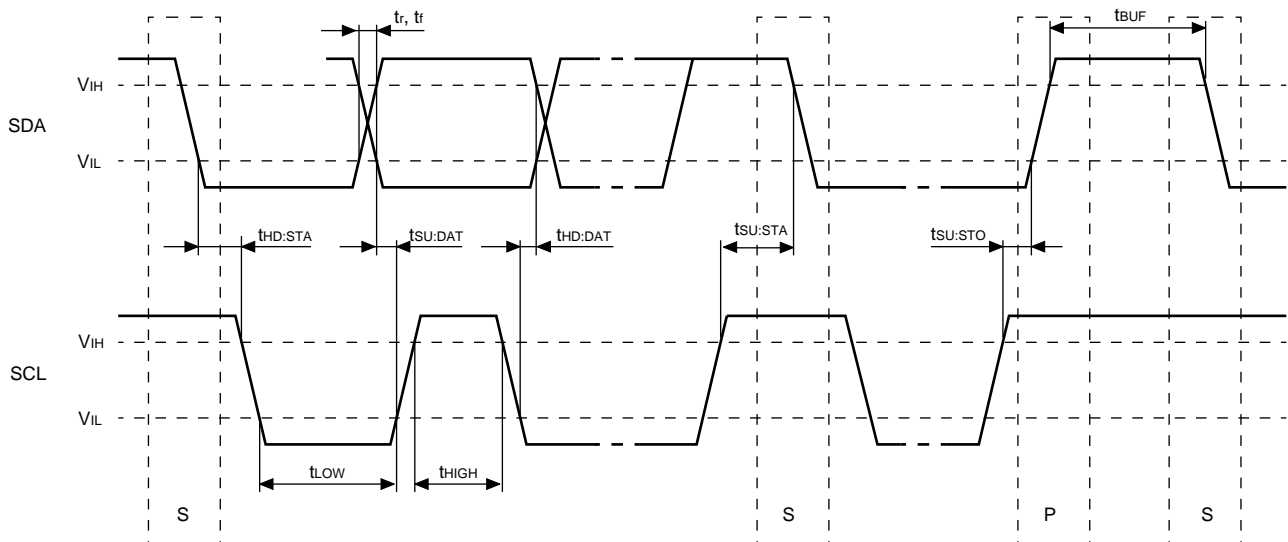

VIF, SIF, VIDEO, CHROMA, DEFLECTION FOR NTSC

**INPUT SIGNAL  
VIF/SIF**

SG No.	Signals (50Ω termination)
1	f <sub>0</sub> =45.75MHz 90dBμ fm=20kHz AM77.8%
3	f <sub>0</sub> =45.75MHz 90dBμ CW
4	f <sub>1</sub> =45.75MHz 90dBμ CW (Mixed signal) f <sub>2</sub> =44±5MHz 70dBμ CW (Mixed signal)
5	f <sub>0</sub> =45.75MHz variable fm=20kHz AM77.8%
6	f <sub>0</sub> =45.75MHz fm=20kHz AM16% level variable
7	f <sub>0</sub> =45.75MHz 80dBμ CW
8	f <sub>0</sub> =45.75MHz 110dBμ CW
9	f <sub>0</sub> =45.75±5MHz 90dBμ CW
10	f <sub>0</sub> =44.75MHz 90dBμ CW
11	f <sub>0</sub> =46.75MHz 90dBμ CW
12	f <sub>1</sub> =45.75MHz 90dBμ CW (Mixed signal) f <sub>2</sub> =41.25MHz 80dBμ CW (Mixed signal) f <sub>3</sub> =42.17MHz 80dBμ CW (Mixed signal)
13	f <sub>0</sub> =45.75MHz standard 10-step modulation Sync ratio 28.6% AM=87.5%video modulation Sync chip level 90dBμ
14	f <sub>0</sub> =45.75MHz 93dBμ CW
15	f <sub>0</sub> =45.75MHz 73dBμ CW
16	f <sub>0</sub> =4.5MHz 100dBμ fm=400Hz FM±25kHz dev
17	f <sub>0</sub> =4.5MHz 50dBμ CW
20	f <sub>0</sub> =4.5MHz 100dBμ fm=400Hz AM30%
22	f=1kHz 1V <sub>P-P</sub> CW

**INPUT SIGNAL PARAMETERS INCLUDING  
INPUT SIGNALS**

1. Input signal name is two alphanumeric characters.

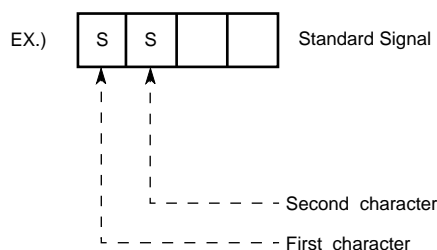

First character: Standard=S, Nonstandard=V  
(Modified parts should be specified.)

Second character: Meaning of signal

2. Structure of input color signal

The following figure shows the structure of color signal.

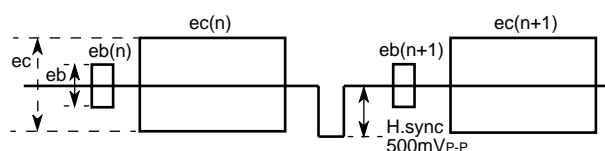

1) When S (standard) is used as the first character, the standard color bar signal of each system is applied. H.sync should be added for input clamp.

2) Amplitude and frequency of burst are represented as ed. In case of standard signal, the amplitude is 285mV<sub>P-P</sub>.

3) Amplitude and frequency of chroma are represented as ec. In case of standard signal, the amplitude is 570mV<sub>P-P</sub> and the frequency is 3.579545MHz.

VIF, SIF, VIDEO, CHROMA, DEFLECTION FOR NTSC

**VIDEO/INTERFACE**

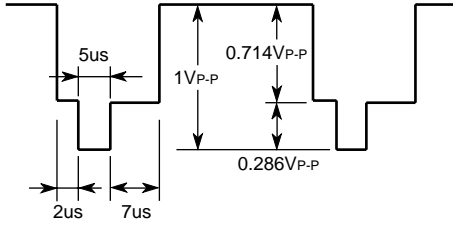
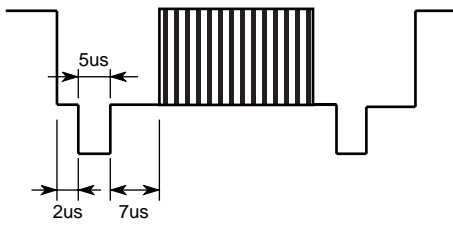
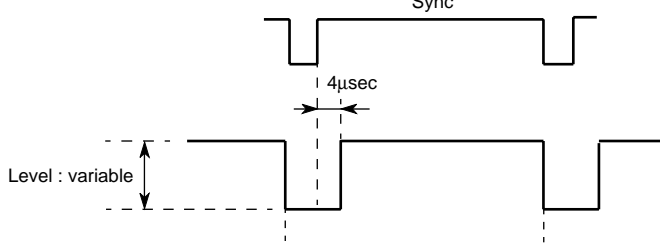
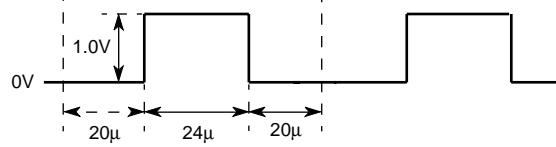
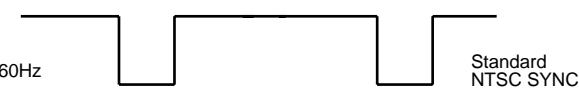
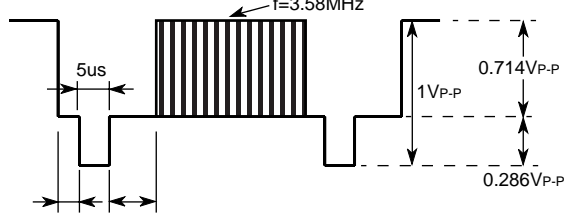
SG No.	Signal (50Ω termination)
SGA	<p>NTSC system APL100% standard video signal should be input as sync separation input as shown in the figure. The vertical signal should be interlaced at 60Hz.</p> 
SGB	<p>The frequency and amplitude of signal Lumi can be changed by signal SGA. The typical amplitude is 0.714mVp-p.</p> 
SGC	 <p>Level : variable</p>
SGD	 <p>0V</p> <p>1.0V</p> <p>20µ</p> <p>24µ</p> <p>20µ</p>
SGS	<p>Level : variable typ=0.3Vp-p H=15.734kHz, V=60Hz</p>  <p>Standard NTSC SYNC</p>
SGF	 <p>f=3.58MHz</p> <p>5µs</p> <p>2µs</p> <p>7µs</p> <p>1Vp-p</p> <p>0.714Vp-p</p> <p>0.286Vp-p</p>

VIF, SIF, VIDEO, CHROMA, DEFLECTION FOR NTSC

**DEFLECTION**

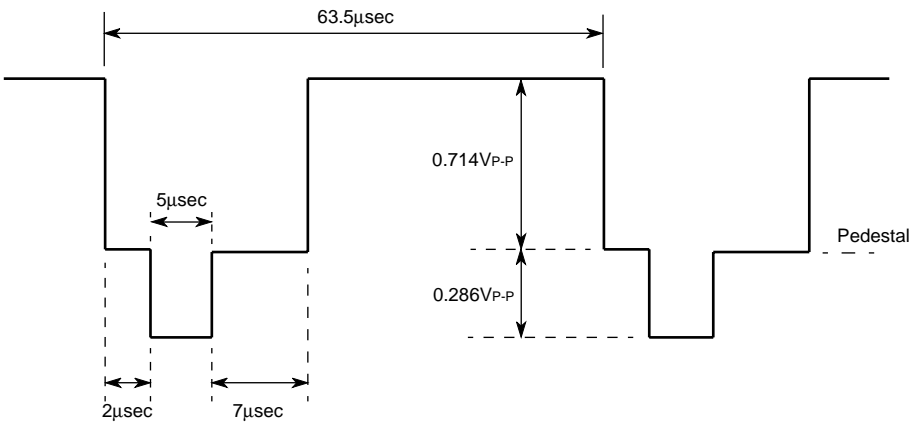
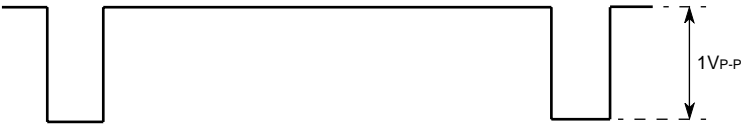
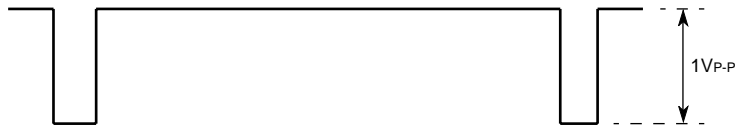
SG No.	Signal (50Ω termination)
SGa	<p>The input signal should be NTSC system APL-variable video signal. Vertical should be interlaced at 60Hz.</p>  <p>The diagram shows a video signal waveform. Key parameters are:         <ul style="list-style-type: none"> <li>63.5μsec: Total duration of the main signal pulse.</li> <li>0.714V<sub>P-P</sub>: Peak-to-peak voltage of the main signal pulse.</li> <li>0.286V<sub>P-P</sub>: Peak-to-peak voltage of the pedestal signal.</li> <li>5μsec: Duration of the pedestal pulse.</li> <li>2μsec: Duration of the leading edge of the pedestal pulse.</li> <li>7μsec: Duration of the trailing edge of the pedestal pulse.</li> <li>Pedestal: A lower-level signal component.</li> </ul> </p>
SGb	<p>Duty90% Frequency:variable Level:variable (Typ. :1V<sub>P-P</sub>)</p>  <p>The diagram shows a square wave pulse with a 90% duty cycle. The peak-to-peak voltage is 1V<sub>P-P</sub>.</p>
SGc	<p>Duty95% Frequency:variable Level:variable (Typ. :1V<sub>P-P</sub>) Duty: variable (95%)</p>  <p>The diagram shows a square wave pulse with a 95% duty cycle. The peak-to-peak voltage is 1V<sub>P-P</sub>.</p>

# M52775FP

VIF, SIF, VIDEO, CHROMA, DEFLECTION FOR NTSC

## TEST CIRCUIT

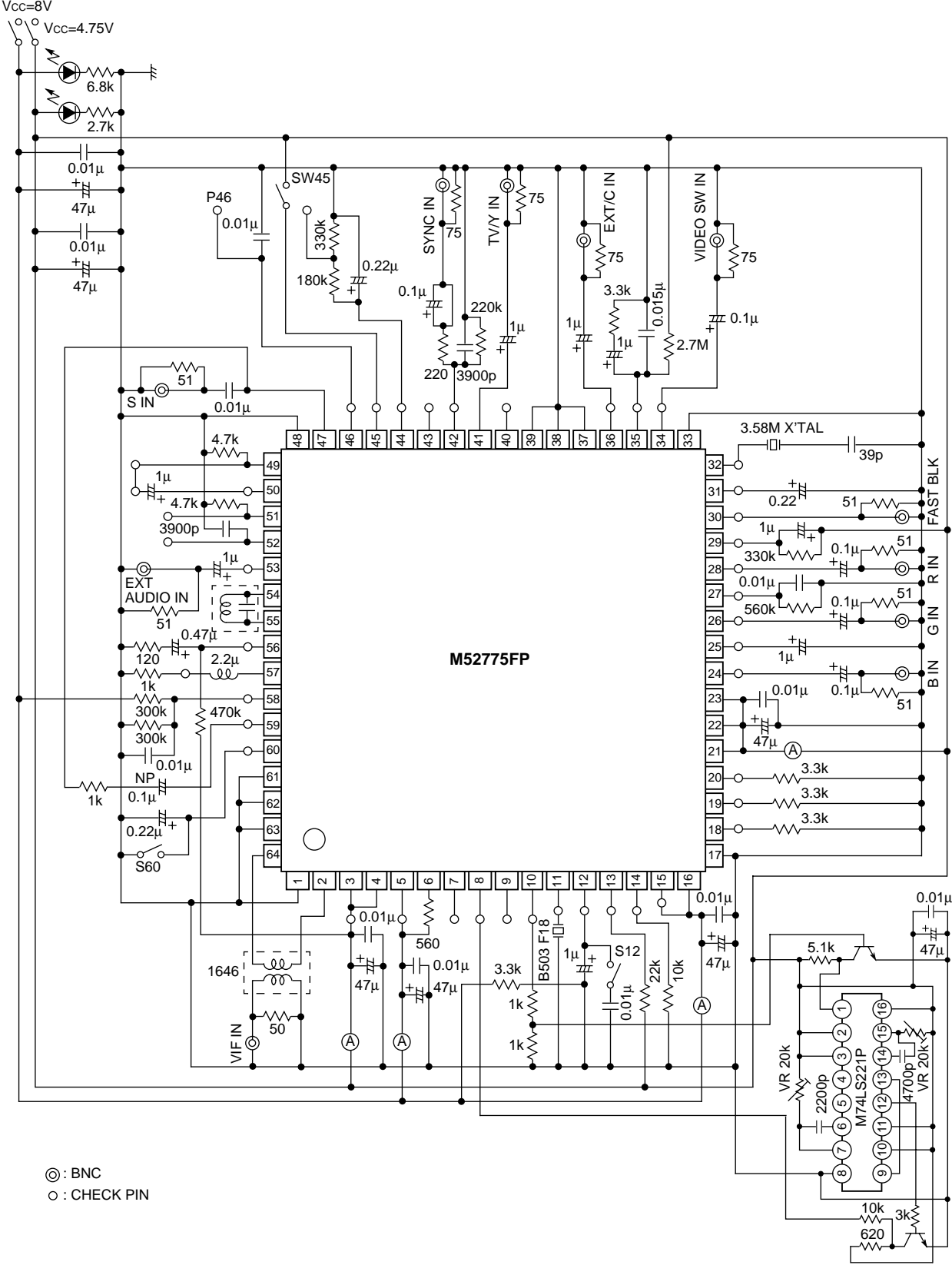

Units Resistance : Ω  
Capacitance : F



**TYPICAL CHARACTERISTICS**

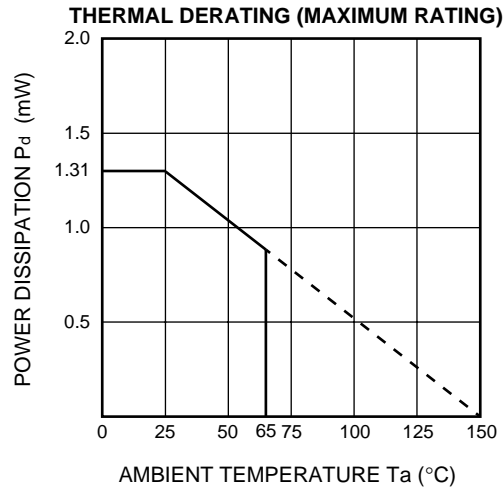

APPLICATION EXAMPLE

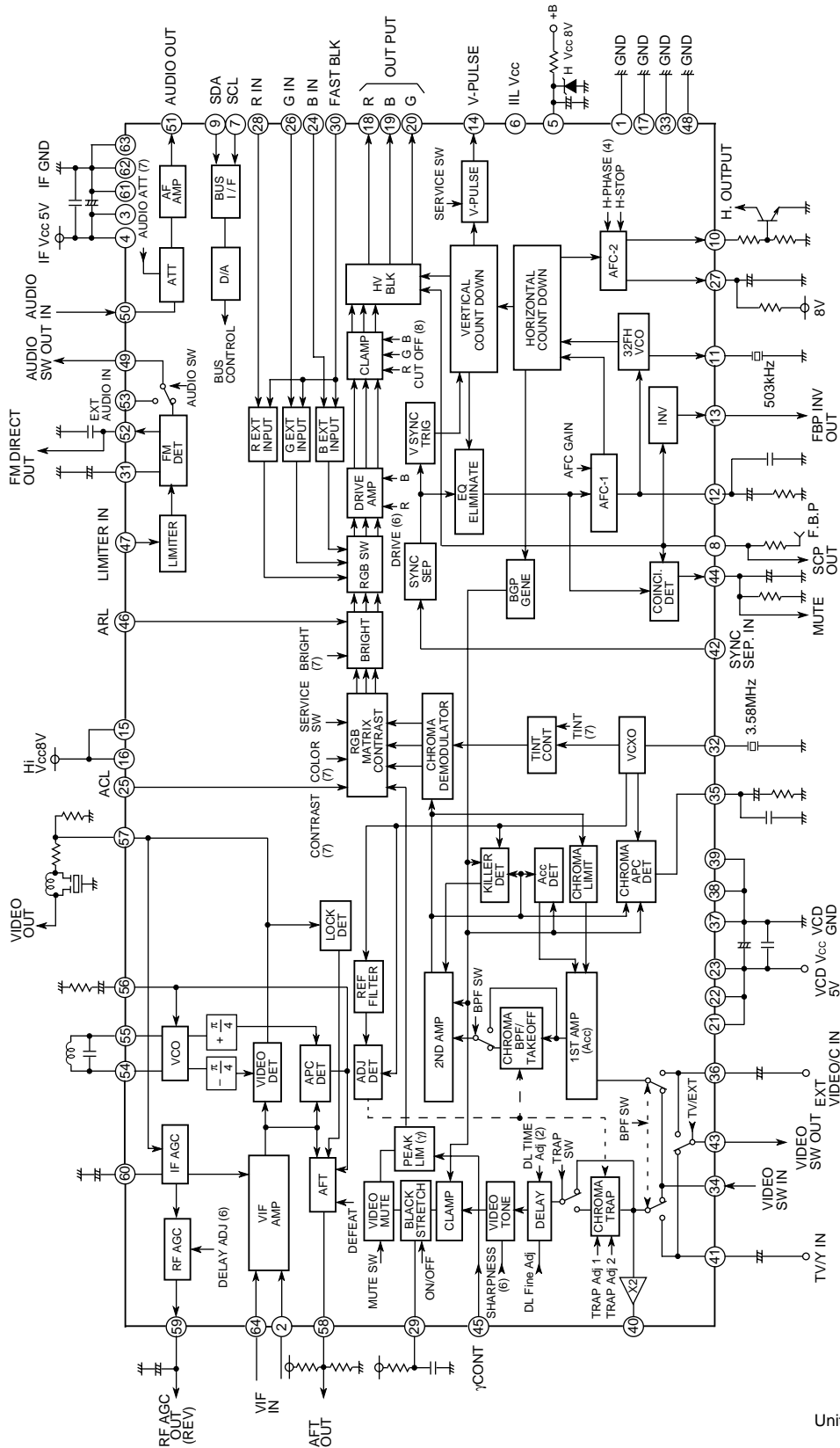

Units Resistance :  $\Omega$   
Capacitance : F

**DESCRIPTION OF PIN**

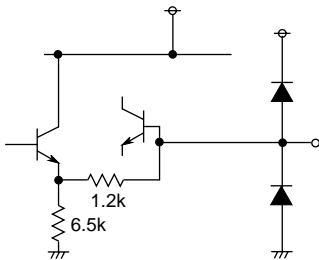
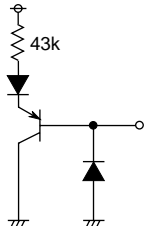
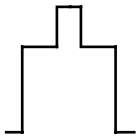
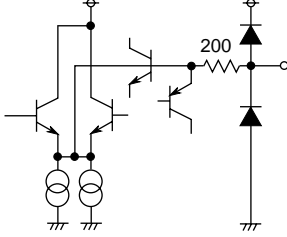
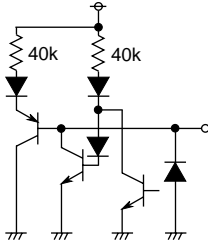
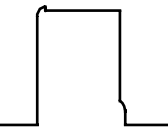
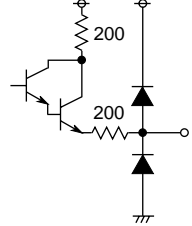
Pin No.	Name	Pin wave	Peripheral circuit of pins	Pin voltage (V)	Remark
1	GND	—	—	—	
2 64	IF IN	—		1.45	
3 4	IF Vcc1 IF Vcc2	—	—	4.75	
5	H Vcc	—	—	8.0	
6	ILL Vcc	—	—	1.5	
7	SCL	—		—	
8	FBP IN			4.20 3.1 1.55	BGP HBLK VBLK
9	SDA	—		—	
10	H OUT			3.70 0	H L

VIF, SIF, VIDEO, CHROMA, DEFLECTION FOR NTSC

**DESCRIPTION OF PIN** (cont.)

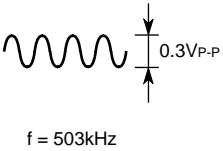
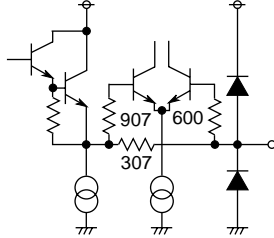
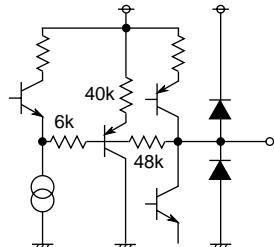
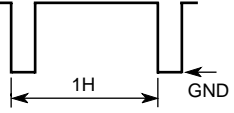
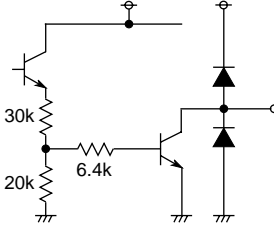
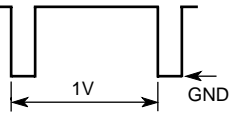
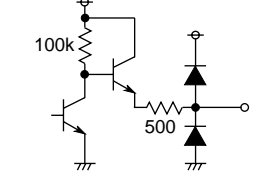
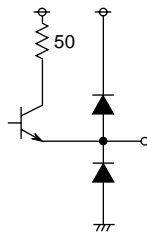
Pin No.	Name	Pin wave	Peripheral circuit of pins	Pin voltage (V)	Remark
11	H OSC	 <p>0.3V<sub>p-p</sub> f = 503kHz</p>		3.2	
12	AFC1 FILTER	-		5.1	
13	FBP INV OUT	 <p>1H GND</p>		8.0 0.2	H L
14	V PULSE	 <p>1V GND</p>		6.5 0	H L
15	Hi Vcc1	-	-	8.0	
16	Hi Vcc2	-	-	8.0	
17	GND	-	-	0	
18 19 20	R OUT G OUT B OUT	-		2.5 0	H L
21 22 23	VCD Vcc1 VCD Vcc2 VCD Vcc3	-	-	4.75	

**M52775FP**

VIF, SIF, VIDEO, CHROMA, DEFLECTION FOR NTSC

**DESCRIPTION OF PIN** (cont.)

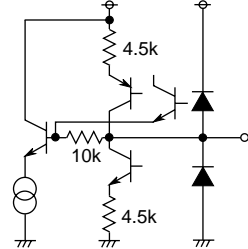
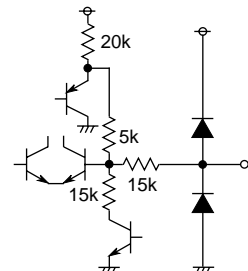
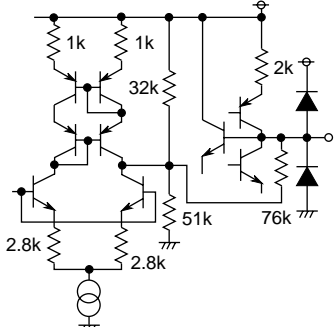
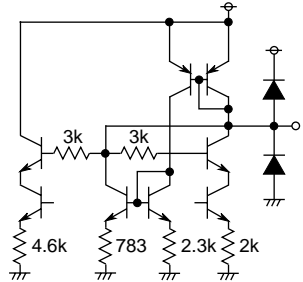
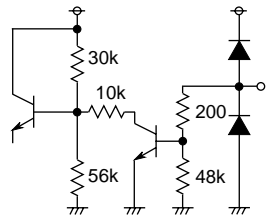
Pin No.	Name	Pin wave	Peripheral circuit of pins	Pin voltage (V)	Remark
24 26 28	B IN G IN R IN	-		2.6	
25	CONTRAST CONT.	-		3.1	
27	AFC2 FILTER	-		5.4	
29	BLACK PEAK HOLD	-		2.2	
30	FAST BLK	-		0	

**M52775FP**

VIF, SIF, VIDEO, CHROMA, DEFLECTION FOR NTSC

**DESCRIPTION OF PIN** (cont.)

Pin No.	Name	Pin wave	Peripheral circuit of pins	Pin voltage (V)	Remark
31	AUDIO BYPASS	-		2.7	
32	X-TAL 3.58	 $f = 3.58\text{MHz}$ 0.1V <sub>P-P</sub>		2.7	
33	GND	-	-	0	
34	VIDEO SW IN	-		2.1	
35	CHROMA APC FILTER	-		2.9	
36	EXT/C IN	-		2.0	
37 38 39	VCD GND	-	-	0	

**M52775FP**

VIF, SIF, VIDEO, CHROMA, DEFLECTION FOR NTSC

**DESCRIPTION OF PIN** (cont.)

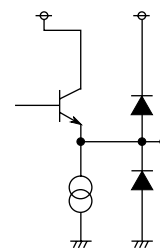
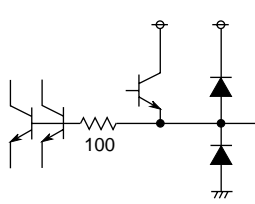
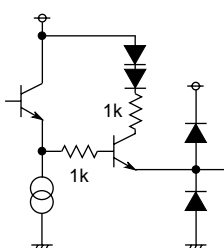
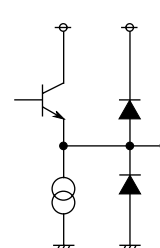
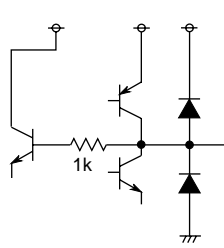
Pin No.	Name	Pin wave	Peripheral circuit of pins	Pin voltage (V)	Remark
40	Y SW OUT	-		2.0	
41	TV/Y IN	-		2.0	
42	SYNC SEP IN	-		5.9	
43	VIDEOSW OUT	-		1.4	
44	COINCI- DENCE	-		0.2	

**M52775FP**

VIF, SIF, VIDEO, CHROMA, DEFLECTION FOR NTSC

**DESCRIPTION OF PIN** (cont.)

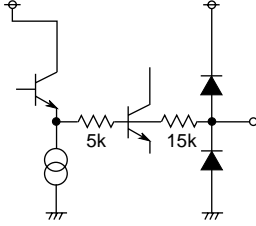
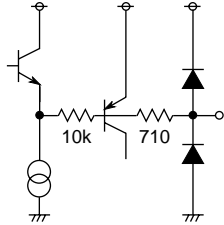
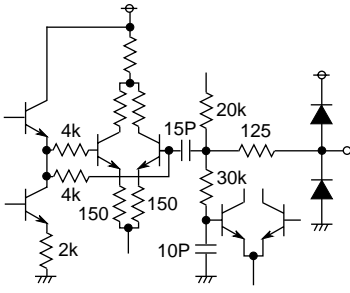
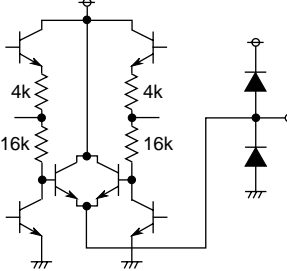
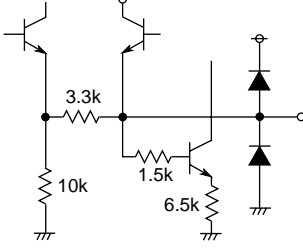
Pin No.	Name	Pin wave	Peripheral circuit of pins	Pin voltage (V)	Remark
45	$\gamma$ -CONT	-		3.0	
46	ABL	-		2.2	
47	LIMITER IN	-		1.9	
48	GND	-	-	0	
49	AUDIO SW OUT	-		2.4	
50	AUDIO IN	-		2.4	



VIF, SIF, VIDEO, CHROMA, DEFLECTION FOR NTSC

**DESCRIPTION OF PIN** (cont.)

Pin No.	Name	Pin wave	Peripheral circuit of pins	Pin voltage (V)	Remark
51	AUDIO OUT	-		3.3	
52	FM DIRECT OUT	-		2.4	
53	EXT AUDIO IN	-		1.9	
54 55	VCO	 $f = 45.75\text{MHz}$ 0.28V <sub>P-P</sub>		4.0	
56	VIDEO APC FILTER	-		2.6	

**M52775FP**

VIF, SIF, VIDEO, CHROMA, DEFLECTION FOR NTSC

**DESCRIPTION OF PIN** (cont.)

Pin No.	Name	Pin wave	Peripheral circuit of pins	Pin voltage (V)	Remark
57	VIDEO OUT	-		3.6	
58	AFT OUT	-		4.0	
59	RF AGC OUT	-		7.7	
60	IF AGC FILTER	-		4.2	
61 62 63	IF GND	-	-	0	