

# M/A-COM PCS CDMA LNA / Downconverter 1.8—2.0 GHz

## Features

- High Integrated LNA and Downconverter
- Operates over 2.7 V to 5V Supply Voltage
- Low Noise Figure < 2.7 dB
- High Input Intercept Point -12 dBm
- Optional Control of LNA IP<sub>3</sub>
- Low LO Drive Level -10 dBm
- Operates in US and Korean PCS Bands
- Miniature TSSOP-16 Plastic Package

## Description

M/A-COM's MD59-0021 is a fully integrated downconverter IC with LNA, RF amplifier, downconverting mixer, IF amplifier and LO buffer amplifier in a miniature TSSOP-16 plastic package with exposed metal lead frame backside for improved high frequency grounding.

The MD59-0021 is ideally suited for CDMA handset applications where wide dynamic range and low power consumption are important receiver requirements.

The MD59-0021 is fabricated using a M/A-COM's 0.5 micron low noise E/D GaAs MESFET process. The process features full passivation for increased performance and reliability.

## TSSOP-16 Plastic Package<sup>1</sup>

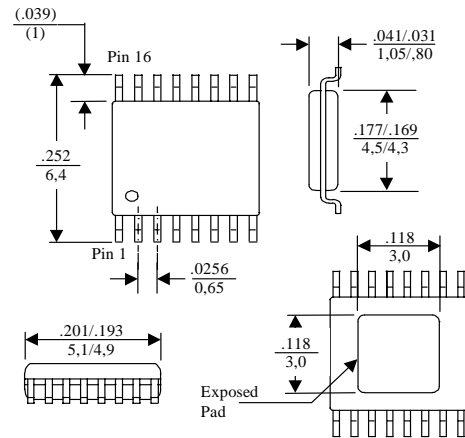

1. Dimensions are: in / mm

## Ordering Information

| Part Number  | Package                            |
|--------------|------------------------------------|
| MD59-0021TR  | Forward Tape and Reel <sup>1</sup> |
| MD59-0021RTR | Reverse Tape and Reel <sup>1</sup> |
| MD59-0021SMB | Sample Board                       |

1. If specific reel size is required, consult factory for part number assignment.

## Electrical Specifications T<sub>A</sub> = 25°C, V<sub>DD</sub> = 3.0V, RF = 1.9 GHz, LO = 1.69 GHz

| Parameter                                 | Test Conditions                   | Units | Min. | Typ. | Max. |
|---|-----------------------------------|-------|------|------|------|
| <b>Low Noise Amplifier</b>                |                                   |       |      |      |      |
| Gain                                      | Frequency = 1.9 GHz               | dB    |      | 14   |      |
| Noise Figure                              |                                   | dB    |      | 1.8  |      |
| VSWR In/Out                               |                                   |       |      | 2:1  |      |
| Input IP <sub>3</sub>                     |                                   | dBm   |      | +6   |      |
| I <sub>DD</sub>                           |                                   | mA    |      | 13   |      |
| <b>Complete DownConverter<sup>1</sup></b> |                                   |       |      |      |      |
| Conversion Gain                           |                                   | dB    |      | 22.5 | 25.4 |
| Noise Figure                              | RF = 1.9 GHz                      | dB    |      | 2.7  |      |
| Input IP <sub>3</sub>                     | LO = 1.69 GHz, LO Level = -10 dBm | dBm   |      | -12  |      |
| LO-to-RF Isolation                        |                                   | dB    |      | 50   |      |
| LO-to-IF Isolation                        |                                   | dB    |      | 24   |      |
| I <sub>DD</sub>                           | IF = 210 MHz                      | mA    |      | 32   |      |

1. Complete downconverter measurements taken with 3 dB pad between LNA output and RFA input.

Specifications subject to change without notice.

V 2.0

- North America: Tel. (800) 366-2266, Fax (800) 618-8883
- Asia/Pacific: Tel. +81-44-844-8296, Fax +81-44-844-8298
- Europe: Tel. +44 (1344) 869 595, Fax +44 (1344) 300 020

Visit [www.macom.com](http://www.macom.com) for additional data sheets and product information.

tyco / Electronics

M/A-COM

**Pin Configuration**

| PIN No. | PIN                   | Description  |
|---------|-----------------------|--|
| 1       | LO V <sub>DD</sub>    | LO Amplifier Supply Voltage. RF bypassing required.  |
| 2       | LO In                 | Local Oscillator Input (-10 to -7 dBm) (DC blocked)  |
| 3       | GND                   | DC and RF ground   |
| 4       | IF Out                | IF Output and Downconverter - must be externally matched to input impedance of IF Filter.                          |
| 5       | IF Match              | Matching between I FA and Mixer - requires an inductor to ground.  |
| 6       | GND                   | DC and RF ground   |
| 7       | LNA V <sub>DD</sub> 1 | LNA Stage 1 supply voltage. RF bypassing required.   |
| 8       | LNA In                | RF Input to LNA. External matching required.   |
| 9       | LNA SRC               | Source of LNA output stage FET. RF bypassing required. Off-chip resistor may be used to increase IP <sub>3</sub> . |
| 10      | LNA Out               | 50Ω Output of LNA. (DC Blocked)  |
| 11      | LNA V <sub>DD</sub> 2 | LNA Stage 2 supply voltage. RF bypassing required.   |
| 12      | GND                   | DC and RF ground.  |
| 13      | IF BYP                | IF Bypass of Mixer. Required DC block and RF/IF ground.  |
| 14      | GND                   | DC and RF ground   |
| 15      | RFA V <sub>DD</sub>   | RFA supply voltage. RF bypassing required.   |
| 16      | RFA In                | 50Ω Input of RFA. (DC blocking required)   |

**Block Diagrams**

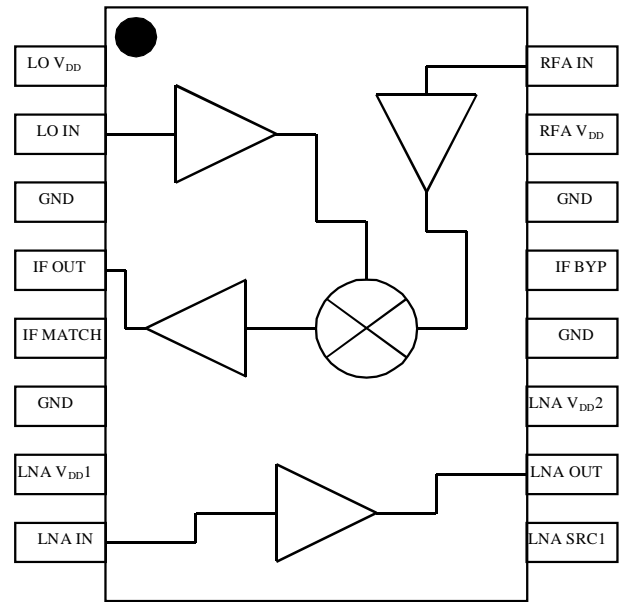

**Sample Board Schematic**

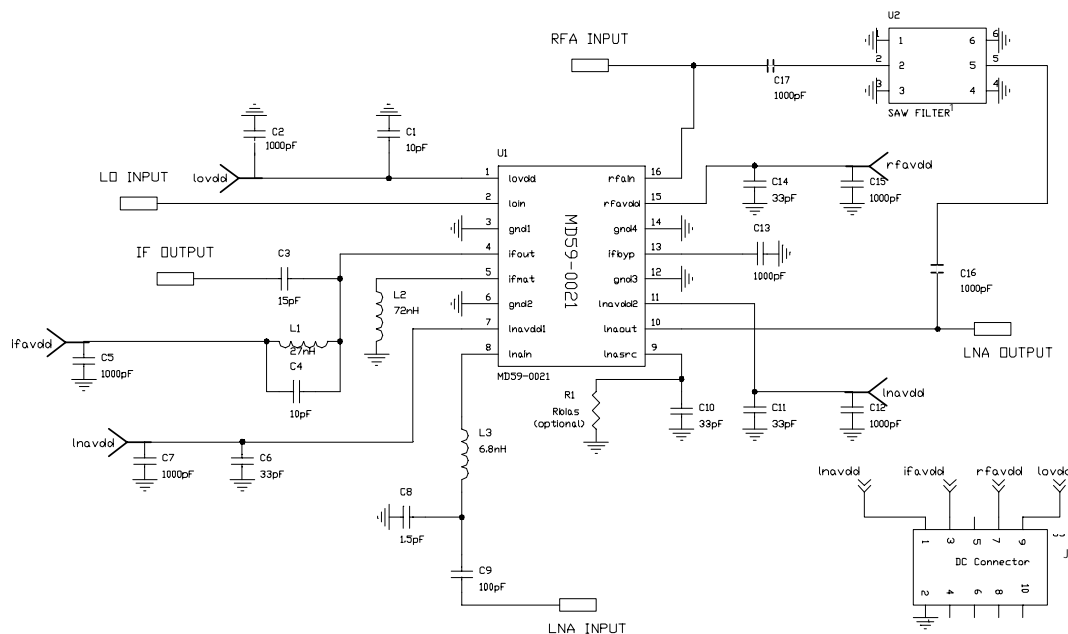

1. Saw filter characteristics to be determined by customer, depending on band of operation. Sample boards are supplied with 3 dB pi pad installed in place of saw filter, to emulate typical worst case loss. Data supplied with sample board is measured over US PCS1900 Rx Band.

Specifications subject to change without notice.

V 2.0

**North America:** Tel. (800) 366-2266, Fax (800) 618-8883  
**Asia/Pacific:** Tel.+81-44-844-8296, Fax +81-44-844-8298  
**Europe:** Tel. +44 (1344) 869 595, Fax+44 (1344) 300 020

Visit [www.macom.com](http://www.macom.com) for additional data sheets and product information.



## External Circuitry Parts List

| Ref. Designation              | Value      | Purpose   |
|-------------------------------|------------|---|
| C6, C10, C11, C14             | 33 pF      | RF Bypass   |
| C2, C5, C7, C12, C13, C15-C17 | 1000 pF    | RF / IF Bypass                                    |
| C3                            | 15 pF      | IF Matching                                       |
| C1, C4                        | 10 pF      | Bypass, IF Matching                               |
| C8                            | 1.5 pF     | LNA Input Matching                                |
| C9                            | 100 pF     | RF Bypass   |
| L1                            | 27 nH      | IF Matching                                       |
| L2                            | 72 nH      | IF Amplifier Input Matching                       |
| L3                            | 6.8 nH     | LNA Input Matching                                |
| R1                            | $R_{bias}$ | Optional resistor to increase bias current in LNA |
| U1                            |            | MD59-00021 LNA/Downconverter                      |
| U2                            | Saw Filter | Filter TX signals and image                       |
| J1                            | DC Connect | 10 PIN DC Connector                               |

## Operating Instructions

The MD59-0021 is a highly integrated MMIC downconverter for the 1.8-2 GHz PCS band. The downconverter provides exceptional RF performance while consuming low DC current and is packaged in a low cost plastic package. It is ideal for light weight battery operated portable radio systems.

The receive chain consists of an LNA, RFA, balanced mixer and single-ended IF output buffer amplifier as shown in the block diagram. Surface mount resistors, inductors and capacitors are used in conjunction with the IC for optimum performance, tunability and ease of use. A schematic showing the IC and required external components is shown on the previous page.

The input of the LNA is matched externally with a series inductor (L3) and a shunt capacitor (C8) to provide a low loss match to the optimum noise impedance in the band of interest. A high Q inductor such as Coilcraft's 0603CS series must be used if the specified noise figures are to be achieved. The series capacitor C9 is a DC blocking capacitor whose value is not critical (it should be  $\geq 100\text{pF}$ ). The LNA is nominally biased with 13 mA to give an input IP3 of +6 dBm. An external resistor R1, may be used to increase the LNA bias current and thus increase the IP3. An external image reject filter is required between the LNA output and RFA input to prevent downconversion of noise at the image frequency to the IF. This filter should have a 50 $\Omega$  input and output impedance.

The mixer is a balanced resistive FET mixer which provides exceptional linearity and isolation with low loss and no DC current. An off-chip inductor, L, is required to match the output of the mixer to the input of the IF buffer amplifier.

## Recommended PCB Configuration

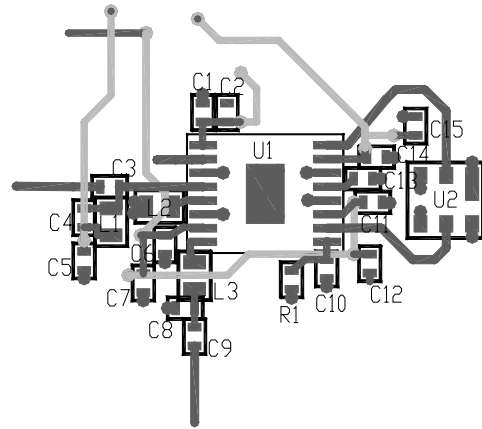

## Cross Section View

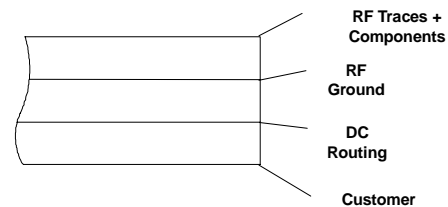

The IF output port is the open drain of the IF buffer amplifier. This allows maximum flexibility of intermediate frequency and also IF filter characteristics. A matching network such as that shown on page 2 can be used to match from the output impedance of the buffer to the input impedance of the filter at the required frequency. The inductor also acts as a choke for the DC supply line.

The LO input port is internally matched to 50 $\Omega$ . An LO buffer amplifier amplifies the -10 dBm input signal to the level required to drive the mixer. Performance is optimum with a drive level of -5 dBm

All DC supply lines must be properly bypassed at RF frequencies to obtain optimum performance and at lower frequency to maintain unconditional stability. Capacitors C1, C6, C11 and C14 are RF bypass capacitors for the LNA, RFA and LOA. The value and placement of these capacitors are critical in determining the frequency response of these amplifiers. Capacitor C10 is a source bypass capacitor for the second stage of the low noise amplifier. The placement of this capacitor will affect the gain of the LNA. For best performance, all the RF bypass capacitors should be placed as shown in the PCB drawing shown above. Capacitors C2, C5, C7, C12, C13 and C15 are 1000 pF low frequency DC supply bypass capacitors. Their value and placement are less critical than the other capacitors. However, for best results, these capacitors should be located as close to the package leads as possible.

Specifications subject to change without notice.

- North America: Tel. (800) 366-2266, Fax (800) 618-8883
- Asia/Pacific: Tel. +81-44-844-8296, Fax +81-44-844-8298
- Europe: Tel. +44 (1344) 869 595, Fax+44 (1344) 300 020

Visit [www.macom.com](http://www.macom.com) for additional data sheets and product information.

**Typical Performance Curves** LNA/Downconverter (with 3dB Pad in place of Image Reject Filter)

**Conversion Gain vs. Frequency**  
 $V_{DD} = 2.8V, 3.0V, 3.3V, LO = -10dBm$

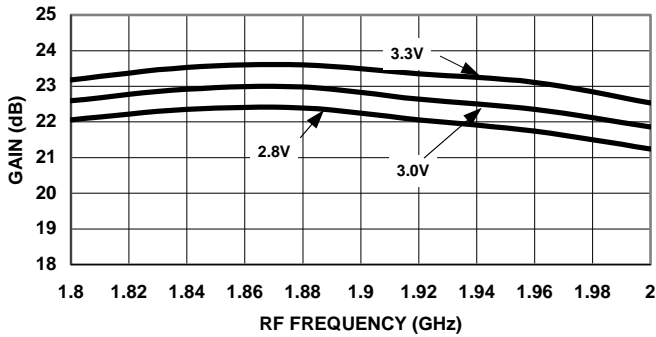

**Conversion Gain vs. Frequency**  
 $LO = -10 dBm, -5 dBm, V_{DD} = 3.0V$

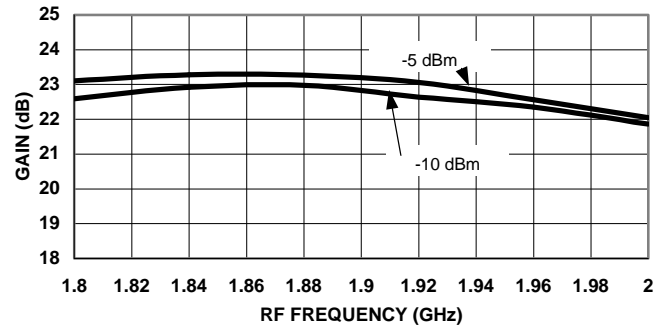

**Noise Figure vs. Frequency**  
 $V_{DD} = 2.8V, 3.0V, 3.3V, LO = -10dBm$

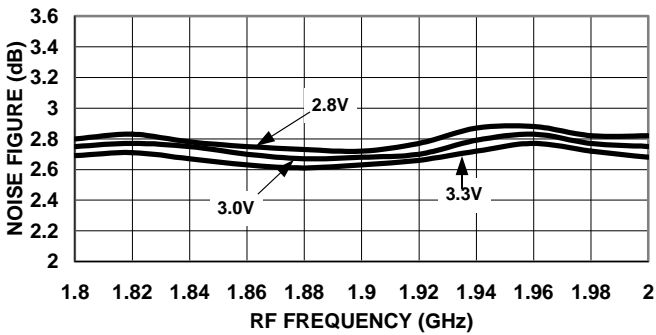

**Noise Figure vs. Frequency**  
 $LO = -10dBm, -5dBm, V_{DD} = 3.0V$

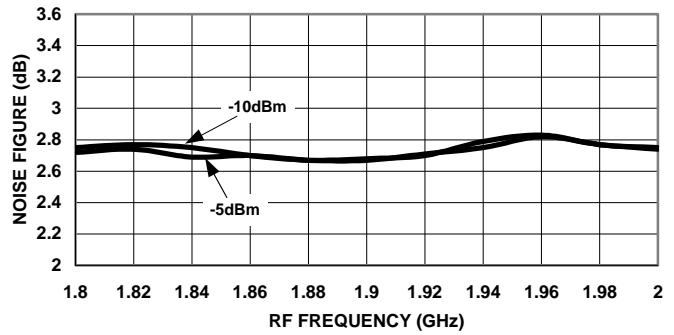

**Input IP<sub>3</sub> vs. Frequency**  
 $V_{DD} = 2.8V, 3.0V, 3.3V, LO = -10dBm$

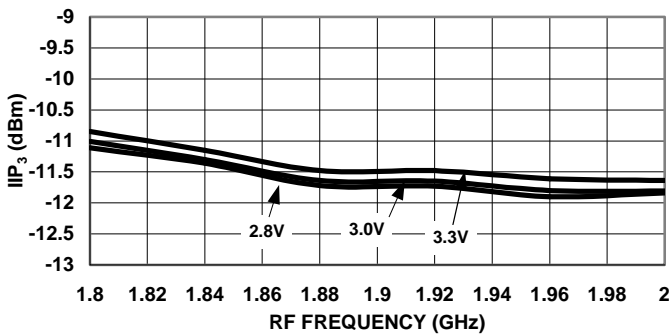

**Input IP<sub>3</sub> vs. Frequency**  
 $LO = -10dBm, -5dBm, V_{DD} = 3.0V$

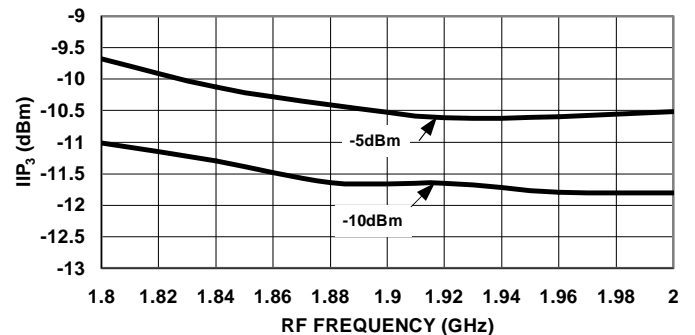

Specifications subject to change without notice.

V 2.0

- North America: Tel. (800) 366-2266, Fax (800) 618-8883
- Asia/Pacific: Tel.+81-44-844-8296, Fax +81-44-844-8298
- Europe: Tel. +44 (1344) 869 595, Fax+44 (1344) 300 020

Visit [www.macom.com](http://www.macom.com) for additional data sheets and product information.



**Typical Performance Curves LNA/Downconverter (with 3dB Pad in place of Image Reject Filter) Cont'd**

**LO Input Return Loss vs. Frequency**  
LO = -10dBm, V<sub>DD</sub> = 3.0V

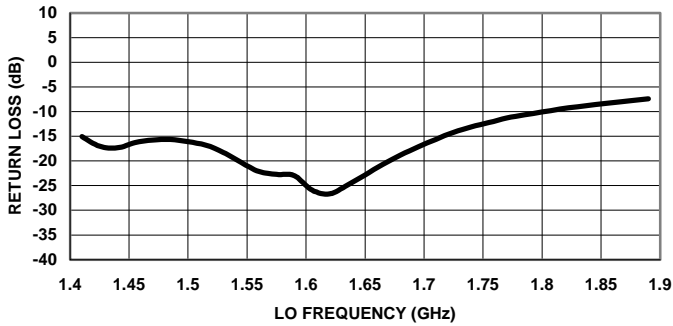

**IF Output Return Loss vs. Frequency**  
LO = -10dBm, V<sub>DD</sub> = 3.0V

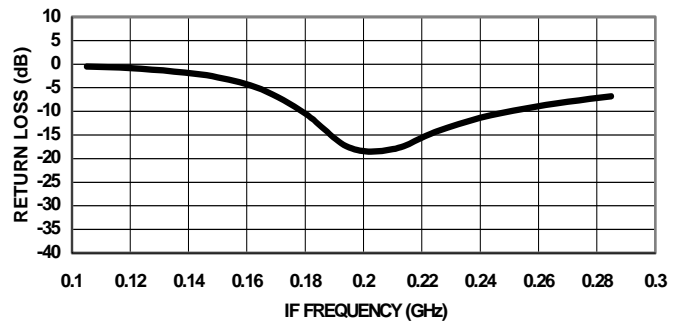

**Downconverter Input Return Loss vs. Frequency**  
LO = -10dBm, V<sub>DD</sub> = 3.0V

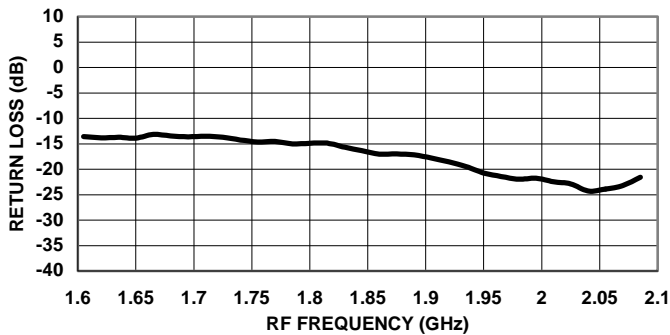

**LNA Gain, Noise Figure vs. Frequency**  
V<sub>DD</sub> = 3.0V

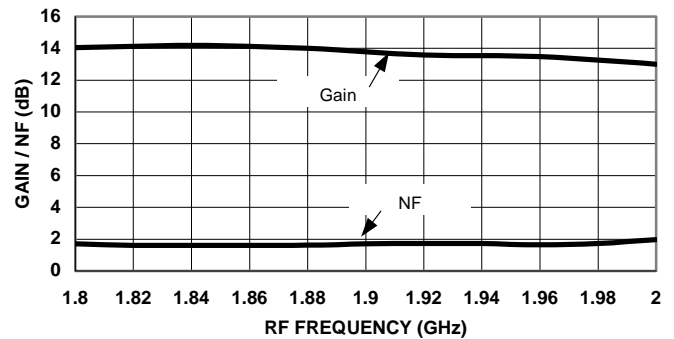

**LNA Input IP<sub>3</sub> vs. Frequency**  
V<sub>DD</sub> = 2.8V, 3.0V, 3.3V

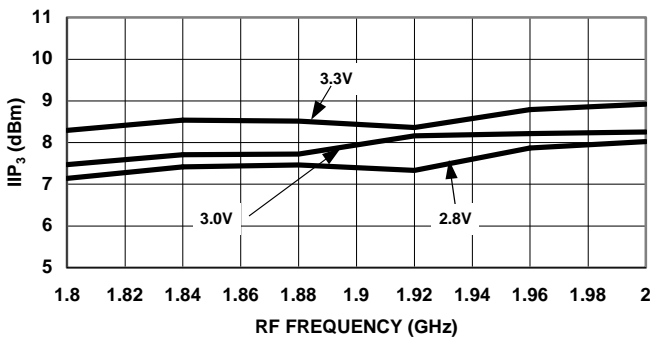

**LNA Input Return Loss vs. Frequency**  
V<sub>DD</sub> = 3.0V

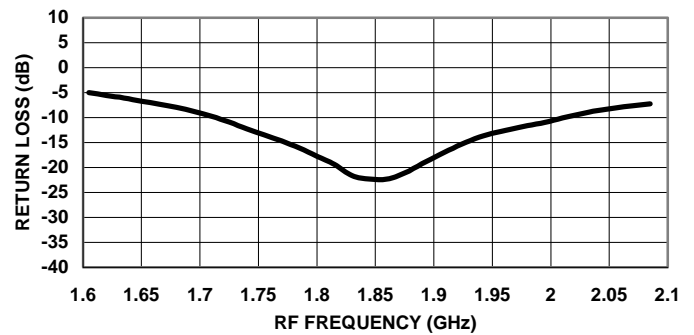

**LNA Output Return Loss vs. Frequency**  
V<sub>DD</sub> = 3.0V

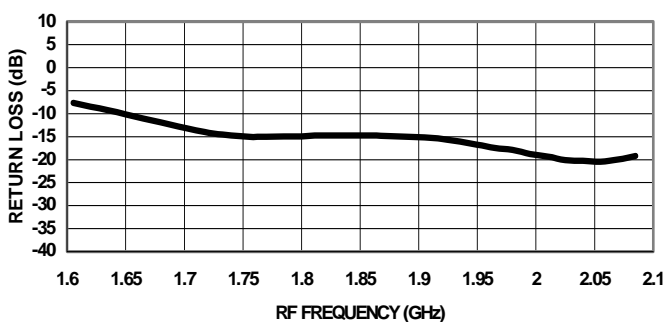

Specifications subject to change without notice.

V 2.0

- North America: Tel. (800) 366-2266, Fax (800) 618-8883
- Asia/Pacific: Tel. +81-44-844-8296, Fax +81-44-844-8298
- Europe: Tel. +44 (1344) 869 595, Fax +44 (1344) 300 020

Visit [www.macom.com](http://www.macom.com) for additional data sheets and product information.

