

PACKAGE DIMENSIONS

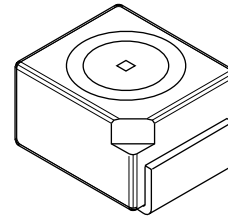
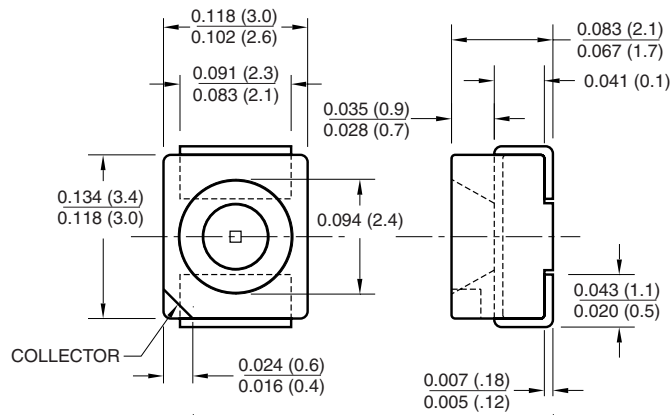

NOTES:

1. Dimensions for all drawings are in inches (millimeters).
2. Tolerance of $\pm .010$ (.25) on all non nominal dimensions unless otherwise specified.

FEATURES

- Surface Mount PLCC-2 Package
- Wide Reception Angle, 120°
- High Sensitivity
- Phototransistor Output
- Matched Emitter: QEB421
- Daylight Filter

SCHEMATIC

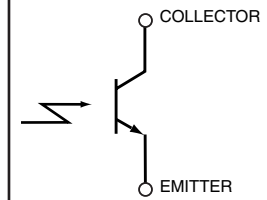

NOTES

1. Derate power dissipation linearly 2.2 mW/°C above 25°C.
2. RMA flux is recommended.
3. Methanol or isopropyl alcohols are recommended as cleaning agents.
4. $\lambda = 940$ nm.

ABSOLUTE MAXIMUM RATINGS (T_A = 25°C unless otherwise specified)

Parameter	Symbol	Rating	Unit
Operating Temperature	T _{OPR}	-55 to +100	°C
Storage Temperature	T _{STG}	-55 to +100	°C
Soldering Temperature (Flow) ^(2,3)	T _{SOL-F}	260 for 10 sec	°C
Collector Emitter Voltage	V _{CE}	35	V
Emitter Collector Voltage	V _{EC}	5	V
Collector Current	I _C	15	mA
Power Dissipation ⁽¹⁾	P _D	165	mW

ELECTRICAL / OPTICAL CHARACTERISTICS (T_A = 25°C)

PARAMETER	TEST CONDITIONS	SYMBOL	MIN	TYP	MAX	UNITS
Peak Sensitivity Wavelength		λ_{PS}	—	880	—	nm
Wavelength Sensitivity Range		λ_{SR}	700	—	1000	nm
Reception Angle		θ	—	120	—	Deg.
Collector Emitter Dark Current	V _{CE} = 25 V, E _e = 0	I _D	—	—	200	nA
Collector Emitter Breakdown	I _C = 1 mA	BV _{CEO}	30	—	—	V
Emitter Collector Breakdown	I _E = 100 μ A	BV _{ECO}	5	—	—	V
On-State Collector Current	E _e = 0.1 mW/cm ² (4), V _{CE} = 5 V	I _{C(ON)}	16	—	—	μ A
Saturation Voltage	E _e = 0.5 mW/cm ² (4), I _C = 0.05 mA	V _{CE(SAT)}	—	—	0.3	V
Rise Time	V _{CC} = 5 V, R _L = 100 Ω	t _r	—	8	—	μ s
Fall Time	I _C = 1 mA	t _f	—	8	—	μ s

Fig.1 Dark Current Vs. Ambient Temperature

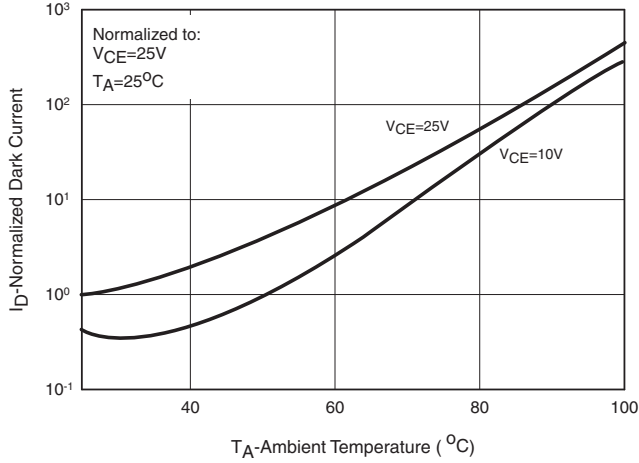

Fig.2 Dark Current Vs. Collector Emitter Voltage

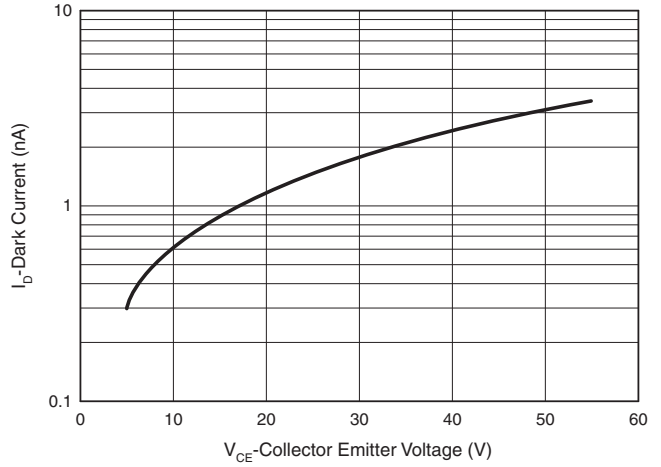

Fig.3 Light Current Vs. Collector to Emitter Voltage

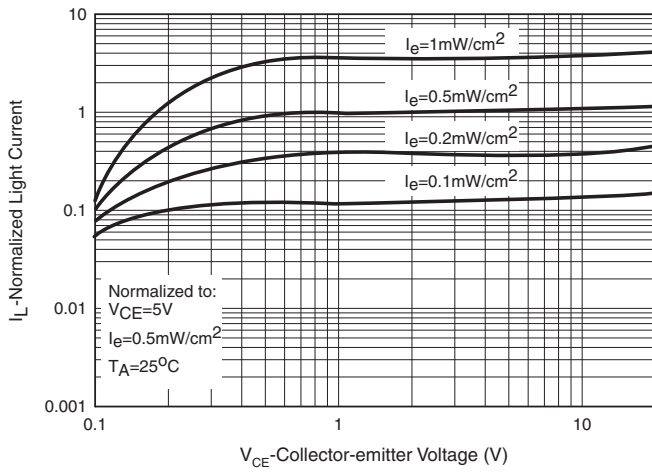
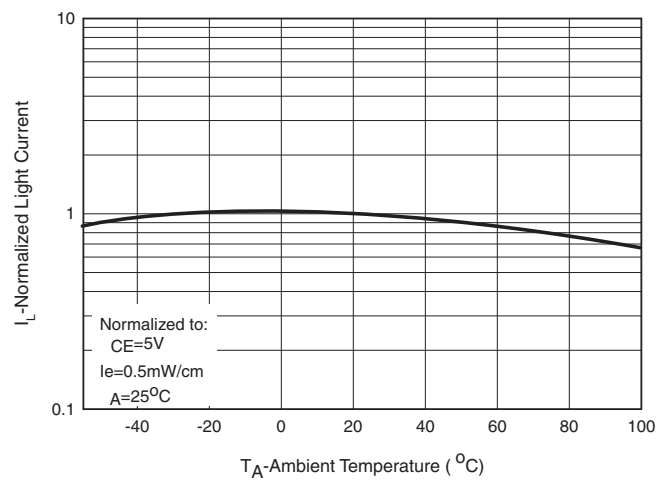

Fig4. Light Current Vs. Ambient Temperature



DISCLAIMER

FAIRCHILD SEMICONDUCTOR RESERVES THE RIGHT TO MAKE CHANGES WITHOUT FURTHER NOTICE TO ANY PRODUCTS HEREIN TO IMPROVE RELIABILITY, FUNCTION OR DESIGN. FAIRCHILD DOES NOT ASSUME ANY LIABILITY ARISING OUT OF THE APPLICATION OR USE OF ANY PRODUCT OR CIRCUIT DESCRIBED HEREIN; NEITHER DOES IT CONVEY ANY LICENSE UNDER ITS PATENT RIGHTS, NOR THE RIGHTS OF OTHERS.

LIFE SUPPORT POLICY

FAIRCHILD'S PRODUCTS ARE NOT AUTHORIZED FOR USE AS CRITICAL COMPONENTS IN LIFE SUPPORT DEVICES OR SYSTEMS WITHOUT THE EXPRESS WRITTEN APPROVAL OF THE PRESIDENT OF FAIRCHILD SEMICONDUCTOR CORPORATION. As used herein:

1. Life support devices or systems are devices or systems which, (a) are intended for surgical implant into the body, or (b) support or sustain life, and (c) whose failure to perform when properly used in accordance with instructions for use provided in labeling, can be reasonably expected to result in a significant injury of the user.
2. A critical component in any component of a life support device or system whose failure to perform can be reasonably expected to cause the failure of the life support device or system, or to affect its safety or effectiveness.