

15A, 400V - 600V Ultrafast Dual Diodes

The RURG1540CC and RURG1560CC are ultrafast dual diodes with soft recovery characteristics ($t_{rr} < 55\text{ns}$). They have low forward voltage drop and are of silicon nitride passivated ion-implanted epitaxial planar construction.

These devices are intended for use as freewheeling/clamping diodes and rectifiers in a variety of switching power supplies and other power switching applications. Their low stored charge and ultrafast recovery with soft recovery characteristics minimize ringing and electrical noise in many power switching circuits reducing power loss in the switching transistors.

Formerly developmental type TA09905.

Ordering Information

PART NUMBER	PACKAGE	BRAND
RURG1540CC	TO-247	RURG1540C
RURG1560CC	TO-247	RURG1560C

NOTE: When ordering, use the entire part number.

Symbol

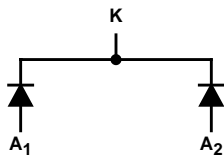

Features

- Ultrafast with Soft Recovery <55ns
- Operating Temperature 175°C
- Reverse Voltage Up to 600V
- Avalanche Energy Rated
- Planar Construction

Applications

- Switching Power Supplies
- Power Switching Circuits
- General Purpose

Packaging

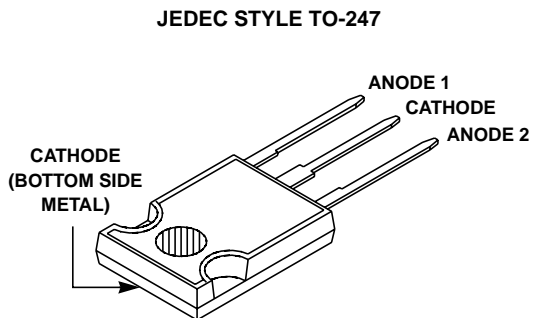

Absolute Maximum Ratings (Per Leg) $T_C = 25^\circ\text{C}$

	RURG1540CC	RURG1560CC	UNITS
Peak Repetitive Reverse Voltage V_{RRM}	400	600	V
Working Peak Reverse Voltage V_{RWM}	400	600	V
DC Blocking Voltage V_R	400	600	V
Average Rectified Forward Current $I_F(AV)$ ($T_C = 145^\circ\text{C}$)	15	15	A
Repetitive Peak Surge Current I_{FRM} (Square Wave, 20kHz)	30	30	A
Nonrepetitive Peak Surge Current I_{FSM} (Halfwave, 1 Phase, 60Hz)	200	200	A
Maximum Power Dissipation P_D	100	100	W
Avalanche Energy (See Figures 7 and 8) E_{AVL}	20	20	mJ
Operating and Storage Temperature T_{STG}, T_J	-65 to 175	-65 to 175	°C

RURG1540CC, RURG1560CC

Electrical Specifications (Per Leg) $T_C = 25^\circ\text{C}$, Unless Otherwise Specified

SYMBOL	TEST CONDITION	RURG1540CC			RURG1560CC			UNITS
		MIN	TYP	MAX	MIN	TYP	MAX	
V_F	$I_F = 15\text{A}$	-	-	1.5	-	-	1.5	V
	$I_F = 15\text{A}, T_C = 150^\circ\text{C}$	-	-	1.3	-	-	1.3	V
I_R	$V_R = 400\text{V}$	-	-	100	-	-	-	μA
	$V_R = 600\text{V}$	-	-	-	-	-	100	μA
	$V_R = 400\text{V}, T_C = 150^\circ\text{C}$	-	-	500	-	-	-	μA
	$V_R = 600\text{V}, T_C = 150^\circ\text{C}$	-	-	-	-	-	500	μA
t_{rr}	$I_F = 1\text{A}, dI_F/dt = 100\text{A}/\mu\text{s}$	-	-	55	-	-	55	ns
	$I_F = 15\text{A}, dI_F/dt = 100\text{A}/\mu\text{s}$	-	-	60	-	-	60	ns
t_a	$I_F = 15\text{A}, dI_F/dt = 100\text{A}/\mu\text{s}$	-	30	-	-	30	-	ns
t_b	$I_F = 15\text{A}, dI_F/dt = 100\text{A}/\mu\text{s}$	-	17	-	-	17	-	ns
$R_{\theta JC}$		-	-	1.5	-	-	1.5	$^\circ\text{C}/\text{W}$

DEFINITIONS

V_F = Instantaneous forward voltage ($p_w = 300\mu\text{s}$, $D = 2\%$).

I_R = Instantaneous reverse current.

t_{rr} = Reverse recovery time (See Figure 6), summation of $t_a + t_b$.

t_a = Time to reach peak reverse current (See Figure 6).

t_b = Time from peak I_{RM} to projected zero crossing of I_{RM} based on a straight line from peak I_{RM} through 25% of I_{RM} (See Figure 6).

$R_{\theta JC}$ = Thermal resistance junction to case.

p_w = Pulse width.

D = Duty cycle.

Typical Performance Curves

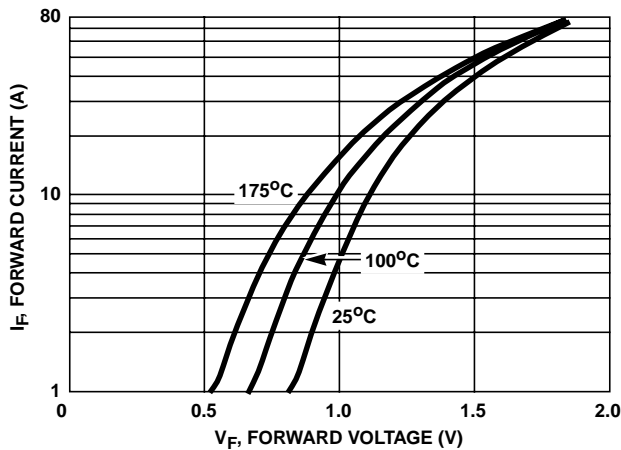

FIGURE 1. FORWARD CURRENT vs FORWARD VOLTAGE

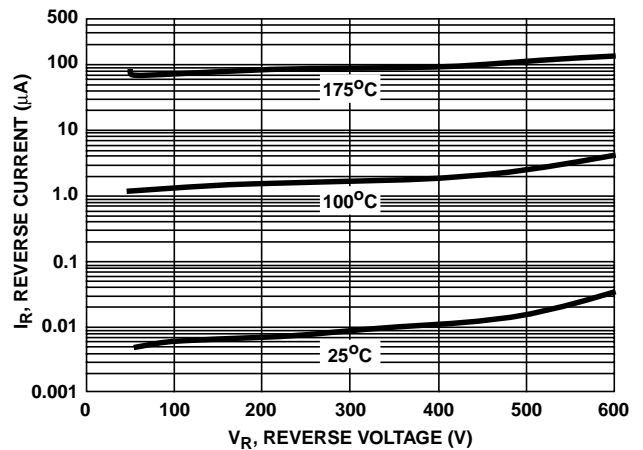

FIGURE 2. REVERSE CURRENT vs REVERSE VOLTAGE

Typical Performance Curves (Continued)

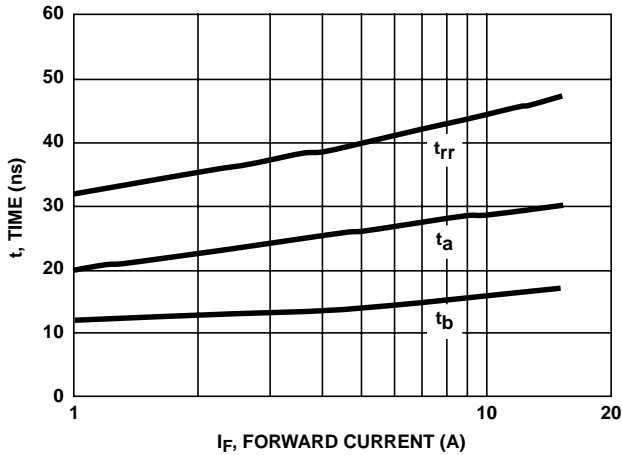

FIGURE 3. t_{rr} , t_a AND t_b CURVES vs FORWARD CURRENT

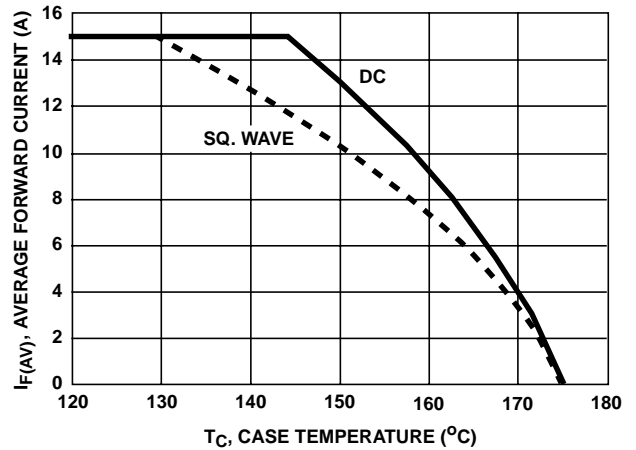

FIGURE 4. CURRENT DERATING CURVE

Test Circuits and Waveforms

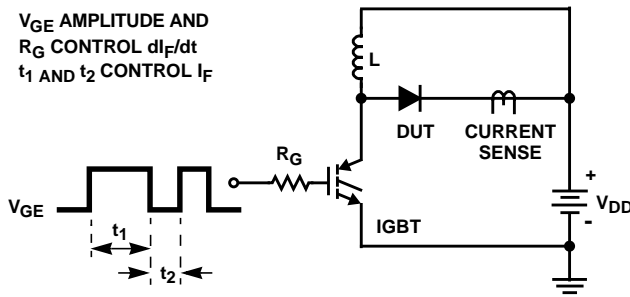

FIGURE 5. t_{rr} TEST CIRCUIT

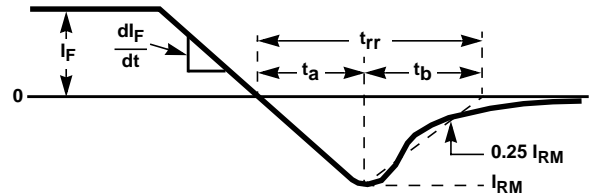

FIGURE 6. t_{rr} WAVEFORMS AND DEFINITIONS

$I = 1A$
 $L = 40mH$
 $R < 0.1\Omega$
 $E_{AVL} = 1/2LI^2 [V_{R(AVL)}/(V_{R(AVL)} - V_{DD})]$
 $Q_1 = IGBT (BV_{CES} > DUT V_{R(AVL)})$

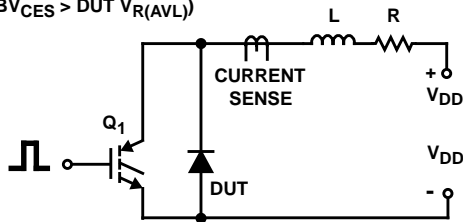

FIGURE 7. AVALANCHE ENERGY TEST CIRCUIT

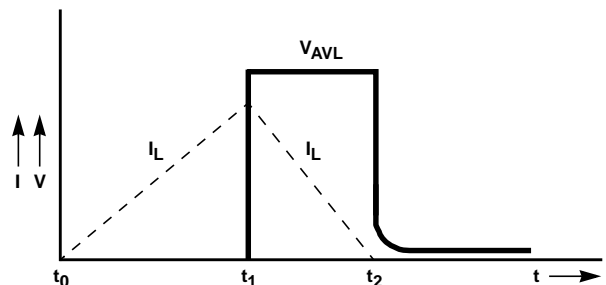

FIGURE 8. AVALANCHE CURRENT AND VOLTAGE WAVEFORMS

All Intersil semiconductor products are manufactured, assembled and tested under ISO9000 quality systems certification.

Intersil semiconductor products are sold by description only. Intersil Corporation reserves the right to make changes in circuit design and/or specifications at any time without notice. Accordingly, the reader is cautioned to verify that data sheets are current before placing orders. Information furnished by Intersil is believed to be accurate and reliable. However, no responsibility is assumed by Intersil or its subsidiaries for its use; nor for any infringements of patents or other rights of third parties which may result from its use. No license is granted by implication or otherwise under any patent or patent rights of Intersil or its subsidiaries.

For information regarding Intersil Corporation and its products, see web site www.intersil.com