

FEATURES

Excellent Video Performance

Differential Gain & Phase Error of 0.01% & 0.05°

High Speed

130 MHz 3 dB Bandwidth ($G = +2$)

450 V/ μ s Slew Rate

80 ns Settling Time to 0.01%

Low Power

15 mA Max Power Supply Current

High Output Drive Capability:

50 mA Minimum Output Current per Amplifier

Ideal for Driving Back Terminated Cables

Flexible Power Supply

Specified for +5 V, ± 5 V and ± 15 V Operation

± 3.2 V Min Output Swing into a 150 Ω Load
($V_S = \pm 5$ V)

Excellent DC Performance

2.0 mV Input Offset Voltage

Available in 8-Lead SOIC and 8-Lead Plastic Mini-DIP

FUNCTIONAL BLOCK DIAGRAM

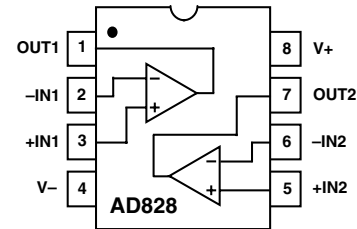

PRODUCT DESCRIPTION

The AD828 is a low cost, dual video op amp optimized for use in video applications which require gains of +2 or greater and high output drive capability, such as cable driving. Due to its low power and single supply functionality, along with excellent differential gain and phase errors, the AD828 is ideal for power sensitive applications such as video cameras and professional video equipment.

With video specs like 0.1 dB flatness to 40 MHz and low differential gain and phase errors of 0.01% and 0.05°, along with 50 mA of output current per amplifier, the AD828 is an excellent choice for any video application. The 130 MHz gain bandwidth and 450 V/ μ s slew rate make the AD828 useful in many high speed applications including: video monitors, CATV, color copiers, image scanners and fax machines.

The AD828 is fully specified for operation with a single +5 V power supply and with dual supplies from ± 5 V to ± 15 V. This power supply flexibility, coupled with a very low supply current of 15 mA and excellent ac characteristics under all power supply conditions, make the AD828 the ideal choice for many demanding yet power sensitive applications.

The AD828 is a voltage feedback op amp which excels as a gain stage (gains $>+2$) or active filter in high speed and video systems and achieves a settling time of 45 ns to 0.1%, with a low input offset voltage of 2 mV max.

The AD828 is available in low cost, small 8-lead plastic mini-DIP and SOIC packages.

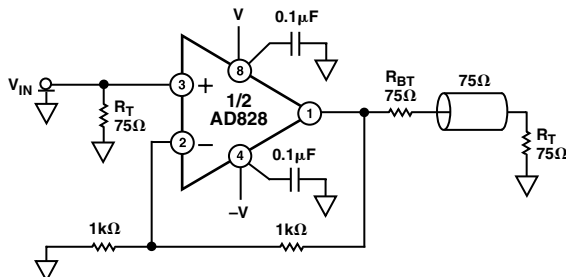

Figure 1. Video Line Driver

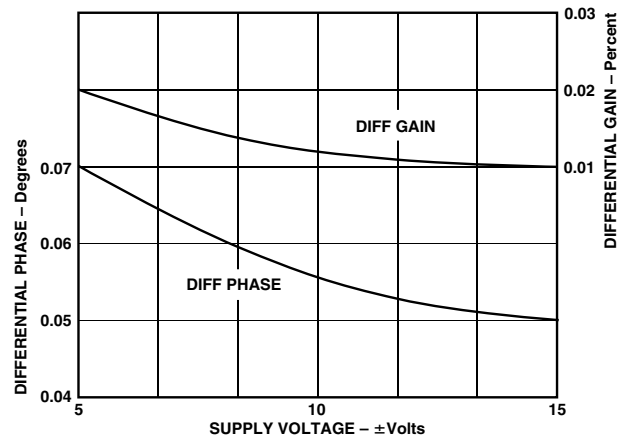

Figure 2. Differential Phase vs. Supply Voltage

REV. B

Information furnished by Analog Devices is believed to be accurate and reliable. However, no responsibility is assumed by Analog Devices for its use, nor for any infringements of patents or other rights of third parties which may result from its use. No license is granted by implication or otherwise under any patent or patent rights of Analog Devices.

AD828—SPECIFICATIONS (@ T_A = +25°C, unless otherwise noted)

Parameter	Conditions	V _S	AD828			Unit
			Min	Typ	Max	
DYNAMIC PERFORMANCE						
-3 dB Bandwidth	Gain = +2	±5 V	60	85		MHz
		±15 V	100	130		MHz
Bandwidth for 0.1 dB Flatness	Gain = -1	0, +5 V	30	45		MHz
		±5 V	35	55		MHz
		±15 V	60	90		MHz
	Gain = +2 C _C = 1 pF	0, +5 V	20	35		MHz
		±5 V	30	43		MHz
		±15 V	30	40		MHz
Full Power Bandwidth ¹	Gain = -1 C _C = 1 pF	0, +5 V	10	18		MHz
		±5 V	15	25		MHz
		±15 V	30	50		MHz
	V _{OUT} = 5 V p-p R _{LOAD} = 500 Ω	0, +5 V	10	19		MHz
		±5 V		22.3		MHz
		V _{OUT} = 20 V p-p R _{LOAD} = 1 kΩ			7.2	MHz
Slew Rate	R _{LOAD} 1 kΩ Gain = -1	±15 V	300	350		V/μs
		±5 V	400	450		V/μs
		±15 V	200	250		V/μs
Settling Time to 0.1% to 0.01%	-2.5 V to +2.5 V 0 V-10 V Step, A _V = -1	0, +5 V	200	250		V/μs
		±5 V		45		ns
		±15 V		45		ns
		±5 V		80		ns
	0 V-10 V Step, A _V = -1	±15 V		80		ns
NOISE/HARMONIC PERFORMANCE						
Total Harmonic Distortion	F _C = 1 MHz	±15 V		-78		dB
Input Voltage Noise	f = 10 kHz	±5 V, ±15 V		10		nV/√Hz
Input Current Noise	f = 10 kHz	±5 V, ±15 V		1.5		pA/√Hz
Differential Gain Error (R _L = 150 Ω)	NTSC Gain = +2	±15 V		0.01	0.02	%
		±5 V		0.02	0.03	%
Differential Phase Error (R _L = 150 Ω)	NTSC Gain = +2	0, +5 V		0.08		%
		±15 V		0.05	0.09	Degrees
		±5 V		0.07	0.1	Degrees
		0, +5 V		0.1		Degrees
DC PERFORMANCE						
Input Offset Voltage	T _{MIN} to T _{MAX}	±5 V, ±15 V		0.5	2	mV
					3	mV
Offset Drift				10		μV/°C
Input Bias Current	T _{MIN} T _{MAX}	±5 V, ±15 V		3.3	6.6	μA
					10	μA
					4.4	μA
Input Offset Current	T _{MIN} to T _{MAX}	±5 V, ±15 V		25	300	nA
					500	nA
Offset Current Drift				0.3		nA/°C
Open Loop Gain	V _{OUT} = ±2.5 V R _{LOAD} = 500 Ω	±5 V	3	5		V/mV
		T _{MIN} to T _{MAX}	2			V/mV
		R _{LOAD} = 150 Ω	2	4		V/mV
	V _{OUT} = ±10 V R _{LOAD} = 1 kΩ	±15 V	5.5	9		V/mV
		T _{MIN} to T _{MAX}	2.5			V/mV
		V _{OUT} = ±7.5 V R _{LOAD} = 150 Ω (50 mA Output)	3	5		V/mV
INPUT CHARACTERISTICS						
Input Resistance				300		kΩ
Input Capacitance				1.5		pF
Input Common-Mode Voltage Range		±5 V	+3.8	+4.3		V
			-2.7	-3.4		V
		±15 V	+13	+14.3		V
			-12	-13.4		V
		0, +5 V	+3.8	+4.3		V
			+1.2	+0.9		V
Common-Mode Rejection Ratio	V _{CM} = +2.5 V, T _{MIN} to T _{MAX}	±5 V	82	100		dB
		±15 V	86	120		dB
		±15 V	84	100		dB

Parameter	Conditions	V _s	Min	Typ	Max	Unit
OUTPUT CHARACTERISTICS						
Output Voltage Swing	R _{LOAD} = 500 Ω	±5 V	3.3	3.8		±V
	R _{LOAD} = 150 Ω	±5 V	3.2	3.6		±V
	R _{LOAD} = 1 kΩ	±15 V	13.3	13.7		±V
	R _{LOAD} = 500 Ω	±15 V	12.8	13.4		±V
Output Current	R _{LOAD} = 500 Ω	0, +5 V	+1.5,			±V
		±15 V	+3.5			mA
		±5 V	50			mA
		±5 V	40			mA
Short-Circuit Current		0, +5 V	30			mA
Output Resistance	Open Loop	±15 V		90		mA
				8		Ω
MATCHING CHARACTERISTICS						
Dynamic						
Crosstalk	f = 5 MHz	±15 V		-80		dB
Gain Flatness Match	G = +1, f = 40 MHz	±15 V		0.2		dB
Skew Rate Match	G = -1	±15 V		10		V/μs
DC						
Input Offset Voltage Match	T _{MIN} to T _{MAX}	±5 V, ±15 V		0.5	2	mV
Input Bias Current Match	T _{MIN} to T _{MAX}	±5 V, ±15 V		0.06	0.8	μA
Open-Loop Gain Match	V _O = ±10 V, R _L = 1 kΩ, T _{MIN} to T _{MAX}	±15 V		0.01	0.15	mV/V
Common-Mode Rejection Ratio Match	V _{CM} = ±12 V, T _{MIN} to T _{MAX}	±15 V	80	100		dB
Power Supply Rejection Ratio Match	±5 V to ±15 V, T _{MIN} to T _{MAX}		80	100		dB
POWER SUPPLY						
Operating Range	Dual Supply		±2.5		±18	V
	Single Supply		+5		+36	V
Quiescent Current		±5 V		14.0	15	mA
	T _{MIN} to T _{MAX}	±5 V		14.0	15	mA
	T _{MIN} to T _{MAX}	±5 V			15	mA
Power Supply Rejection Ratio	V _S = ±5 V to ±15 V, T _{MIN} to T _{MAX}		80	90		dB

NOTES

¹Full power bandwidth = slew rate/2 π V_{PEAK}.
 Specifications subject to change without notice.

ABSOLUTE MAXIMUM RATINGS¹

Supply Voltage	±18 V
Internal Power Dissipation ²	
Plastic DIP (N)	See Derating Curves
Small Outline (R)	See Derating Curves
Input Voltage (Common Mode)	±V _S
Differential Input Voltage	±6 V
Output Short Circuit Duration	See Derating Curves
Storage Temperature Range (N, R)	-65°C to +125°C
Operating Temperature Range	-40°C to +85°C
Lead Temperature Range (Soldering 10 sec)	+300°C

NOTES

¹Stresses above those listed under Absolute Maximum Ratings may cause permanent damage to the device. This is a stress rating only; functional operation of the device at these or any other conditions above those indicated in the operational section of this specification is not implied. Exposure to absolute maximum rating conditions for extended periods may affect device reliability.

²Specification is for device in free air:
 8-Lead Plastic DIP Package: θ_{JA} = 100°C/Watt
 8-Lead SOIC Package: θ_{JA} = 155°C/Watt

CAUTION

ESD (electrostatic discharge) sensitive device. Electrostatic charges as high as 4000 V readily accumulate on the human body and test equipment and can discharge without detection. Although the AD828 features proprietary ESD protection circuitry, permanent damage may occur on devices subjected to high-energy electrostatic discharges. Therefore, proper ESD precautions are recommended to avoid performance degradation or loss of functionality.

ORDERING GUIDE

Model	Temperature Range	Package Description	Package Option
AD828AN	-40°C to +85°C	8-Lead Plastic DIP	N-8
AD828AR	-40°C to +85°C	8-Lead Plastic SOIC	SO-8
AD828AR-REEL7	-40°C to +85°C	7" Tape & Reel	SO-8
AD828AR-REEL	-40°C to +85°C	13" Tape & Reel	SO-8

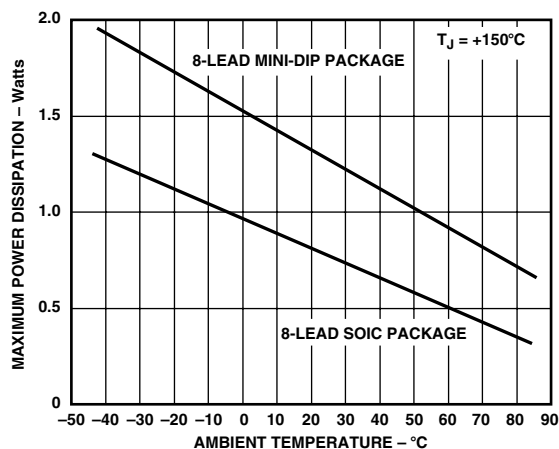

Figure 3. Maximum Power Dissipation vs. Temperature for Different Package Types



AD828—Typical Characteristics

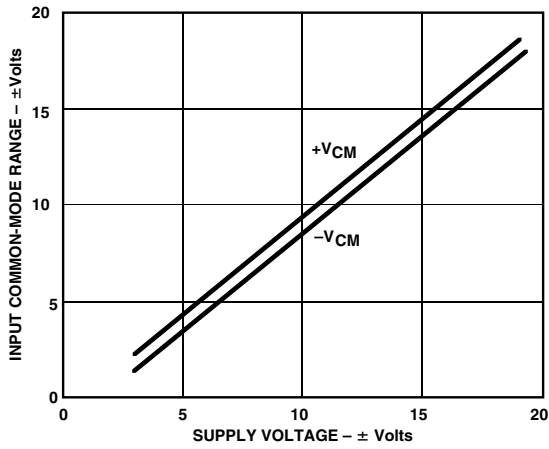

Figure 4. Common-Mode Voltage Range vs. Supply Voltage

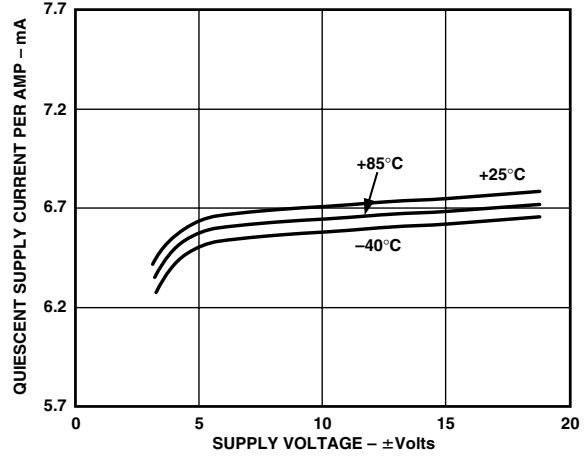

Figure 7. Quiescent Supply Current per Amp vs. Supply Voltage for Various Temperatures

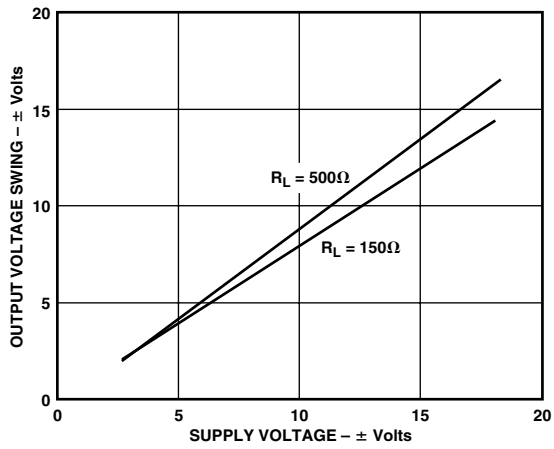

Figure 5. Output Voltage Swing vs. Supply Voltage

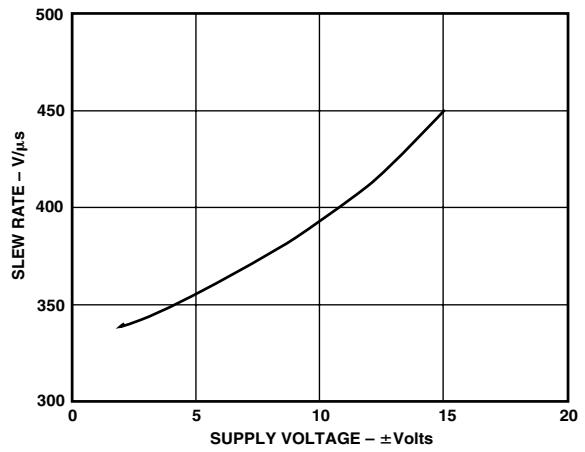

Figure 8. Slew Rate vs. Supply Voltage

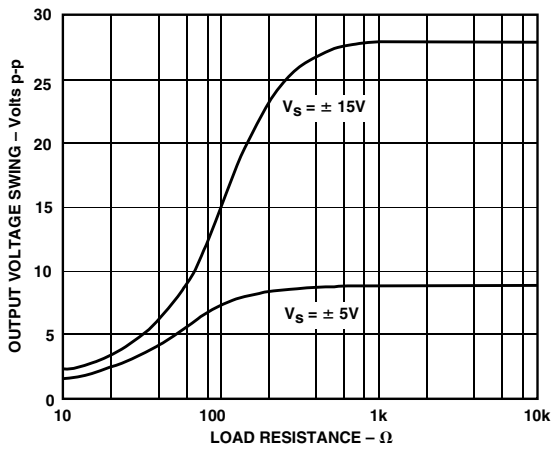

Figure 6. Output Voltage Swing vs. Load Resistance

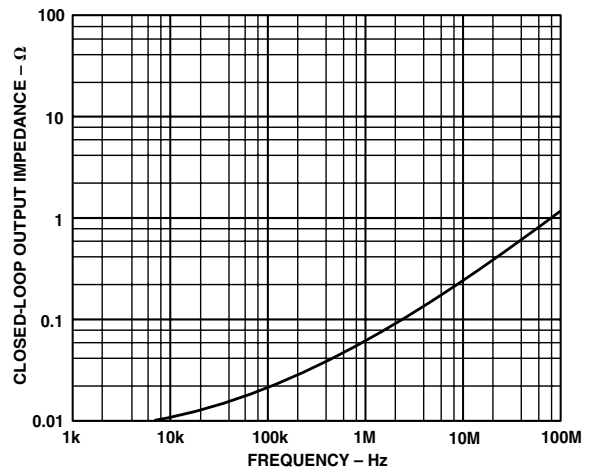

Figure 9. Closed-Loop Output Impedance vs. Frequency

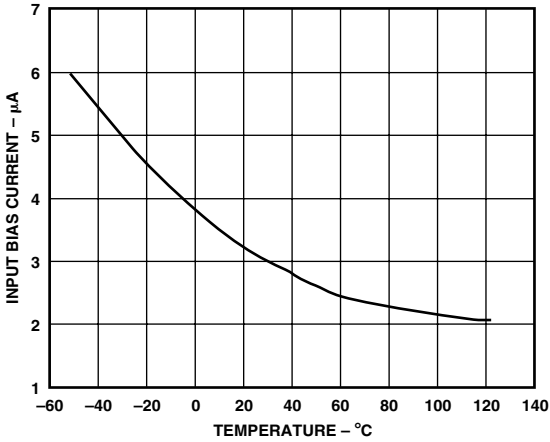

Figure 10. Input Bias Current vs. Temperature

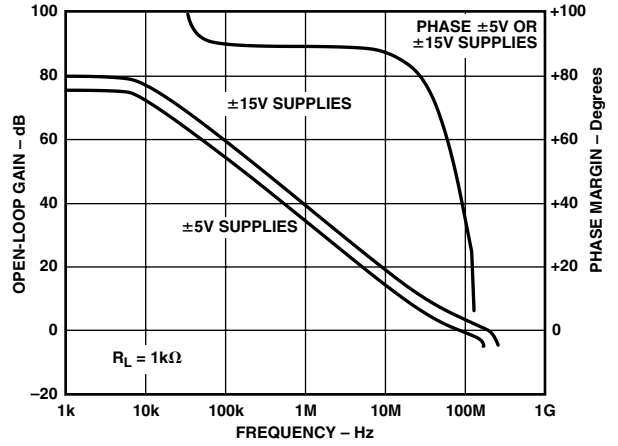

Figure 13. Open-Loop Gain and Phase Margin vs. Frequency

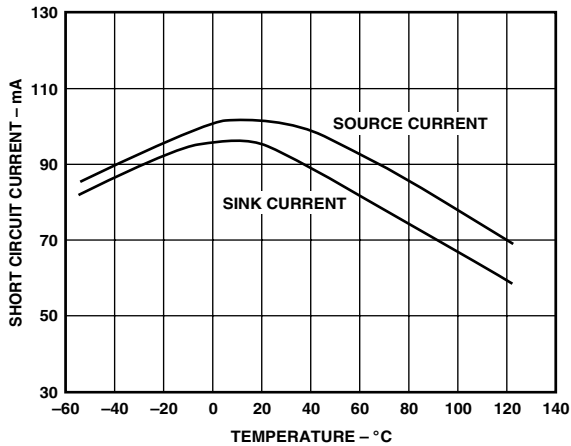

Figure 11. Short Circuit Current vs. Temperature

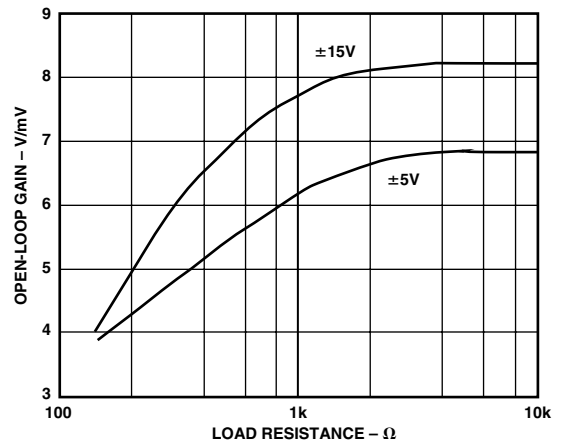

Figure 14. Open-Loop Gain vs. Load Resistance

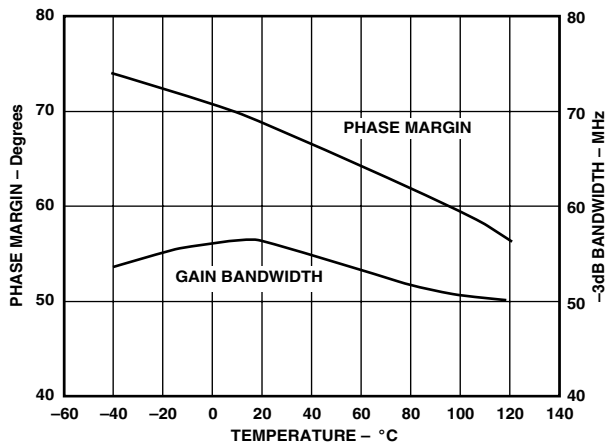

Figure 12. -3 dB Bandwidth and Phase Margin vs. Temperature, Gain = +2

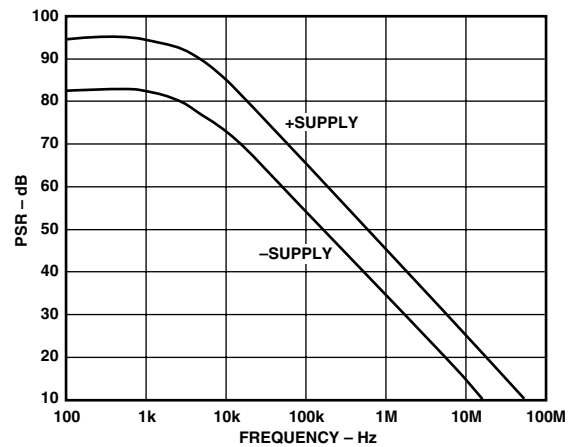

Figure 15. Power Supply Rejection vs. Frequency

AD828—Typical Characteristics

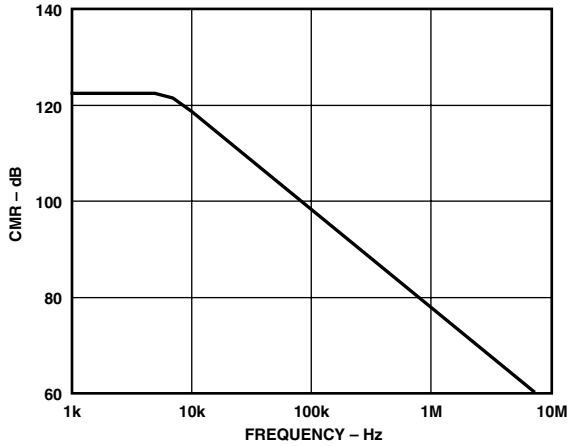

Figure 16. Common-Mode Rejection vs. Frequency

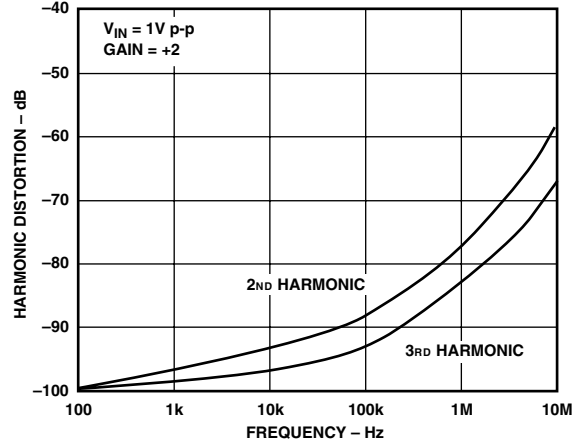

Figure 19. Harmonic Distortion vs. Frequency

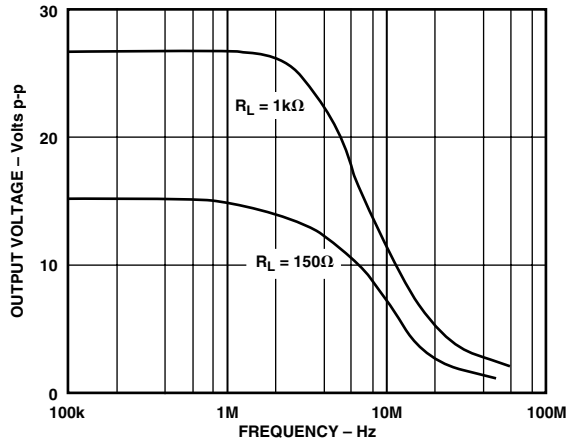

Figure 17. Large Signal Frequency Response

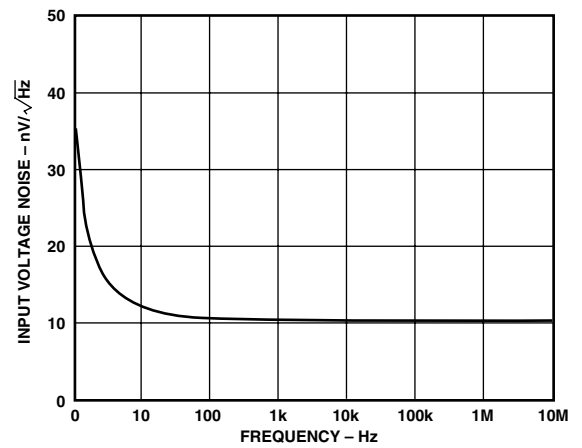

Figure 20. Input Voltage Noise Spectral Density vs. Frequency

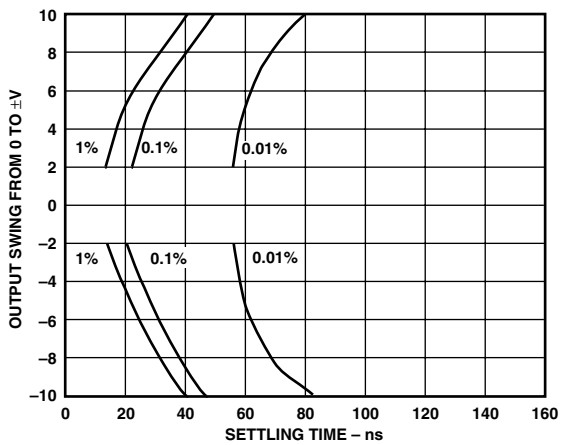

Figure 18. Output Swing and Error vs. Settling Time

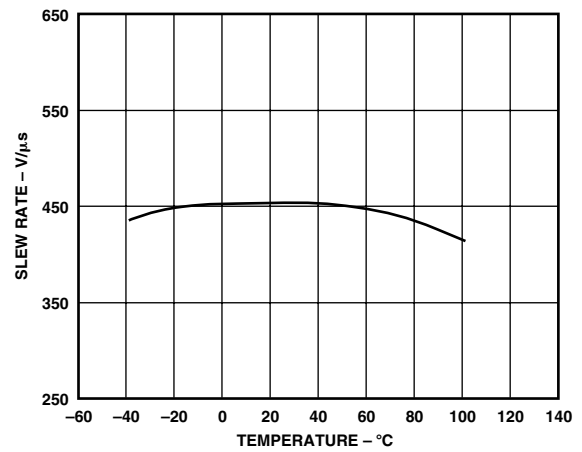

Figure 21. Slew Rate vs. Temperature

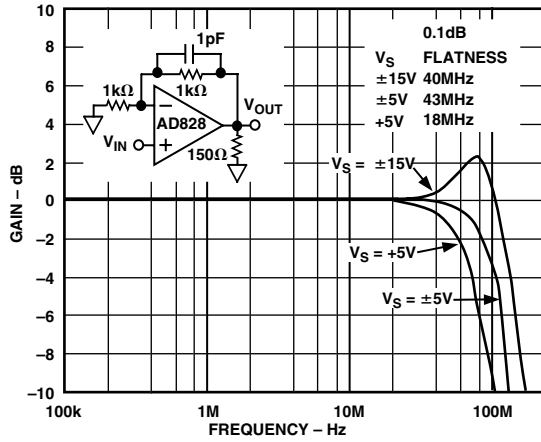

Figure 22. Closed-Loop Gain vs. Frequency

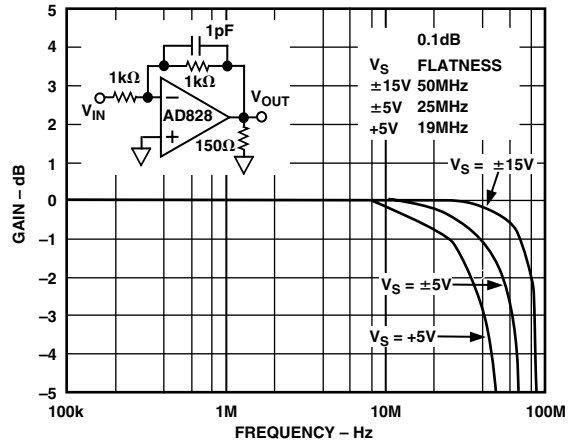

Figure 25. Closed-Loop Gain vs. Frequency, $G = -1$

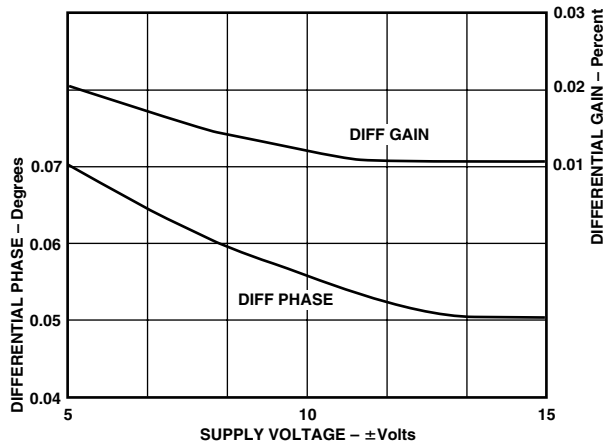

Figure 23. Differential Gain and Phase vs. Supply Voltage

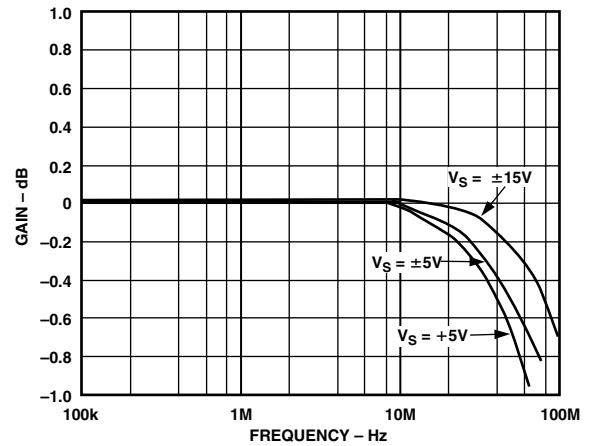

Figure 26. Gain Flatness Matching vs. Supply, $G = +2$

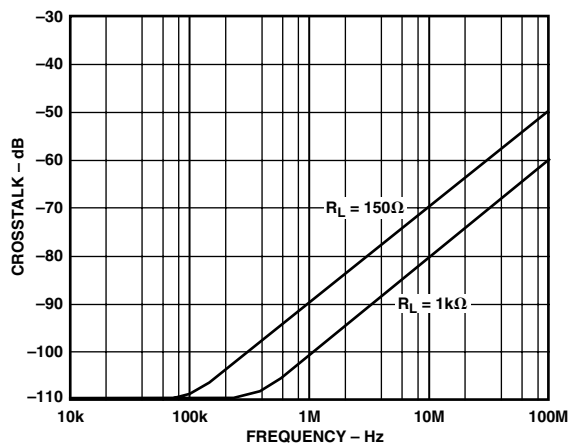

Figure 24. Crosstalk vs. Frequency

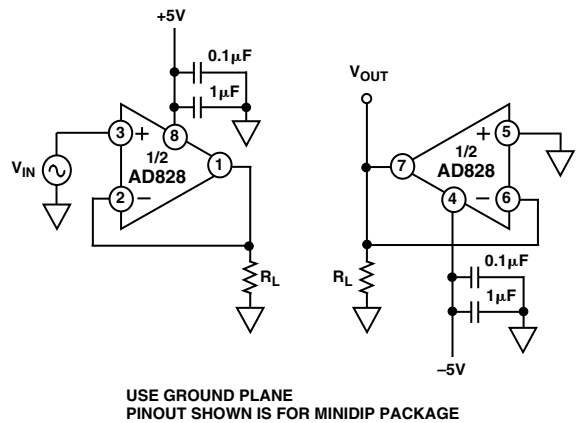

Figure 27. Crosstalk Test Circuit

AD828—Typical Characteristics

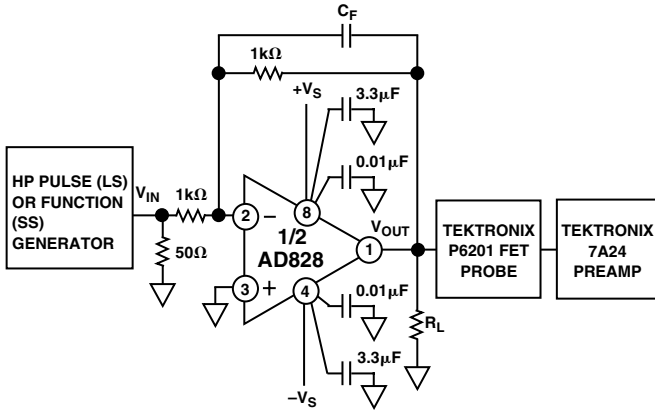

Figure 28. Inverting Amplifier Connection

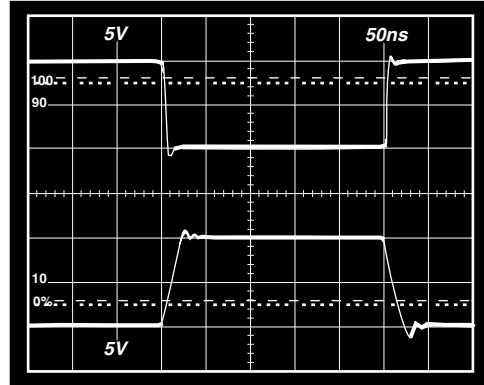

Figure 31. Inverter Large Signal Pulse Response $\pm 15 V_S$, $C_F = 1 \text{ pF}$, $R_L = 1 \text{ k}\Omega$

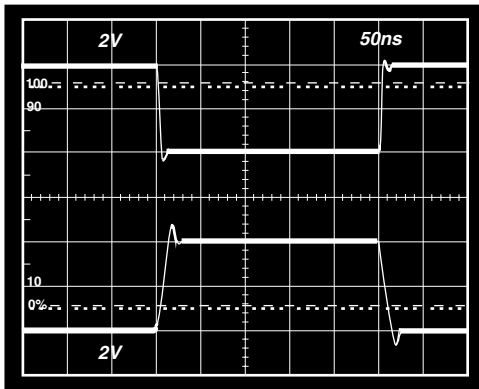

Figure 29. Inverter Large Signal Pulse Response $\pm 5 V_S$, $C_F = 1 \text{ pF}$, $R_L = 1 \text{ k}\Omega$

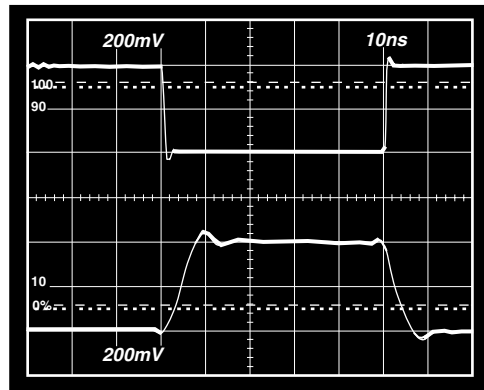

Figure 32. Inverter Small Signal Pulse Response $\pm 15 V_S$, $C_F = 1 \text{ pF}$, $R_L = 1500 \Omega$

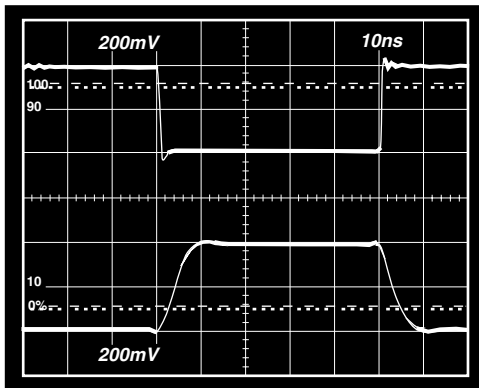

Figure 30. Inverter Small Signal Pulse Response $\pm 5 V_S$, $C_F = 1 \text{ pF}$, $R_L = 150 \Omega$

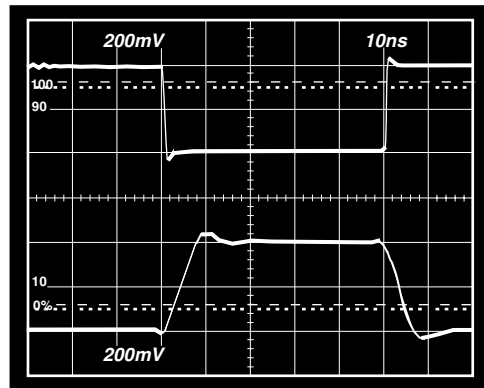

Figure 33. Inverter Small Signal Pulse Response $\pm 5 V_S$, $C_F = 0 \text{ pF}$, $R_L = 150 \Omega$

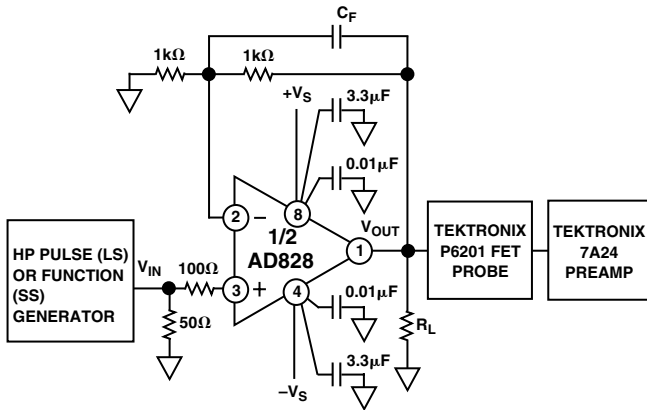

Figure 34. Noninverting Amplifier Connection

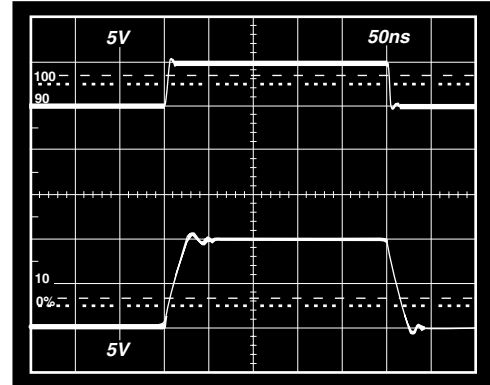

Figure 37. Noninverting Large Signal Pulse Response $\pm 15 V_S$, $C_F = 1 pF$, $R_L = 1 k\Omega$

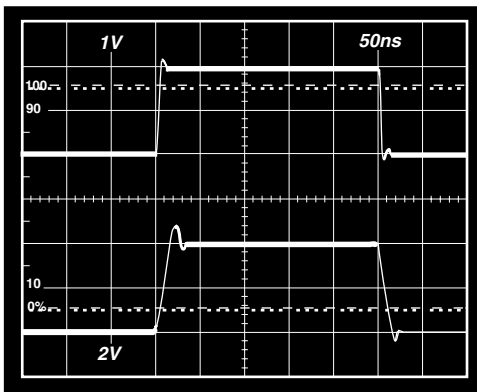

Figure 35. Noninverting Large Signal Pulse Response $\pm 5 V_S$, $C_F = 1 pF$, $R_L = 1 k\Omega$

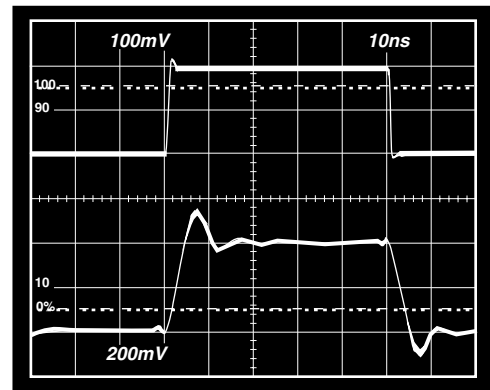

Figure 38. Noninverting Small Signal Pulse Response $\pm 15 V_S$, $C_F = 1 pF$, $R_L = 150 \Omega$

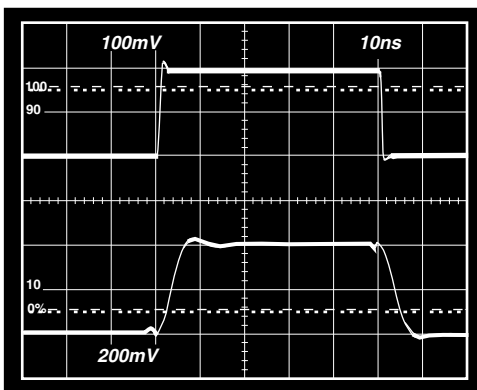

Figure 36. Noninverting Small Signal Pulse Response $\pm 5 V_S$, $C_F = 1 pF$, $R_L = 150 \Omega$

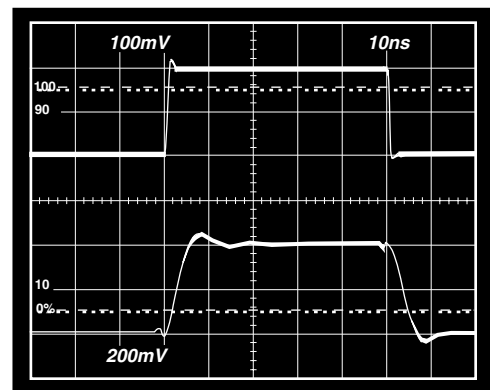

Figure 39. Noninverting Small Signal Pulse Response $\pm 5 V_S$, $C_F = 0 pF$, $R_L = 150 \Omega$

AD828

THEORY OF OPERATION

The AD828 is a low cost, dual video operational amplifier designed to excel in high performance, high output current video applications.

The AD828 (Figure 40) consists of a degenerated NPN differential pair driving matched PNP's in a folded-cascode gain stage. The output buffer stage employs emitter followers in a class AB amplifier that delivers the necessary current to the load while maintaining low levels of distortion.

The AD828 will drive terminated cables and capacitive loads of 10 pF or less. As the closed-loop gain is increased, the AD828 will drive heavier cap loads without oscillating.

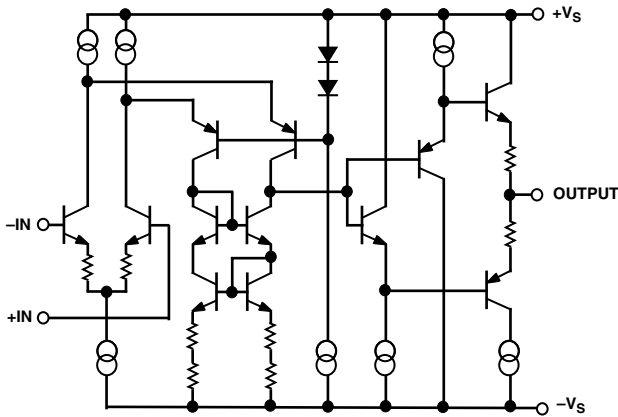

Figure 40. AD828 Simplified Schematic

INPUT CONSIDERATIONS

An input protection resistor (R_{IN} in Figure 34) is required in circuits where the input to the AD828 will be subjected to transient or continuous overload voltages exceeding the ± 6 V maximum differential limit. This resistor provides protection for the input transistors by limiting their maximum base current.

For high performance circuits, it is recommended that a “balancing” resistor be used to reduce the offset errors caused by bias current flowing through the input and feedback resistors. The balancing resistor equals the parallel combination of R_{IN} and R_F and thus provides a matched impedance at each input terminal. The offset voltage error will then be reduced by more than an order of magnitude.

APPLYING THE AD828

The AD828 is a breakthrough dual amp that delivers precision and speed at low cost with low power consumption. The AD828 offers excellent static and dynamic matching characteristics, combined with the ability to drive heavy resistive loads.

As with all high frequency circuits, care should be taken to maintain overall device performance as well as their matching. The following items are presented as general design considerations.

Circuit Board Layout

Input and output runs should be laid out so as to physically isolate them from remaining runs. In addition, the feedback resistor of each amplifier should be placed away from the feedback resistor of the other amplifier, since this greatly reduces interamp coupling.

Choosing Feedback and Gain Resistors

In order to prevent the stray capacitance present at each amplifier's summing junction from limiting its performance, the feedback resistors should be ≤ 1 k Ω . Since the summing junction capacitance may cause peaking, a small capacitor (1 pF–5 pF) may be paralleled with R_f to neutralize this effect. Finally, sockets should be avoided, because of their tendency to increase interlead capacitance.

Power Supply Bypassing

Proper power supply decoupling is critical to preserve the integrity of high frequency signals. In carefully laid out designs, decoupling capacitors should be placed in close proximity to the supply pins, while their lead lengths should be kept to a minimum. These measures greatly reduce undesired inductive effects on the amplifier's response.

Though two 0.1 μ F capacitors will typically be effective in decoupling the supplies, several capacitors of different values can be paralleled to cover a wider frequency range.

PARALLEL AMPS PROVIDE 100 mA TO LOAD

By taking advantage of the superior matching characteristics of the AD828, enhanced performance can easily be achieved by employing the circuit in Figure 41. Here, two identical cells are paralleled to obtain even higher load driving capability than that of a single amplifier (100 mA min guaranteed). R_1 and R_2 are included to limit current flow between amplifier outputs that would arise in the presence of any residual mismatch.

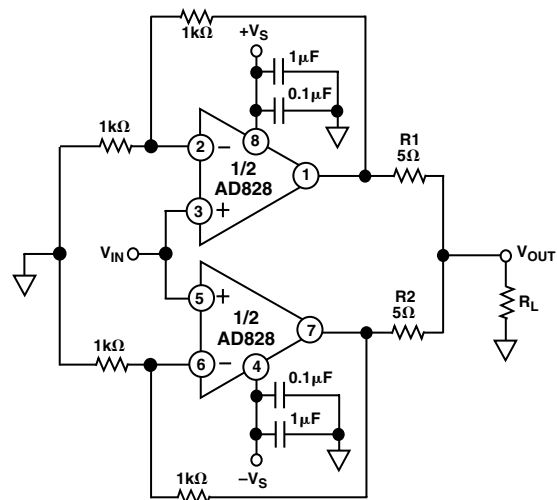

Figure 41. Parallel Amp Configuration

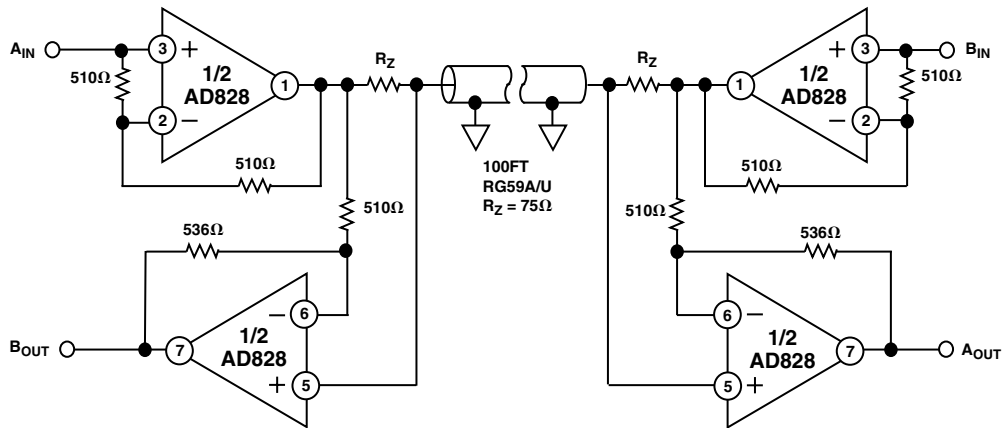

Figure 42. Bidirectional Transmission CKT

Full-Duplex Transmission

Superior load handling capability (50 mA min/amp), high bandwidth, wide supply voltage range and excellent crosstalk rejection makes the AD828 an ideal choice even for the most demanding high speed transmission applications.

The schematic below shows a pair of AD828s configured to drive 100 feet of coaxial cable in a full-duplex fashion.

Two different NTSC video signals are simultaneously applied at A_{IN} and B_{IN} and are recovered at A_{OUT} and B_{OUT}, respectively. This situation is illustrated in Figures 43 and 44. These pictures

clearly show that each input signal appears undisturbed at its output, while the unwanted signal is eliminated at either receiver.

The transmitters operate as followers, while the receivers' gain is chosen to take full advantage of the AD828's unparalleled CMRR. (In practice this gain is adjusted slightly from its theoretical value to compensate for cable nonidealities and losses.) R_Z is chosen to match the characteristic impedance of the cable employed.

Finally, although a coaxial cable was used, the same topology applies unmodified to a variety of cables (such, as twisted pairs often used in telephony).

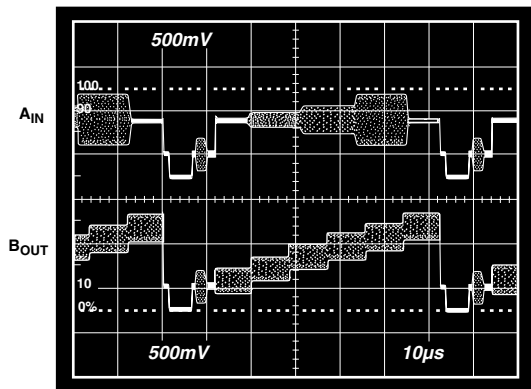

Figure 43. A Transmission/B Reception

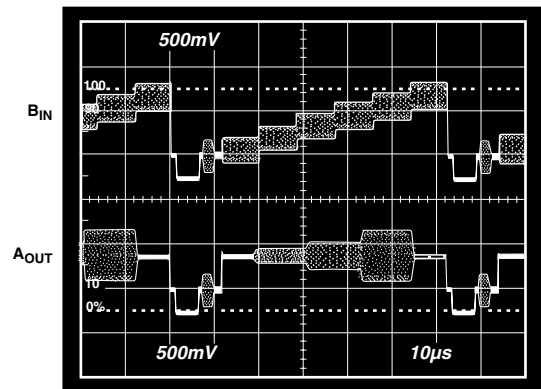

Figure 44. B Transmission/A Reception

A High Performance Video Line Driver

The buffer circuit shown in Figure 45 will drive a back-terminated 75 Ω video line to standard video levels (1 V p-p) with 0.1 dB gain flatness to 40 MHz with only 0.05° and 0.01% differential phase and gain at the 3.58 MHz NTSC subcarrier frequency. This level of performance, which meets the requirements for high-definition video displays and test equipment, is achieved using only 7 mA quiescent current/amplifier.

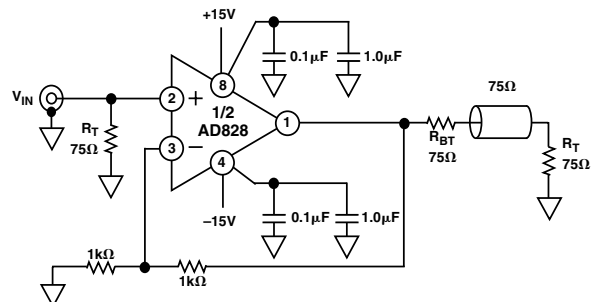

Figure 45. Video Line Driver

AD828

LOW DISTORTION LINE DRIVER

The AD828 can quickly be turned into a powerful, low distortion line driver (see Figure 46). In this arrangement the AD828 can comfortably drive a 75 Ω back-terminated cable, with a 5 MHz, 2 V p-p input; all of this while achieving the harmonic distortion performance outlined in the following table.

Configuration	2nd Harmonic
1. No Load	-78.5 dBm
2. 150 Ω R _L Only	-63.8 dBm
3. 150 Ω R _L 7.5 Ω R _C	-70.4 dBm

In this application one half of the AD828 operates at a gain of 2.1 and supplies the current to the load, while the other provides the overall system gain of 2. This is important for two reasons: the first is to keep the bandwidth of both amplifiers the same, and the second is to preserve the AD828's ability to operate from low supply voltage. R_C varies with the load and must be chosen to satisfy the following equation:

$$RC = MR_L$$

where *M* is defined by [(*M* + 1) G_S = G_D] and G_D = Driver's Gain, G_S = System Gain.

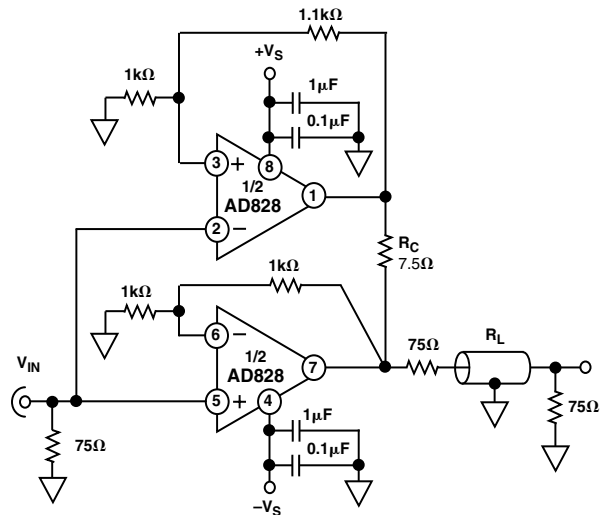
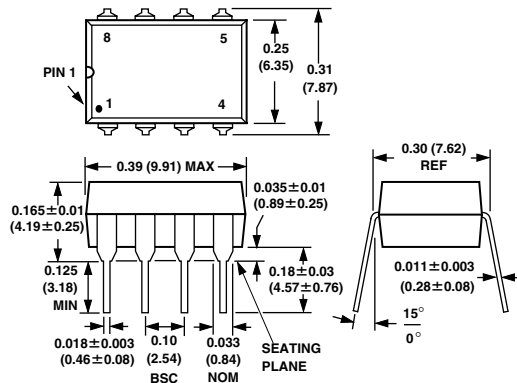

Figure 46. Low Distortion Amplifier

OUTLINE DIMENSIONS

Dimensions shown in inches and (mm).

8-Lead Plastic Mini-DIP (N) Package



8-Lead SO (R) Package

