

# FDP4020P/FDB4020P

## P-Channel 2.5V Specified Enhancement Mode Field Effect Transistor

### General Description

This P-Channel low threshold MOSFET has been designed for use as a linear pass element for low voltage outputs. In addition, the part may be used as a low voltage load switch when switching outputs on or off for power management. The part may also be used in conjunction with DC-DC converters requiring P-Channel.

### Features

- -16 A, -20 V.  $R_{DS(on)} = 0.08 \Omega @ V_{GS} = -4.5 \text{ V}$   
 $R_{DS(on)} = 0.11 \Omega @ V_{GS} = -2.5 \text{ V}$ .
- Critical DC electrical parameters specified at elevated temperature.
- High density cell design for extremely low  $R_{DS(on)}$ .
- TO-220 and TO-263 (D<sup>2</sup>PAK) package for both through hole and surface mount applications.
- 175°C maximum junction temperature rating.

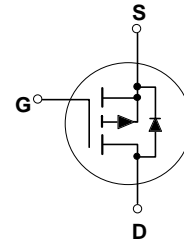
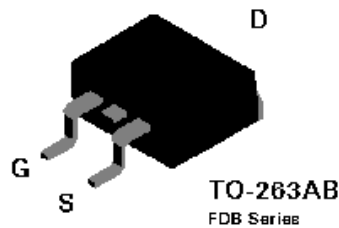
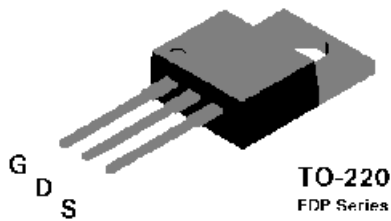

### Absolute Maximum Ratings T<sub>A</sub> = 25°C unless otherwise noted

Symbol	Parameter	FDP4020P	FDB4020P	Units
V <sub>DSS</sub>	Drain-Source Voltage	-20		V
V <sub>GSS</sub>	Gate-Source Voltage	±8		V
I <sub>D</sub>	Drain Current - Continuous	-16		A
	- Pulsed	-48		
P <sub>D</sub>	Total Power Dissipation @ T <sub>C</sub> = 25°C	37.5		W
	Derate above 25°C	0.25		W/°C
T <sub>J</sub> , T <sub>STG</sub>	Operating and Storage Junction Temperature Range	-65 to +175		°C

### Thermal Characteristics

R <sub>θJC</sub>	Thermal Resistance, Junction-to- Case	4		°C/W
R <sub>θJA</sub>	Thermal Resistance, Junction-to- Ambient (Note 1)	62.5	40	°C/W

### Package Outlines and Ordering Information

Device Marking	Device	Reel Size	Tape Width	Quantity
FDP4020P	FDP4020P	13"	12mm	2500 units

## Electrical Characteristics

$T_A = 25^\circ\text{C}$  unless otherwise noted

Symbol	Parameter	Test Conditions	Min	Typ	Max	Units
--------	-----------	-----------------	-----	-----	-----	-------

### Off Characteristics

$BV_{DSS}$	Drain-Source Breakdown Voltage	$V_{GS} = 0\text{ V}, I_D = -250\ \mu\text{A}$	-20			V
$\frac{\Delta BV_{DSS}}{\Delta T_J}$	Breakdown Voltage Temperature Coefficient	$I_D = -250\ \mu\text{A}$ , Referenced to $25^\circ\text{C}$		-28		$\text{mV}/^\circ\text{C}$
$I_{DSS}$	Zero Gate Voltage Drain Current	$V_{DS} = -16\text{ V}, V_{GS} = 0\text{ V}$			-1	$\mu\text{A}$
$I_{GSSF}$	Gate-Body Leakage Current, Forward	$V_{GS} = 8\text{ V}, V_{DS} = 0\text{ V}$			100	nA
$I_{GSSR}$	Gate-Body Leakage Current, Reverse	$V_{GS} = -8\text{ V}, V_{DS} = 0\text{ V}$			-100	nA

### On Characteristics (Note 2)

$V_{GS(th)}$	Gate Threshold Voltage	$V_{DS} = V_{GS}, I_D = -250\ \mu\text{A}$	-0.4	-0.58	-1	V
$\frac{\Delta V_{GS(th)}}{\Delta T_J}$	Gate Threshold Voltage Temperature Coefficient	$I_D = -250\ \mu\text{A}$ , Referenced to $25^\circ\text{C}$		2		$\text{mV}/^\circ\text{C}$
$R_{DS(on)}$	Static Drain-Source On-Resistance	$V_{GS} = -4.5\text{ V}, I_D = -8\text{ A}$ , $V_{GS} = -4.5\text{ V}, I_D = -8\text{ A}, T_J = 125^\circ\text{C}$ $V_{GS} = -2.5\text{ V}, I_D = -7\text{ A}$		0.068 0.098 0.096	0.08 0.13 0.110	$\Omega$
$I_{D(on)}$	On-State Drain Current	$V_{GS} = -4.5\text{ V}, V_{DS} = -5\text{ V}$	-20			A
$g_{FS}$	Forward Transconductance	$V_{DS} = -5\text{ V}, I_D = -8\text{ A}$		14		S

### Dynamic Characteristics

$C_{iss}$	Input Capacitance	$V_{DS} = -10\text{ V}, V_{GS} = 0\text{ V}$ , $f = 1.0\text{ MHz}$		665		pF
$C_{oss}$	Output Capacitance			270		pF
$C_{riss}$	Reverse Transfer Capacitance			70		pF

### Switching Characteristics (Note 2)

$t_{d(on)}$	Turn-On Delay Time	$V_{DD} = -5\text{ V}, I_D = -1\text{ A}$ , $V_{GS} = -4.5\text{ V}, R_{GEN} = 6\ \Omega$		8	16	ns
$t_r$	Turn-On Rise Time			24	38	ns
$t_{d(off)}$	Turn-Off Delay Time			50	80	ns
$t_f$	Turn-Off Fall Time			29	45	ns
$Q_g$	Total Gate Charge	$V_{DS} = -5\text{ V}$ , $I_D = -16\text{ A}, V_{GS} = -4.5\text{ V}$		9.5	13	nC
$Q_{gs}$	Gate-Source Charge			1.3		nC
$Q_{gd}$	Gate-Drain Charge			2.2		nC

### Drain-Source Diode Characteristics and Maximum Ratings

$I_S$	Maximum Continuous Drain-Source Diode Forward Current (Note 2)				-16	A
$I_{SM}$	Maximum Pulsed Drain-Source Diode Forward Current (Note 2)				-48	
$V_{SD}$	Drain-Source Diode Forward Voltage	$V_{GS} = 0\text{ V}, I_S = -16\text{ A}$ (Note 2)			-1.2	V

#### Notes:

- $R_{\theta JA}$  is the sum of the junction-to-case and case-to-ambient thermal resistance. For T0-263 the device is mounted on circuit board with a  $1\text{ in}^2$  pad of 2 oz. copper.
- Pulse Test: Pulse Width  $\leq 300\ \mu\text{s}$ , Duty Cycle  $\leq 2.0\%$

## Typical Characteristics

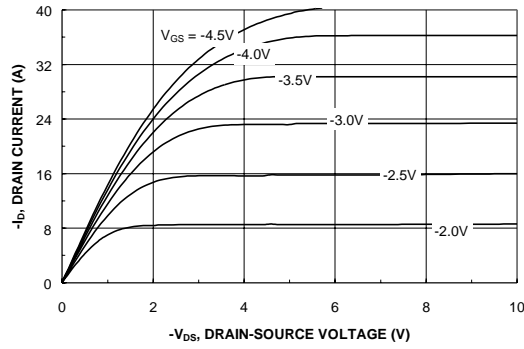

Figure 1. On-Region Characteristics.

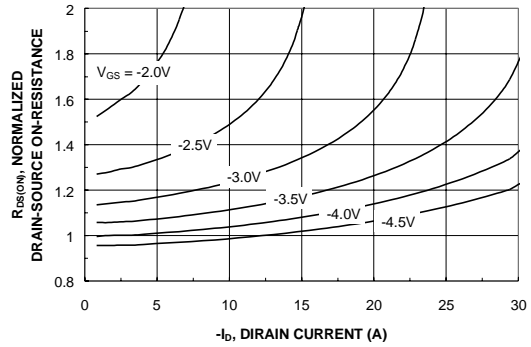

Figure 2. On-Resistance Variation with Drain Current and Gate Voltage.

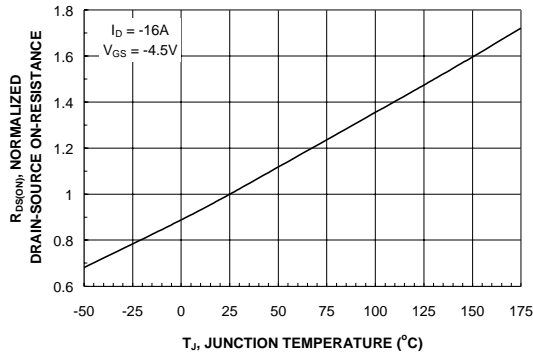

Figure 3. On-Resistance Variation with Temperature.

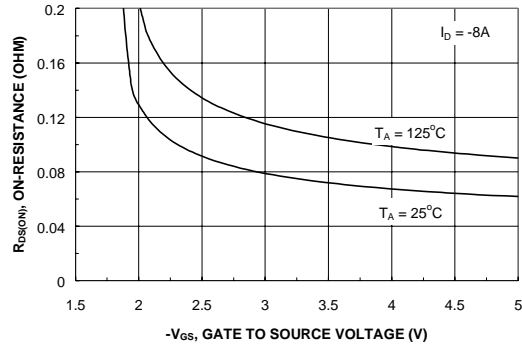

Figure 4. On-Resistance Variation with Gate-to-Source Voltage.

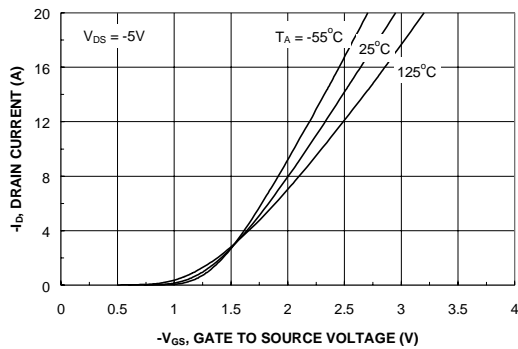

Figure 5. Transfer Characteristics.

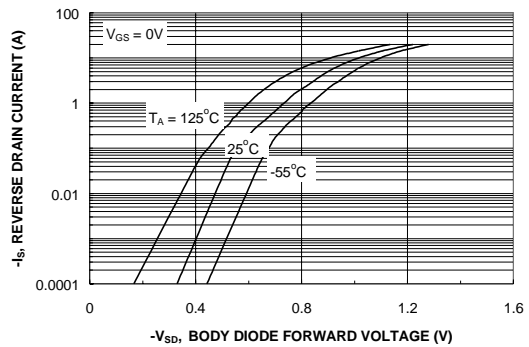

Figure 6. Body Diode Forward Voltage Variation with Source Current and Temperature.

Typical Characteristics (continued)

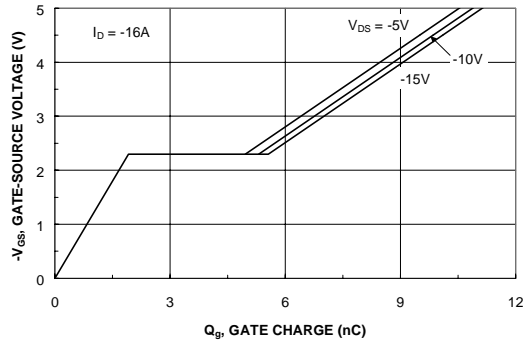

Figure 7. Gate-Charge Characteristics.

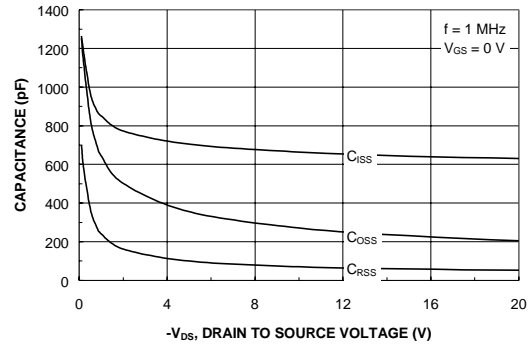

Figure 8. Capacitance Characteristics.

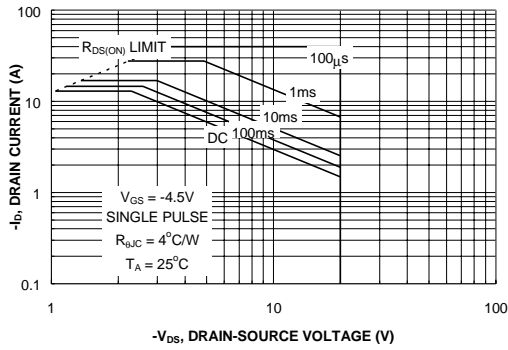

Figure 9. Maximum Safe Operating Area.

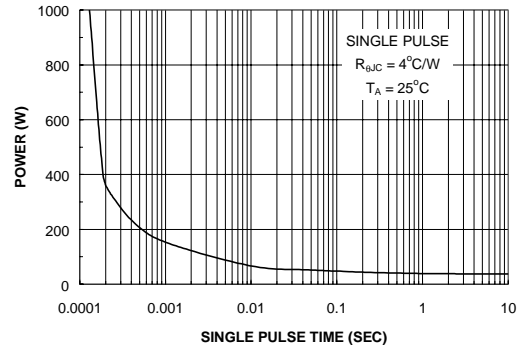

Figure 10. Single Pulse Maximum Power Dissipation.

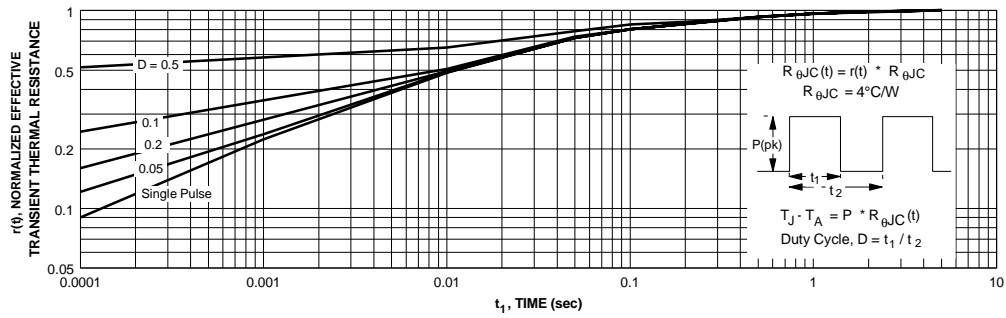

Figure 11. Transient Thermal Response Curve.

Thermal characterization performed using the conditions described in Note 1. Transient thermal response will change depending on the circuit board design.

# TO-220 Tape and Reel Data and Package Dimensions



## TO-220 Tube Packing Configuration: Figure 1.0

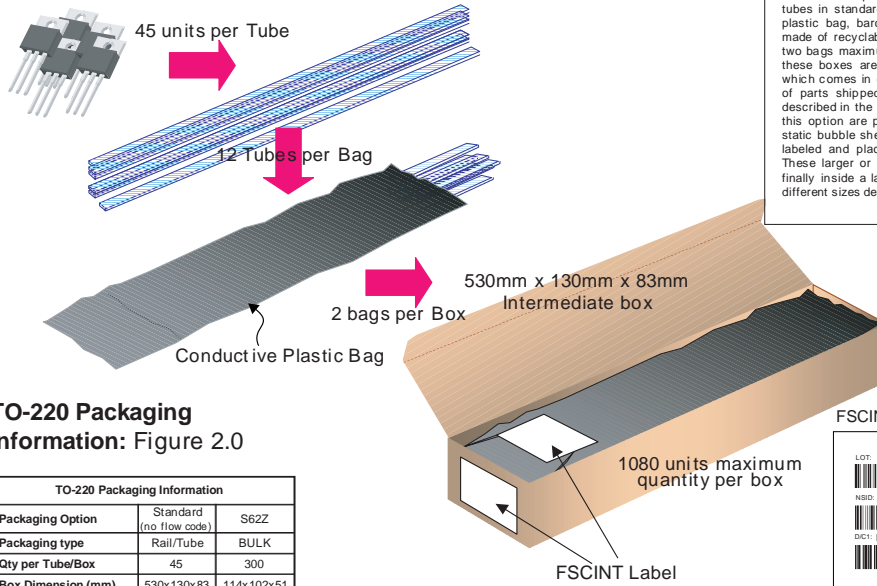

**Packaging Description:**  
 TO-220 parts are shipped normally in tube. The tube is made of PVC plastic treated with anti-static agent. These tubes in standard option are placed inside a dissipative plastic bag, barcode labeled, and placed inside a box made of recyclable corrugated paper. One box contains two bags maximum (see fig. 1.0). And one or several of these boxes are placed inside a labeled shipping box which comes in different sizes depending on the number of parts shipped. The other option comes in bulk as described in the Packaging Information table. The units in this option are placed inside a small box laid with anti-static bubble sheet. These smaller boxes are individually labeled and placed inside a larger box. (See fig. 3.0). These larger or intermediate boxes then will be placed finally inside a labeled shipping box which still comes in different sizes depending on the number of units shipped.

## TO-220 Packaging Information: Figure 2.0

TO-220 Packaging Information		
Packaging Option	Standard (no flow code)	S62Z
Packaging type	Reel/Tube	BULK
Qty per Tube/Box	45	300
Box Dimension (mm)	530x130x83	114x102x51
Max qty per Box	1,080	1,500
Weight per unit (gm)	1.4378	1.4378
Note/Comments		

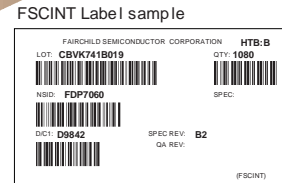

## TO-220 bulk Packing Configuration: Figure 3.0

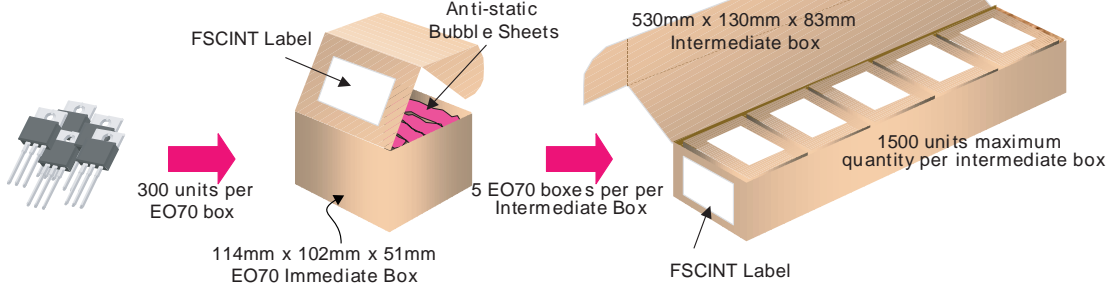

## TO-220 Tube Configuration: Figure 4.0

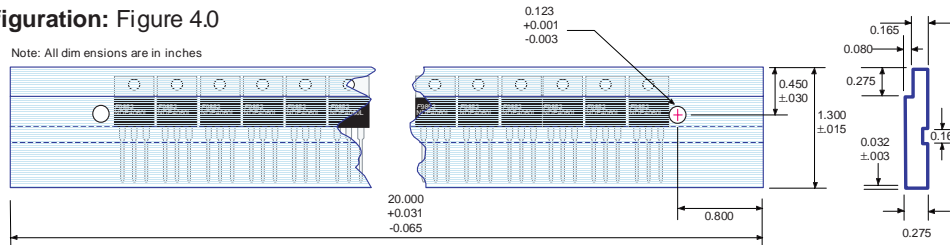

**TO-220 Tape and Reel Data and Package Dimensions, continued**

**TO-220 (FS PKG Code 37)**

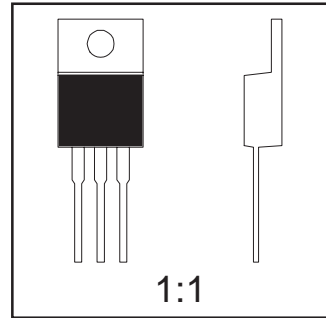
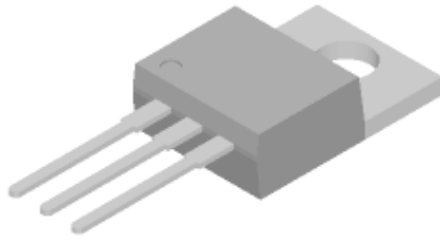

Scale 1:1 on letter size paper

Dimensions shown below are in:  
inches [millimeters]

Part Weight per unit (gram): 1.4378

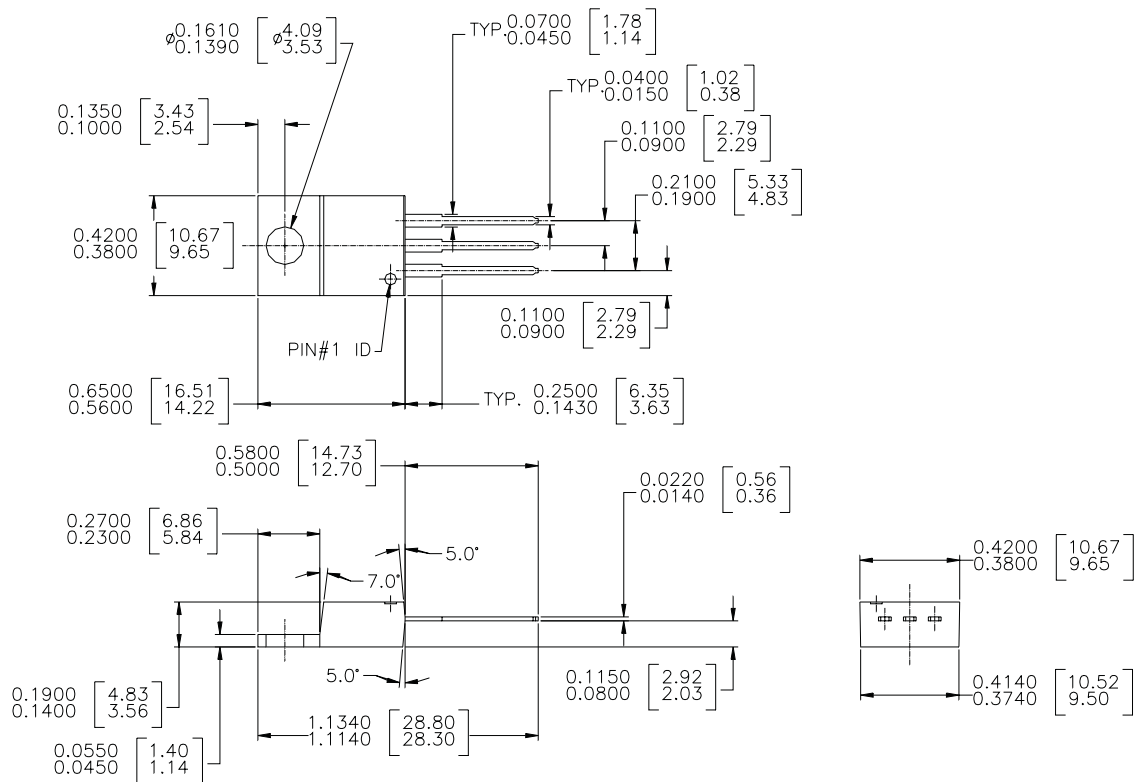

NOTE : UNLESS OTHERWISE SPECIFIED

1. STANDARD LEAD FINISH :  
200 MICROINCHES / 5.08 MICRON MINIMUM  
LEAD / TIN 15/85 ON OLIN 194 COPPER OR EQUIVALENT

2. DIMENSION BASED ON JEDEC STANDARD TO-220  
VARIATION AB, ISSUE J, DATED 3/24/87

TO 220 3 LEAD

## TRADEMARKS

The following are registered and unregistered trademarks Fairchild Semiconductor owns or is authorized to use and is not intended to be an exhaustive list of all such trademarks.

ACEx™	ISOPANAR™	TinyLogic™
CoolFET™	MICROWIRE™	UHC™
CROSSVOLT™	POP™	VCX™
E <sup>2</sup> CMOS™	PowerTrench™	
FACT™	QFET™	
FACT Quiet Series™	QS™	
FAST®	Quiet Series™	
FASTr™	SuperSOT™-3	
GTO™	SuperSOT™-6	
HiSeC™	SuperSOT™-8	

## DISCLAIMER

FAIRCHILD SEMICONDUCTOR RESERVES THE RIGHT TO MAKE CHANGES WITHOUT FURTHER NOTICE TO ANY PRODUCTS HEREIN TO IMPROVE RELIABILITY, FUNCTION OR DESIGN. FAIRCHILD DOES NOT ASSUME ANY LIABILITY ARISING OUT OF THE APPLICATION OR USE OF ANY PRODUCT OR CIRCUIT DESCRIBED HEREIN; NEITHER DOES IT CONVEY ANY LICENSE UNDER ITS PATENT RIGHTS, NOR THE RIGHTS OF OTHERS.

## LIFE SUPPORT POLICY

FAIRCHILD'S PRODUCTS ARE NOT AUTHORIZED FOR USE AS CRITICAL COMPONENTS IN LIFE SUPPORT DEVICES OR SYSTEMS WITHOUT THE EXPRESS WRITTEN APPROVAL OF FAIRCHILD SEMICONDUCTOR CORPORATION. As used herein:

1. Life support devices or systems are devices or systems which, (a) are intended for surgical implant into the body, or (b) support or sustain life, or (c) whose failure to perform when properly used in accordance with instructions for use provided in the labeling, can be reasonably expected to result in significant injury to the user.
2. A critical component is any component of a life support device or system whose failure to perform can be reasonably expected to cause the failure of the life support device or system, or to affect its safety or effectiveness.

## PRODUCT STATUS DEFINITIONS

### Definition of Terms

Datasheet Identification	Product Status	Definition
Advance Information	Formative or In Design	This datasheet contains the design specifications for product development. Specifications may change in any manner without notice.
Preliminary	First Production	This datasheet contains preliminary data, and supplementary data will be published at a later date. Fairchild Semiconductor reserves the right to make changes at any time without notice in order to improve design.
No Identification Needed	Full Production	This datasheet contains final specifications. Fairchild Semiconductor reserves the right to make changes at any time without notice in order to improve design.
Obsolete	Not In Production	This datasheet contains specifications on a product that has been discontinued by Fairchild semiconductor. The datasheet is printed for reference information only.