

IRF7523D1

FETKY™ MOSFET / Schottky Diode

- Co-packaged HEXFET® Power MOSFET and Schottky Diode
- N-Channel HEXFET
- Low V_F Schottky Rectifier
- Generation 5 Technology
- Micro8™ Footprint

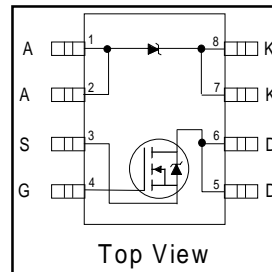

$V_{DSS} = 30V$
$R_{DS(on)} = 0.11\Omega$
Schottky $V_f = 0.39V$

Description

The FETKY™ family of co-packaged HEXFETs and Schottky diodes offer the designer an innovative board space saving solution for switching regulator applications. Generation 5 HEXFETs utilize advanced processing techniques to achieve extremely low on-resistance per silicon area. Combining this technology with International Rectifier's low forward drop Schottky rectifiers results in an extremely efficient device suitable for use in a wide variety of portable electronics applications like cell phone, PDA, etc.

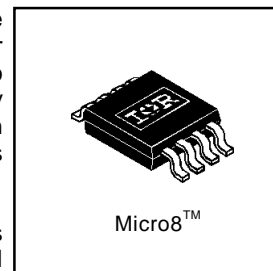

The new Micro8™ package, with half the footprint area of the standard SO-8, provides the smallest footprint available in an SOIC outline. This makes the Micro8™ an ideal device for applications where printed circuit board space is at a premium. The low profile (<1.1mm) of the Micro8™ will allow it to fit easily into extremely thin application environments such as portable electronics and PCMCIA cards.

Absolute Maximum Ratings ($T_A = 25^\circ C$ unless otherwise noted)

Parameter		Maximum	Units
$I_D @ T_A = 25^\circ C$	Continuous Drain Current, $V_{GS}@10V^{(4)}$	2.7	A
$I_D @ T_A = 70^\circ C$		2.1	
I_{DM}	Pulsed Drain Current ⁽¹⁾	21	
$P_D @ T_A = 25^\circ C$	Power Dissipation ⁽⁴⁾	1.25	W
$P_D @ T_A = 70^\circ C$		0.8	
	Linear Derating Factor	10	W/°C
V_{GS}	Gate-to-Source Voltage	± 20	V
dv/dt	Peak Diode Recovery dv/dt ⁽²⁾	6.2	V/ns
T_J, T_{STG}	Junction and Storage Temperature Range	-55 to +150	°C

Thermal Resistance Ratings

Parameter		Maximum	Units
$R_{\theta JA}$	Junction-to-Ambient ⁽⁴⁾	100	°C/W

Notes:

- ① Repetitive rating; pulse width limited by maximum junction temperature (see figure 11)
- ② $I_{SD} \leq 1.7A$, $di/dt \leq 120A/\mu s$, $V_{DD} \leq V_{(BR)DSS}$, $T_J \leq 150^\circ C$
- ③ Pulse width $\leq 300\mu s$; duty cycle $\leq 2\%$
- ④ When mounted on 1 inch square copper board to approximate typical multi-layer PCB thermal resistance

MOSFET Electrical Characteristics @ T_J = 25°C (unless otherwise specified)

Parameter		Min.	Typ.	Max.	Units	Conditions
V _{(BR)DSS}	Drain-to-Source Breakdown Voltage	30	—	—	V	V _{GS} = 0V, I _D = 250μA
R _{DS(on)}	Static Drain-to-Source On-Resistance	—	0.090	0.130	Ω	V _{GS} = 10V, I _D = 1.7A ③
		—	0.140	0.190		V _{GS} = 4.5V, I _D = 0.85A ③
V _{GS(th)}	Gate Threshold Voltage	1.0	—	—	V	V _{DS} = V _{GS} , I _D = 250μA
g _{fs}	Forward Transconductance	1.9	—	—	S	V _{DS} = 10V, I _D = 0.85A
I _{DSS}	Drain-to-Source Leakage Current	—	—	1.0	μA	V _{DS} = 24V, V _{GS} = 0V
		—	—	25		V _{DS} = 24V, V _{GS} = 0V, T _J = 125°C
I _{GSS}	Gate-to-Source Forward Leakage	—	—	-100	nA	V _{GS} = -20V
	Gate-to-Source Reverse Leakage	—	—	100		V _{GS} = 20V
Q _g	Total Gate Charge	—	7.8	12	nC	I _D = 1.7A
Q _{gs}	Gate-to-Source Charge	—	1.2	1.8		V _{DS} = 24V
Q _{gd}	Gate-to-Drain ("Miller") Charge	—	2.5	3.8		V _{GS} = 10V (see figure 6) ③
t _{d(on)}	Turn-On Delay Time	—	4.7	—	ns	V _{DD} = 15V
t _r	Rise Time	—	10	—		I _D = 1.7A
t _{d(off)}	Turn-Off Delay Time	—	12	—		R _G = 6.1Ω
t _f	Fall Time	—	5.3	—		R _D = 8.7Ω ③
C _{iss}	Input Capacitance	—	210	—	pF	V _{GS} = 0V
C _{oss}	Output Capacitance	—	80	—		V _{DS} = 25V
C _{riss}	Reverse Transfer Capacitance	—	32	—		f = 1.0MHz (see figure 5)

MOSFET Source-Drain Ratings and Characteristics

Parameter		Min.	Typ.	Max.	Units	Conditions
I _S	Continuous Source Current (Body Diode)	—	—	1.25	A	
I _{SM}	Pulsed Source Current (Body Diode)	—	—	21		
V _{SD}	Body Diode Forward Voltage	—	—	1.2	V	T _J = 25°C, I _S = 1.7A, V _{GS} = 0V
t _{rr}	Reverse Recovery Time (Body Diode)	—	40	60	ns	T _J = 25°C, I _F = 1.7A
Q _{rr}	Reverse Recovery Charge	—	48	72	nC	di/dt = 100A/μs ③

Schottky Diode Maximum Ratings

	Parameter	Max.	Units	Conditions
I _{F(av)}	Max. Average Forward Current	1.9	A	50% Duty Cycle. Rectangular Wave, T _A = 25°C
		1.3		See Fig.14 T _A = 70°C
I _{SM}	Max. peak one cycle Non-repetitive Surge current	120	A	5μs sine or 3μs Rect. pulse
		11		10ms sine or 6ms Rect. pulse
				Following any rated load condition & with V _{RSM} applied

Schottky Diode Electrical Specifications

	Parameter	Max.	Units	Conditions
V _{FM}	Max. Forward voltage drop	0.50	V	I _F = 1.0A, T _J = 25°C
		0.62		I _F = 2.0A, T _J = 25°C
		0.39		I _F = 1.0A, T _J = 125°C
		0.57		I _F = 2.0A, T _J = 125°C
I _{RM}	Max. Reverse Leakage current	0.06	mA	V _R = 30V, T _J = 25°C
		16		T _J = 125°C
C _t	Max. Junction Capacitance	92	pF	V _R = 5Vdc (100kHz to 1 MHz) 25°C
dv/dt	Max. Voltage Rate of Charge	3600	V/ μs	Rated V _R

Power Mosfet Characteristics

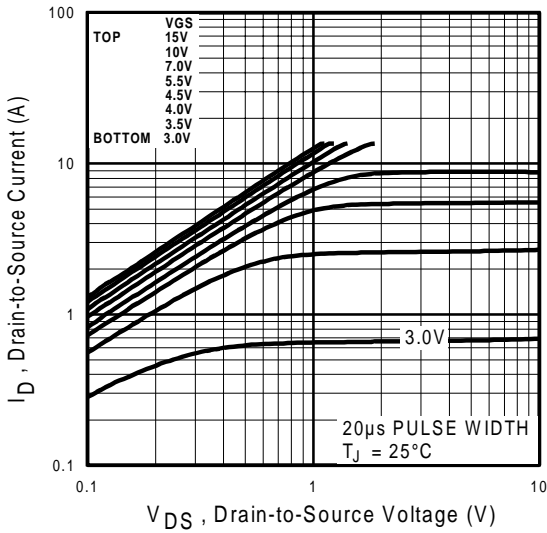

Fig 1. Typical Output Characteristics

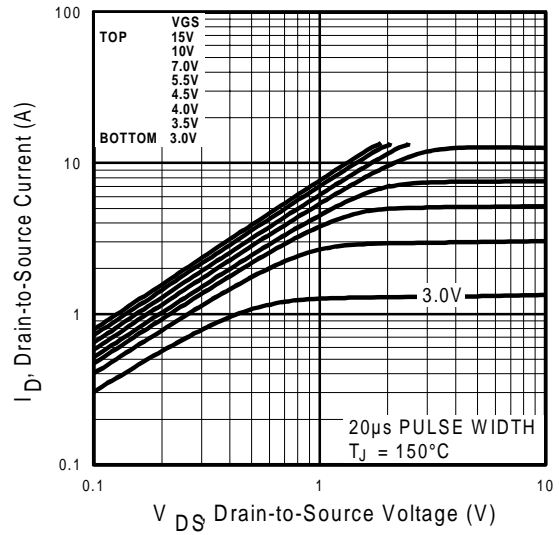

Fig 2. Typical Output Characteristics

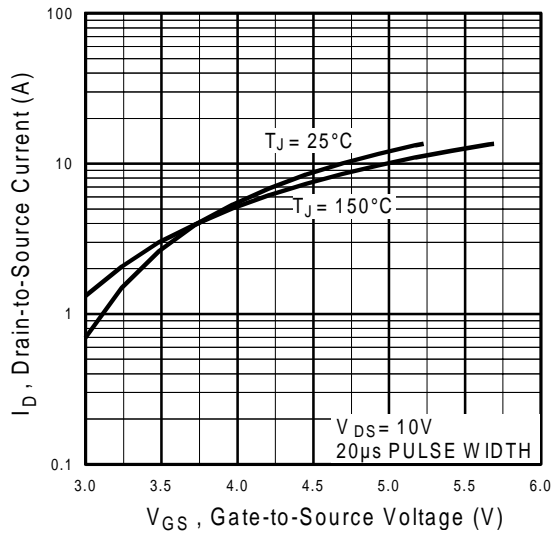

Fig 3. Typical Transfer Characteristics

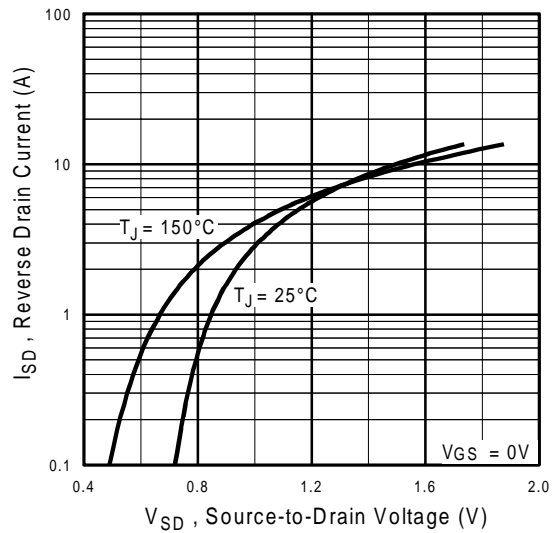

Fig 4. Typical Source-Drain Diode Forward Voltage

Power Mosfet Characteristics

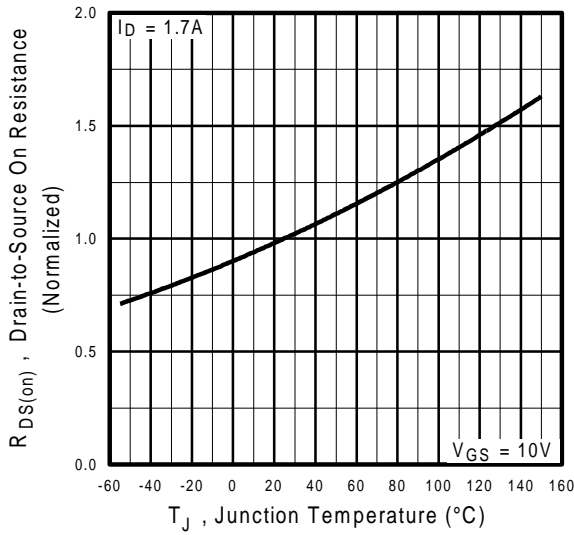

Fig 5. Normalized On-Resistance Vs. Temperature

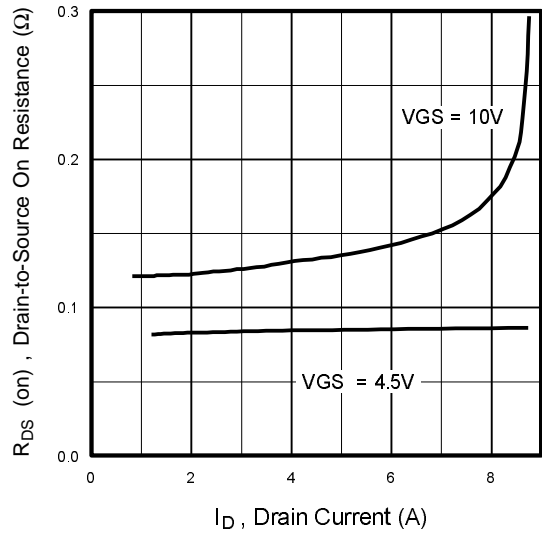

Fig 6. Typical On-Resistance Vs. Drain Current

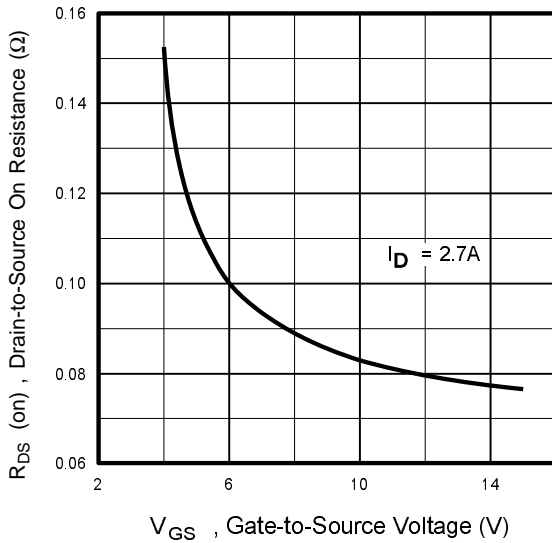

Fig 7. Typical On-Resistance Vs. Gate Voltage

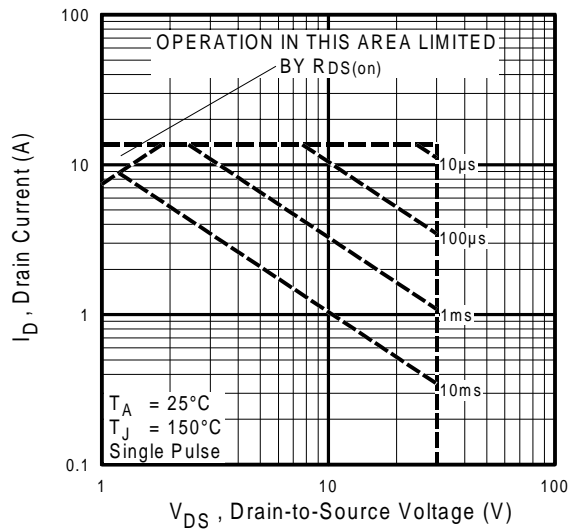

Fig 8. Maximum Safe Operating Area

Power Mosfet Characteristics

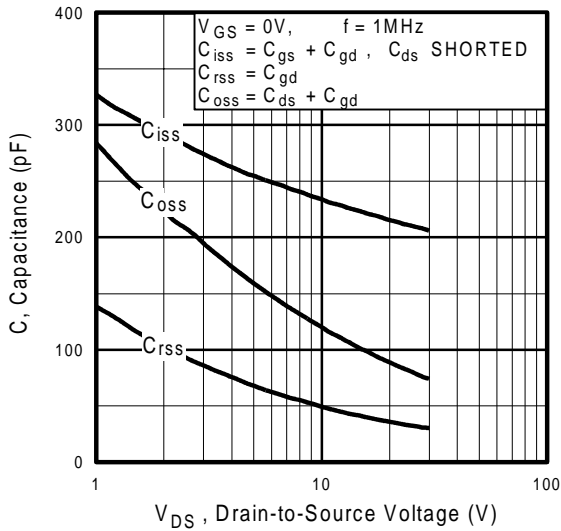

Fig 9. Typical Capacitance Vs. Drain-to-Source Voltage

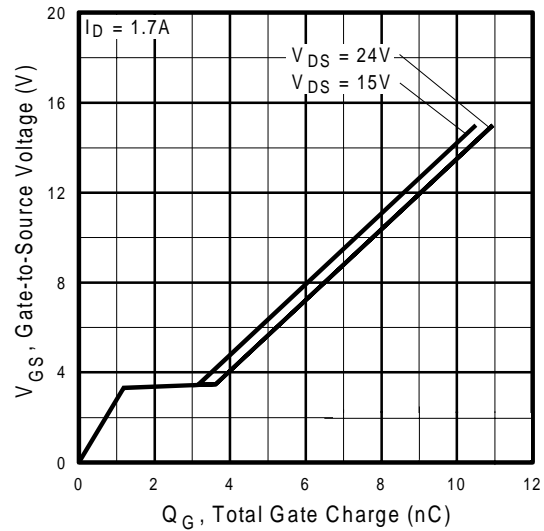

Fig 10. Typical Gate Charge Vs. Gate-to-Source Voltage

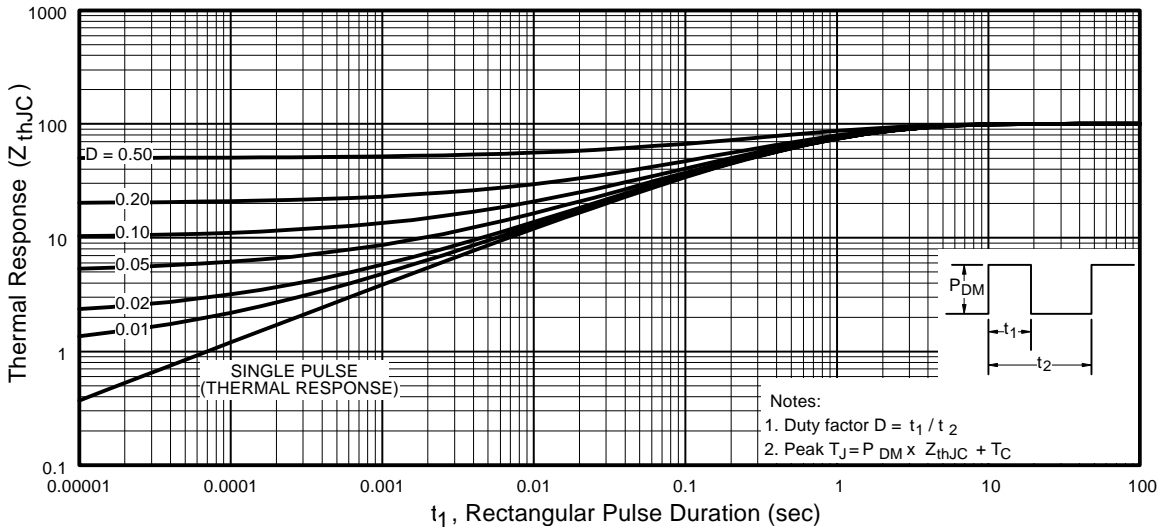

Fig 11. Maximum Effective Transient Thermal Impedance, Junction-to-Ambient

Schottky Diode Characteristics

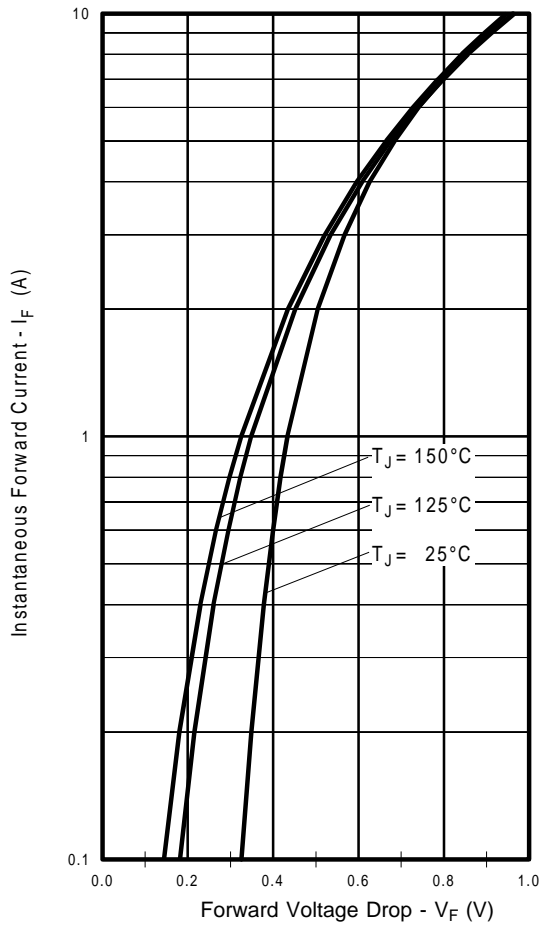

Fig. 12 -Typical Forward Voltage Drop Characteristics

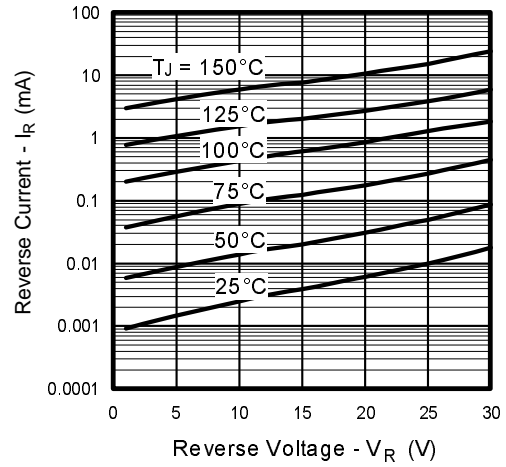

Fig. 13 - Typical Values of Reverse Current Vs. Reverse Voltage

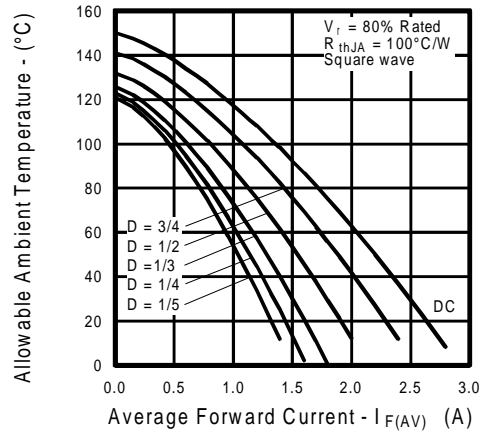
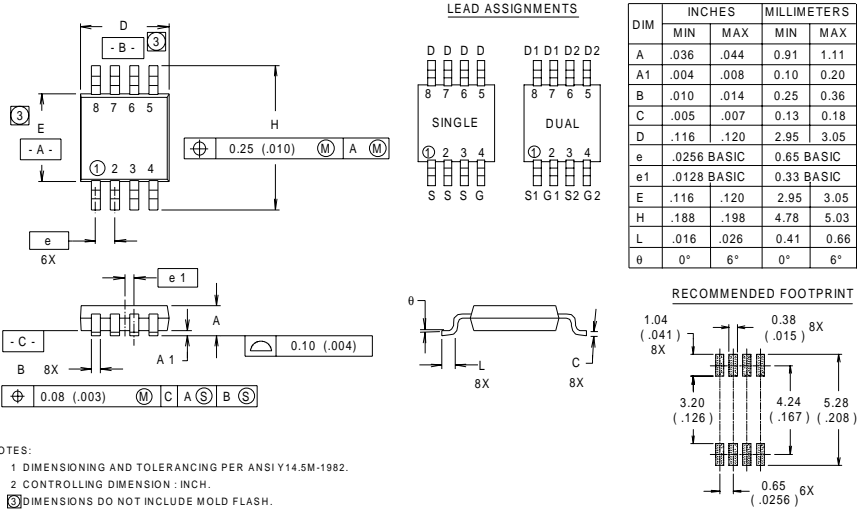

Fig.14 - Maximum Allowable Ambient Temp. Vs. Forward Current

Micro8™ Package Details



Part Marking

EXAMPLE: THIS IS AN IRF7501

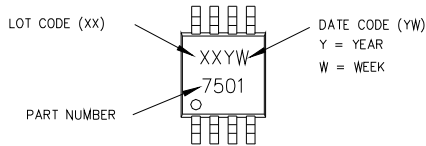

WW = (1-26) IF PRECEDED BY LAST DIGIT OF CALENDAR YEAR

DATE CODE EXAMPLES:

YWW = 9503 = 5C
 YWW = 9532 = EF

YEAR	Y	WORK WEEK	W
2001	1	01	A
2002	2	02	B
2003	3	03	C
1994	4	04	D
1995	5		
1996	6		
1997	7		
1998	8		
1999	9		
2000	0	24	X
		25	Y
		26	Z

WW = (27-52) IF PRECEDED BY A LETTER

YEAR	Y	WORK WEEK	W
2001	A	27	A
2002	B	28	B
2003	C	29	C
1994	D	30	D
1995	E		
1996	F		
1997	G		
1998	H		
1999	J		
2000	K	50	X
		51	Y
		52	Z

IRF7523D1

International
IR Rectifier

Micro8™ Tape & Reel

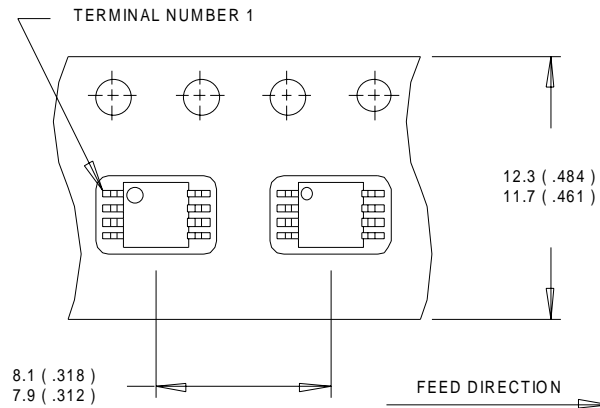

- NOTES:
1. OUTLINE CONFORMS TO EIA-481 & EIA-541.
 2. CONTROLLING DIMENSION : MILLIMETER.

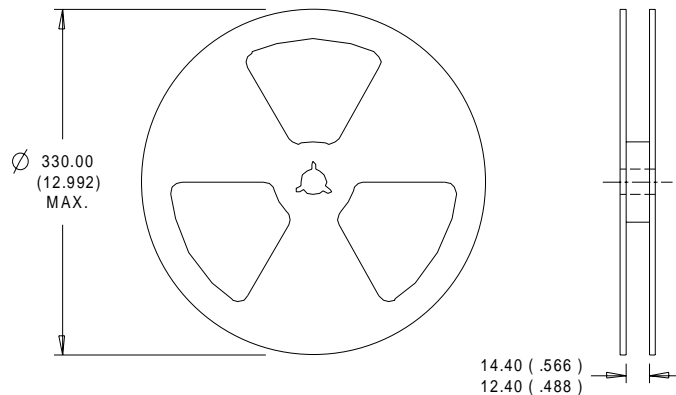

- NOTES :
1. CONTROLLING DIMENSION : MILLIMETER.
 2. OUTLINE CONFORMS TO EIA-481 & EIA-541.

International
IR Rectifier

WORLD HEADQUARTERS: 233 Kansas St., El Segundo, California 90245, Tel: (310) 322 3331

IR GREAT BRITAIN: Hurst Green, Oxted, Surrey RH8 9BB, UK Tel: ++ 44 1883 732020

IR CANADA: 15 Lincoln Court, Brampton, Ontario L6T3Z2, Tel: (905) 453 2200

IR GERMANY: Saalburgstrasse 157, 61350 Bad Homburg Tel: ++ 49 6172 96590

IR ITALY: Via Liguria 49, 10071 Borgaro, Torino Tel: ++ 39 11 451 0111

IR FAR EAST: K&H Bldg., 2F, 30-4 Nishi-Ikebukuro 3-Chome, Toshima-Ku, Tokyo Japan 171 Tel: 81 3 3983 0086

IR SOUTHEAST ASIA: 1 Kim Seng Promenade, Great World City West Tower, 13-11, Singapore 237994 Tel: ++ 65 221 8371

IR TAIWAN: 16 Fl. Suite D. 207, Sec. 2, Tun Haw South Road, Taipei, 10673, Taiwan Tel: 886-2-2377-9936

<http://www.irf.com/> Data and specifications subject to change without notice . 3/99