



LC99012A-S

Black-and-White CCD Timing Generator

Preliminary

Overview

The LC99012A-S is a timing generator for the 1/5-inch LC9947G and LC9948G and the 1/6-inch LC9949G black-and-white CCD image sensors.

Features

- 5 V single-voltage power supply
- Generates all pulses required for CCD drivers.
- Generates all pulses required for video signal processing.
- Built-in synchronizing signal generator that supports both EIA and CCIR.
- Includes buffer circuits for directly driving the CCD horizontal transfer and reset gates.
- Includes light metering and control systems for an automatic electronic iris function.
- Fixed rate-of-change control allows a smooth electronic iris function to be implemented (an iris state output is provided).
- Supports AGC control and a light metering mode that compensates for backlighting.
- Selectable CCD storage mode (non-interlaced or interlaced)
- Selectable TV scan mode (non-interlaced or interlaced)
- Allows all types of external synchronization.
- Built-in EXT-C.SYNC sync separator circuit
- Built-in phase comparator for external synchronization
- Control from external electronic shutter pulses and frame shift pulses supports one-shot imaging.
- Package: 0.5 mm lead pitch flat package (SQFP-64)
- Flickerless function
- Sensitivity-increasing function

Package Dimensions

unit: mm

3190-SQFP64

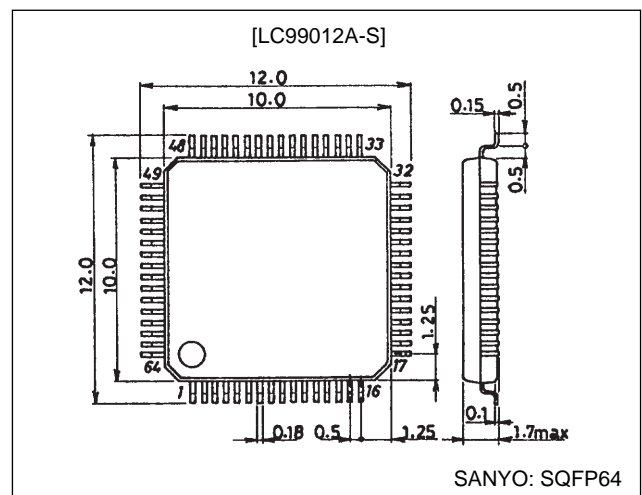

Specifications

Absolute Maximum Ratings at $V_{SS} = 0\text{ V}$

Parameter	Symbol	Conditions	Ratings	Unit
Maximum supply voltage	$V_{DD\text{ max}}$		-0.3 to +7.0	V
Input and output voltages	V_I, V_O		-0.3 to $V_{DD} + 0.3$	V
Allowable power dissipation	$P_d\text{ max}$	$T_a \leq 65^\circ\text{C}$	290	mW
Operating temperature	T_{opr}		-30 to +65	$^\circ\text{C}$
Storage temperature	T_{stg}		-55 to +125	$^\circ\text{C}$
Soldering heat resistance		Hand soldering: 3 seconds	350	$^\circ\text{C}$
		Reflow soldering: 10 seconds	235	$^\circ\text{C}$
Input and output currents	I_I, I_O		$\pm 20^*$	mA

Note: * Per individual I/O reference cell

Allowable Operating Ranges at $T_a = -30\text{ to }+65^\circ\text{C}$, $V_{SS} = 0\text{ V}$

Parameter	Symbol	Conditions	min	typ	max	Unit
Supply voltage	V_{DD}		4.5	5.0	5.5	V
Input voltage range	V_{IN}		0		V_{DD}	V

DC Characteristics: Input and Output Levels at $V_{SS} = 0\text{ V}$, $V_{DD} = 4.5\text{ to }5.5\text{ V}$, $T_a = -30\text{ to }+65^\circ\text{C}$

See the note on next page.

Parameter	Symbol	Conditions	min	typ	max	Unit
Input high-level voltage	V_{IH1}	TTL levels: (6)	2.2			V
Input low-level voltage	V_{IL1}	TTL levels: (6)			0.8	V
Input high-level voltage	V_{IH2}	CMOS levels: (1), (3)	$0.7 V_{DD}$			V
Input low-level voltage	V_{IL2}	CMOS levels: (1), (3)			$0.3 V_{DD}$	V
Input high-level voltage	V_{IH3}	CMOS levels, Schmitt inputs: (4)	$0.8 V_{DD}$			V
Input low-level voltage	V_{IL3}	CMOS levels, Schmitt inputs: (4)			$0.2 V_{DD}$	V
Input high-level voltage	V_{IH4}	CMOS levels, inputs with pull-up resistors: (2)	$0.7 V_{DD}$			V
Input low-level voltage	V_{IL4}	CMOS levels, inputs with pull-up resistors: (2)			$0.3 V_{DD}$	V
Input high-level voltage	V_{IH5}	CMOS levels, inputs with pull-up resistors: (5)	$0.7 V_{DD}$			V
Input low-level voltage	V_{IL5}	CMOS levels, inputs with pull-up resistors: (5)			$0.3 V_{DD}$	V
Output high-level voltage	V_{OH1}	$I_{OH} = -3\text{ mA}$: (6), (13), (14), (15)	$V_{SS} - 2.1$			V
Output low-level voltage	V_{OL1}	$I_{OL} = 3\text{ mA}$: (6), (13), (14), (15)			0.4	V
Output low-level voltage	V_{OL2}	$I_{OL} = 3\text{ mA}$: (9)			0.4	V
Output high-level voltage	V_{OH3}	$I_{OH} = -6\text{ mA}$: (12)	$V_{DD} - 2.1$			V
Output low-level voltage	V_{OL3}	$I_{OL} = 6\text{ mA}$: (12)			0.4	V
Output high-level voltage	V_{OH4}	$I_{OH} = -6\text{ mA}$: (7)	$V_{DD} - 2.1$			V
Output low-level voltage	V_{OL4}	$I_{OL} = 2\text{ mA}$: (7)			0.4	V
Output high-level voltage	V_{OH5}	$I_{OH} = -30\text{ mA}$: (11)	$V_{DD} - 2.1$			V
Output low-level voltage	V_{OL5}	$I_{OL} = 10\text{ mA}$: (11)			0.4	V
Output high-level voltage	V_{OH6}	$I_{OH} = -12\text{ mA}$: (8)	$V_{DD} - 2.1$			V
Output low-level voltage	V_{OL6}	$I_{OL} = 12\text{ mA}$: (8)			0.4	V
Output high-level voltage	V_{OH6}	$I_{OH} = -12\text{ mA}$: (10)	$V_{DD} - 1.5$			V
Output low-level voltage	V_{OL7}	$I_{OL} = 6\text{ mA}$: (8)			0.4	V
Input leakage current	I_{IL}	$V_I = V_{SS}, V_{DD}$: (1), (3), (4), (6)	-10		+10	μA
Output leakage current	I_{OZ}	In high-impedance output mode: (6), (9), (13)	-10		+10	μA
Pull-up resistance	R_{UP}	(2)	10	20	40	$\text{k}\Omega$
Pull-down resistance	R_{DN}	(5)	25	50	100	$\text{k}\Omega$

LC99012A-S

Note: The applicable pin sets are defined as follows:

Input

- (1)AI, CKI
- (2)FLESS, STR, TEST
- (3)EXT1, EXT2, KISYU, TV
- (4)HR, SELMET1, SELMET2, VR
- (5)CCDSCAN, EXT3, EXT4, MSENS, SENS, SSGSCAN

I/O

- (6)STEPSTOP

Output

- (7)PCO
- (8)DHTR
- (9)IRRES
- (10)A0, CKO
- (11)DHT1, DHT2
- (12)DS1, DS2
- (13)AGCC2, IRSTA
- (14)CLK14M, CLP1, CLP2, FLD, HD, NSUB1, NSUB2, VD
- (15)CBLK, C.SYNC, NSUB3, PBLK, V11 to V14, VS1 to VS4

*VIDI, VIDO, DCH, DCL, IRIS (These pins are not covered in the DC characteristics.)

Pin Assignment

I/O → I: Input pin, O: Output pin, B: Bidirectional pin, P: Power supply pin, NC: Unconnected pin

No.	Symbol	I/O	No.	Symbol	I/O
1	V _{SS}	P	64	DCL	I
2	PCO	O	63	DCH	I
3	AI	I	62	IRIS	I
4	AO	O	61	IRRES	O
5	CKI	I	60	VIDO	O
6	CKO	O	59	VIDI	I
7	CCDSCAN	I	58	IRSTA	O
8	SSGSCAN	I	57	AGCC2	O
9	CLK14M	O	56	V _{DD}	P
10	HD	O	55	TV	I
11	VD	O	54	C.SYNC	O
12	FLD	O	53	CBLK	O
13	V _{DD}	P	52	PBLK	O
14	KISYU	I	51	CLP2	O
15	HR	I	50	CLP1	O
16	VR	I	49	V _{SS}	P
17	V _{SS}	P	48	DS1	O
18	SELMET1	I	47	DS2	O
19	SELMET2	I	46	V _{DD}	P
20	EXT1	I	45	DHT2	O
21	EXT2	I	44	DHT1	O
22	EXT3	I	43	DHTR	O
23	EXT4	I	42	V _{SS}	P
24	V _{DD}	P	41	VS3	O
25	STEPSTOP	B	40	VS2	O
26	SENS	I	39	VS1	O
27	MSENS	I	38	VS4	O
28	FLESS	I	37	V14	O
29	STR	I	36	V12	O
30	NSUB3	O	35	V13	O
31	NSUB2	O	34	V11	O
32	NSUB1	O	33	TEST	I

Note: All V_{DD} and V_{SS} pins must be connected to the power supply or ground. Do not leave any of these pins open.

LC99012A-S

Block Diagram

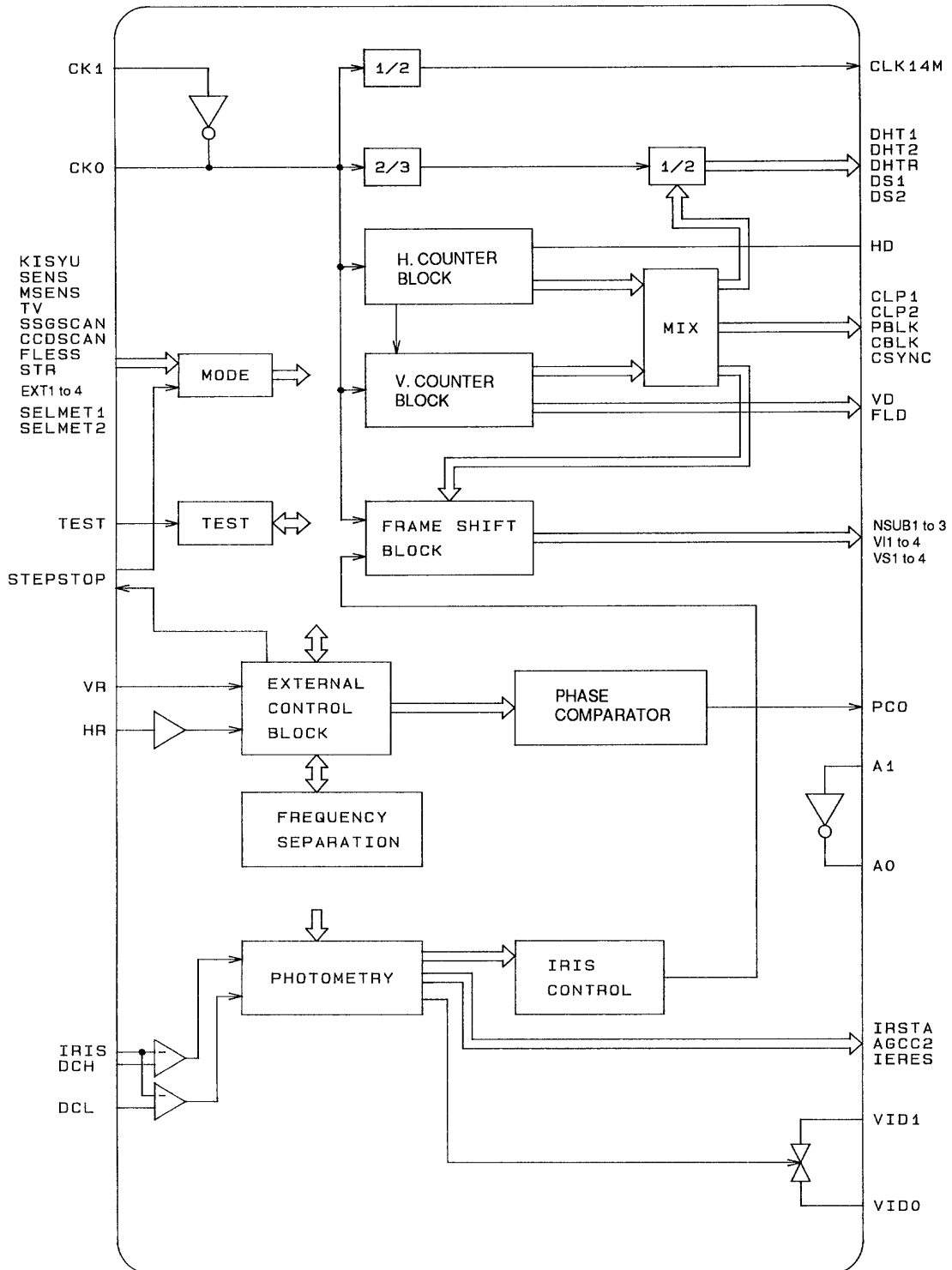

A04739

LC99012A-S





Pin Functions

Pin No.	Symbol	I/O	Function
1	GND		
2	PCO	O	Phase comparator output
3	AI	I	PCO output signal low-pass filter amplifier input
4	AO	O	PCO output signal low-pass filter amplifier output
5	CKI	I	Reference clock input (resonator inverter input) LC9947G: 28.63636 MHz LC9948G: 28.375 MHz LC9949G: 14.31818 MHz
6	CKO	O	Resonator inverter output
7	CCDSCAN	I	Low/open: CCD interlaced storage mode High: CCD non-interlaced storage mode
8	SSGSCAN	I	Low/open: C.SYNC interlaced mode High: C.SYNC non-interlaced mode
9	CLK14M	O	LC9947G/9949G: 14.31818 MHz LC9948G: 14.1875 MHz
10	HD	O	HD output
11	VD	O	VD output
12	FLD	O	Field identifier signal High: odd Low: even Must be tied high if SSGSCAN is high.
13	V _{DD}		
14	KISYU	I	Must be tied high when used with the LC9949G. Otherwise must be tied low.
15	HR	I	Horizontal reset, C.SYNC reset, and vertical reset pulse input
16	VR	I	Vertical reset pulse input and external synchronization mode setup
17	GND		
18	SELMET1	I	Light metering mode control
19	SELMET2	I	Light metering mode control
20	EXT1	I	External synchronization mode control
21	EXT2	I	External synchronization mode control
22	EXT3	I	CCD drive external control mode control
23	EXT4	I	CCD drive external control mode control
24	V _{DD}	I	
25	STEPSTOP	I/O	Normally used to control the electronic iris step (rate of change) Low: 1/8 High: 1/16
26	SENS	I	Sensitivity increasing switch Low/open: normal High: Increased sensitivity mode
27	MSENS	I	Increased sensitivity mode type switching Low or open: In field units High: In single scan line (1H) units
28	FLESS	I	Flickerless mode* switch Low: Flickerless mode High/open: normal
29	STR	I	CCD storage mode control This pin must be left open or tied high when the LC99012A-S is used with an LC9947G/49G, and must be tied low when used with an LC9948G.
30	NSUB3	O	CCD NSUB pulses
31	NSUB2	O	CCD NSUB pulses
32	NSUB1	O	CCD NSUB pulses
33	TEST	I	Low: test mode High/open: normal operating mode
34	VI1	O	CCD imaging block transfer clock (ø1)
35	VI3	O	CCD imaging block transfer clock (ø3)
36	VI2	O	CCD imaging block transfer clock (ø2)
37	VI4	O	CCD imaging block transfer clock (ø4)
38	VS4	O	CCD imaging block transfer clock (øS4)

Note: * Flickerless mode can be used when the auto-iris function is off, i.e. when EXT3 is high and EXT4 is low.

Continued on next page.

LC99012A-S

Pin No.	Symbol	I/O	Function
39	VS1	O	CCD imaging block transfer clock ($\phi S1$)
40	VS2	O	CCD imaging block transfer clock ($\phi S2$)
41	VS3	O	CCD imaging block transfer clock ($\phi S3$)
42	GND		
43	DHTR		CCD output block reset pulse
44	DHT1	O	CCD horizontal transfer clock ($\phi H1$)
45	DHT2	O	CCD horizontal transfer clock ($\phi H2$)
46	V _{DD}		
47	DS2	O	CCD output floating level sampling pulse
48	DS1	O	CCD output video signal sampling pulse
49	GND		
50	CLP1	O	OPB clamp pulse 
51	CLP2	O	OPB clamp pulse 
52	PBLK	O	Pre-blanking pulse 
53	CBLK	O	Composite blanking pulse 
54	C.SYNC	O	Composite sync pulse 
55	TV	I	Low: EIA (LC9947G/49G) High: CCIR (LC9948G)
56	V _{DD}		
57	AGCC2	O	AGC detection signal weighting processing pulse
58	IRSTA	O	Electronic iris state output High: The iris is in the fully stopped down state. Low: The iris is in the fully open state. High-impedance: The iris is in an appropriate state.
59	VIDI	I	Analog switch input for iris detection signal window processing
60	VIDO	O	Analog switch output for iris detection signal window processing
61	IRRES	O	Reset (discharge) pulse that is input by the iris signal detection (integration) circuit
62	IRIS	I	Iris integration signal input
63	DCH	I	High-level reference voltage for the iris level detection comparator
64	DCL	I	Low-level reference voltage for the iris level detection comparator

- No products described or contained herein are intended for use in surgical implants, life-support systems, aerospace equipment, nuclear power control systems, vehicles, disaster/crime-prevention equipment and the like, the failure of which may directly or indirectly cause injury, death or property loss.
- Anyone purchasing any products described or contained herein for an above-mentioned use shall:
 - ① Accept full responsibility and indemnify and defend SANYO ELECTRIC CO., LTD., its affiliates, subsidiaries and distributors and all their officers and employees, jointly and severally, against any and all claims and litigation and all damages, cost and expenses associated with such use:
 - ② Not impose any responsibility for any fault or negligence which may be cited in any such claim or litigation on SANYO ELECTRIC CO., LTD., its affiliates, subsidiaries and distributors or any of their officers and employees jointly or severally.
- Information (including circuit diagrams and circuit parameters) herein is for example only; it is not guaranteed for volume production. SANYO believes information herein is accurate and reliable, but no guarantees are made or implied regarding its use or any infringements of intellectual property rights or other rights of third parties.

This catalog provides information as of February, 1997. Specifications and information herein are subject to change without notice.