



**N-channel logic level TrenchMOS™ transistor PSMN005-55B, PSMN005-55P**

**FEATURES**

- 'Trench' technology
- Very low on-state resistance
- Fast switching
- Low thermal resistance

**SYMBOL**

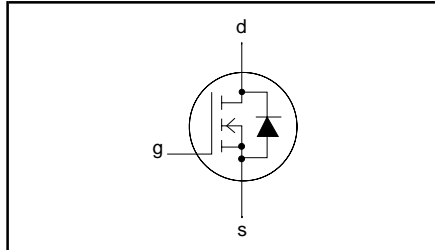

**QUICK REFERENCE DATA**

$V_{DSS} = 55\text{ V}$
$I_D = 75\text{ A}$
$R_{DS(ON)} \leq 5.8\text{ m}\Omega (V_{GS} = 10\text{ V})$
$R_{DS(ON)} \leq 6.3\text{ m}\Omega (V_{GS} = 5\text{ V})$

**GENERAL DESCRIPTION**

SiliconMAX products use the latest Philips Trench technology to achieve the lowest possible on-state resistance in each package at each voltage rating.

**Applications:-**

- d.c. to d.c. converters
- switched mode power supplies

The PSMN005-55P is supplied in the SOT78 (TO220AB) conventional leaded package.

The PSMN005-55B is supplied in the SOT404 surface mounting package.

**PINNING**

PIN	DESCRIPTION
1	gate
2	drain <sup>1</sup>
3	source
tab	drain

**SOT78 (TO220AB)**

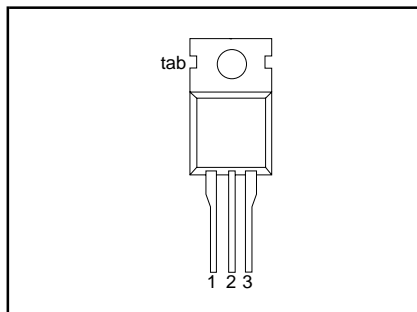

**SOT404 (D<sup>2</sup>PAK)**

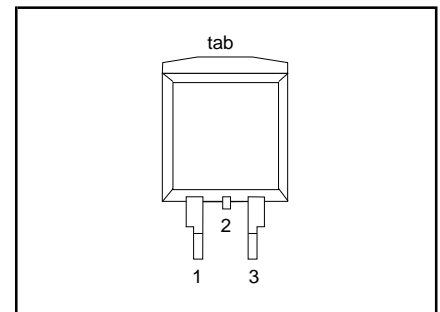

**LIMITING VALUES**

Limiting values in accordance with the Absolute Maximum System (IEC 134)

SYMBOL	PARAMETER	CONDITIONS	MIN.	MAX.	UNIT
$V_{DSS}$	Drain-source voltage	$T_j = 25\text{ }^\circ\text{C}$ to $175\text{ }^\circ\text{C}$	-	55	V
$V_{DGR}$	Drain-gate voltage	$T_j = 25\text{ }^\circ\text{C}$ to $175\text{ }^\circ\text{C}$ ; $R_{GS} = 20\text{ k}\Omega$	-	55	V
$V_{GS}$	Continuous gate-source voltage		-	$\pm 15$	V
$V_{GSM}$	Peak pulsed gate-source voltage	$T_j \leq 150\text{ }^\circ\text{C}$	-	$\pm 20$	V
$I_D$	Continuous drain current	$T_{mb} = 25\text{ }^\circ\text{C}$ ; $V_{GS} = 5\text{ V}$	-	$75^2$	A
		$T_{mb} = 100\text{ }^\circ\text{C}$ ; $V_{GS} = 5\text{ V}$	-	$75^2$	A
$I_{DM}$	Pulsed drain current	$T_{mb} = 25\text{ }^\circ\text{C}$	-	240	A
$P_D$	Total power dissipation	$T_{mb} = 25\text{ }^\circ\text{C}$	-	230	W
$T_j, T_{stg}$	Operating junction and storage temperature		- 55	175	$^\circ\text{C}$

<sup>1</sup> It is not possible to make connection to pin:2 of the SOT404 package

<sup>2</sup> maximum current limited by package

**SiliconMAX**

N-channel logic level TrenchMOS™ transistor

PSMN005-55B, PSMN005-55P

**THERMAL RESISTANCES**

SYMBOL	PARAMETER	CONDITIONS	TYP.	MAX.	UNIT
$R_{th\ j-mb}$	Thermal resistance junction to mounting base		-	0.65	K/W
$R_{th\ j-a}$	Thermal resistance junction to ambient	SOT78 package, in free air	60	-	K/W
		SOT404 package, pcb mounted, minimum footprint	50	-	K/W

**AVALANCHE ENERGY LIMITING VALUES**

Limiting values in accordance with the Absolute Maximum System (IEC 134)

SYMBOL	PARAMETER	CONDITIONS	MIN.	MAX.	UNIT
$E_{AS}$	Non-repetitive avalanche energy	Unclamped inductive load, $I_{AS} = 75\text{ A}$ ; $t_p = 100\ \mu\text{s}$ ; $T_j$ prior to avalanche = $25^\circ\text{C}$ ; $V_{DD} \leq 15\text{ V}$ ; $R_{GS} = 50\ \Omega$ ; $V_{GS} = 5\text{ V}$	-	268	mJ
$I_{AS}$	Non-repetitive avalanche current		-	75	A

**ELECTRICAL CHARACTERISTICS** $T_j = 25^\circ\text{C}$  unless otherwise specified

SYMBOL	PARAMETER	CONDITIONS	MIN.	TYP.	MAX.	UNIT
$V_{(BR)DSS}$	Drain-source breakdown voltage	$V_{GS} = 0\text{ V}$ ; $I_D = 0.25\text{ mA}$ ; $T_j = -55^\circ\text{C}$	55	-	-	V
$V_{GS(TO)}$	Gate threshold voltage	$V_{DS} = V_{GS}$ ; $I_D = 1\text{ mA}$ ; $T_j = 175^\circ\text{C}$	1.0	1.5	2.0	V
		$T_j = -55^\circ\text{C}$	0.5	-	-	V
			-	-	2.3	V
$R_{DS(ON)}$	Drain-source on-state resistance	$V_{GS} = 10\text{ V}$ ; $I_D = 25\text{ A}$	-	4.8	5.8	m $\Omega$
		$V_{GS} = 5\text{ V}$ ; $I_D = 25\text{ A}$	-	5.3	6.3	m $\Omega$
		$V_{GS} = 4.5\text{ V}$ ; $I_D = 25\text{ A}$	-	-	6.7	m $\Omega$
		$V_{GS} = 5\text{ V}$ ; $I_D = 25\text{ A}$ ; $T_j = 175^\circ\text{C}$	-	-	13.2	m $\Omega$
$I_{GSS}$	Gate source leakage current	$V_{GS} = \pm 10\text{ V}$ ; $V_{DS} = 0\text{ V}$	-	2	100	nA
$I_{DSS}$	Zero gate voltage drain current	$V_{DS} = 55\text{ V}$ ; $V_{GS} = 0\text{ V}$ ; $T_j = 175^\circ\text{C}$	-	0.05	10	$\mu\text{A}$
			-	-	500	$\mu\text{A}$
$Q_{g(tot)}$	Total gate charge	$I_D = 75\text{ A}$ ; $V_{DD} = 44\text{ V}$ ; $V_{GS} = 5\text{ V}$	-	103	-	nC
$Q_{gs}$	Gate-source charge		-	15	-	nC
$Q_{gd}$	Gate-drain (Miller) charge		-	52	-	nC
$t_{d\ on}$	Turn-on delay time	$V_{DD} = 30\text{ V}$ ; $R_D = 1.2\ \Omega$ ;	-	45	-	ns
$t_r$	Turn-on rise time	$V_{GS} = 5\text{ V}$ ; $R_G = 10\ \Omega$	-	180	-	ns
$t_{d\ off}$	Turn-off delay time	Resistive load	-	420	-	ns
$t_f$	Turn-off fall time		-	235	-	ns
$L_d$	Internal drain inductance	Measured from tab to centre of die	-	3.5	-	nH
$L_d$	Internal drain inductance	Measured from drain lead to centre of die (SOT78 package only)	-	4.5	-	nH
$L_s$	Internal source inductance	Measured from source lead to source bond pad	-	7.5	-	nH
$C_{iss}$	Input capacitance	$V_{GS} = 0\text{ V}$ ; $V_{DS} = 25\text{ V}$ ; $f = 1\text{ MHz}$	-	6500	-	pF
$C_{oss}$	Output capacitance		-	1500	-	pF
$C_{rss}$	Feedback capacitance		-	700	-	pF

**SiliconMAX**

N-channel logic level TrenchMOS™ transistor PSMN005-55B, PSMN005-55P

**REVERSE DIODE LIMITING VALUES AND CHARACTERISTICS** $T_j = 25^\circ\text{C}$  unless otherwise specified

SYMBOL	PARAMETER	CONDITIONS	MIN.	TYP.	MAX.	UNIT
$I_S$	Continuous source current (body diode)		-	-	75	A
$I_{SM}$	Pulsed source current (body diode)		-	-	240	A
$V_{SD}$	Diode forward voltage	$I_F = 25\text{ A}; V_{GS} = 0\text{ V}$	-	0.85	1.2	V
		$I_F = 75\text{ A}; V_{GS} = 0\text{ V}$	-	1.1	-	V
$t_{rr}$	Reverse recovery time	$I_F = 20\text{ A}; -dI_F/dt = 100\text{ A}/\mu\text{s};$	-	80	-	ns
$Q_{rr}$	Reverse recovery charge	$V_{GS} = 0\text{ V}; V_R = 30\text{ V}$	-	0.2	-	$\mu\text{C}$

**SiliconMAX**

N-channel logic level TrenchMOS™ transistor

PSMN005-55B, PSMN005-55P

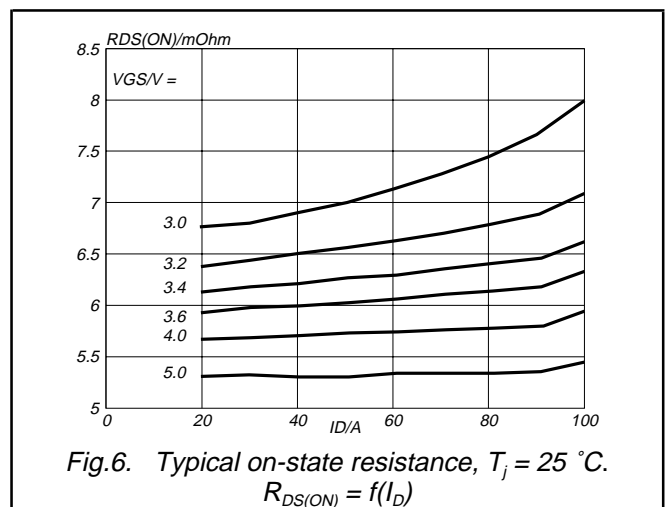
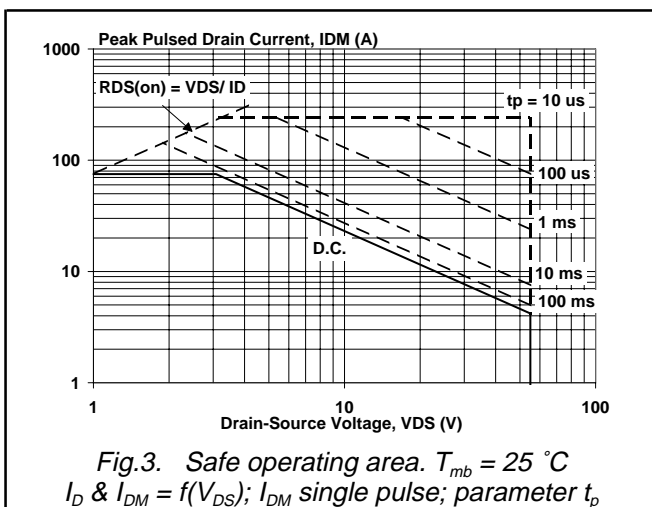
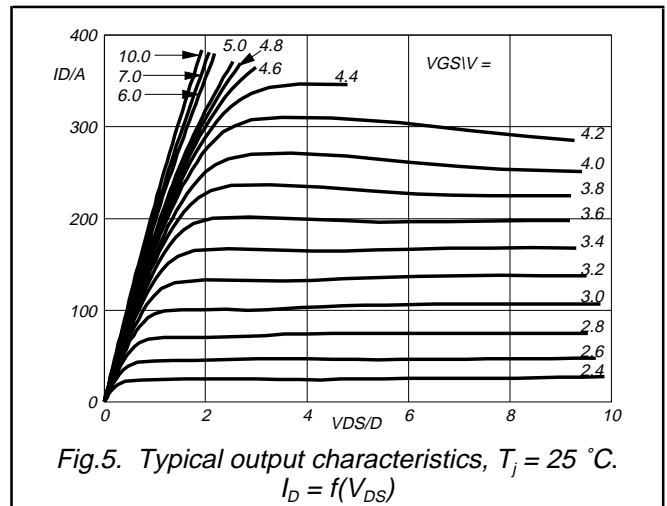
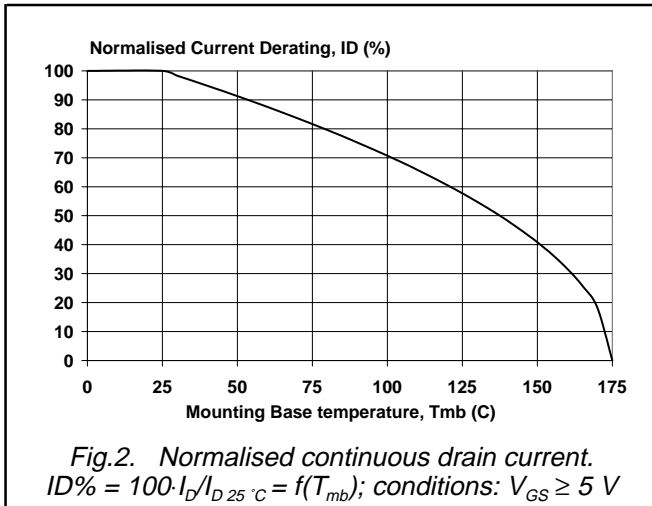
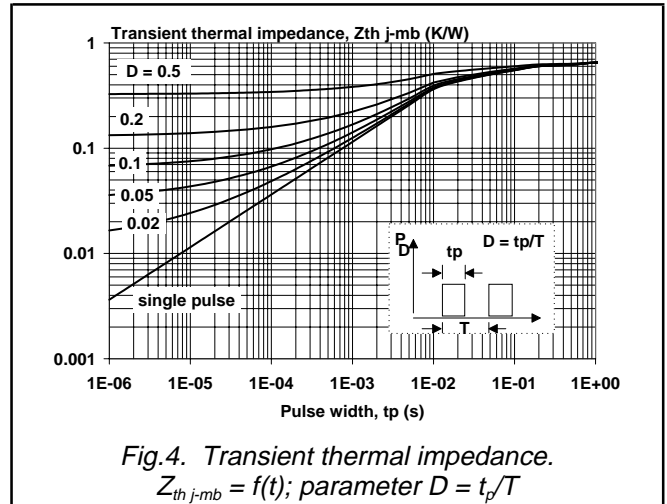
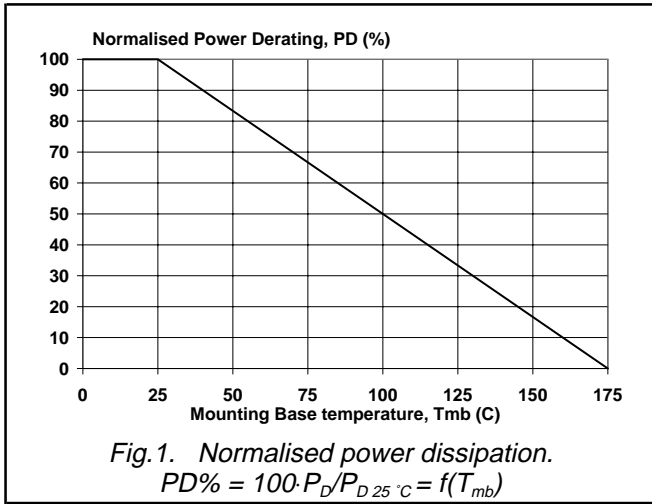

**SiliconMAX**

N-channel logic level TrenchMOS™ transistor

PSMN005-55B, PSMN005-55P

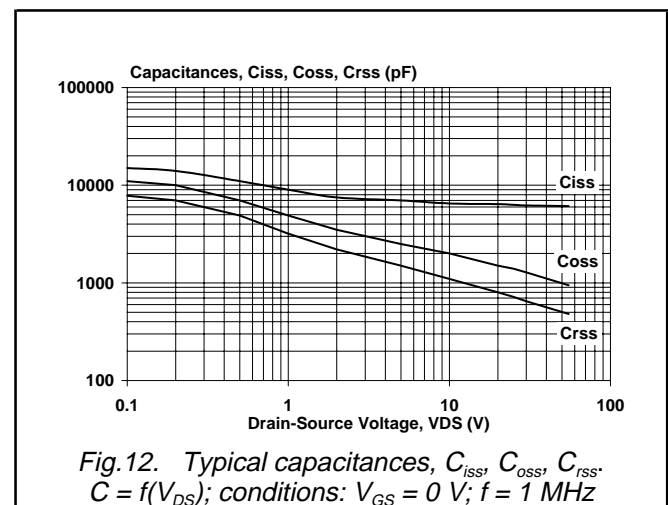
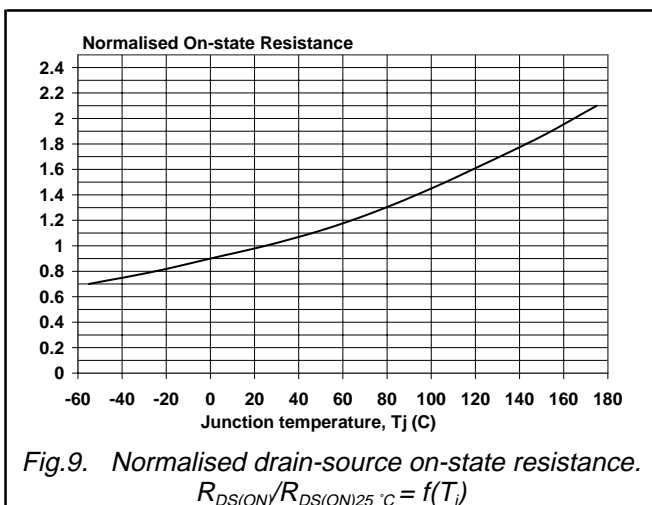
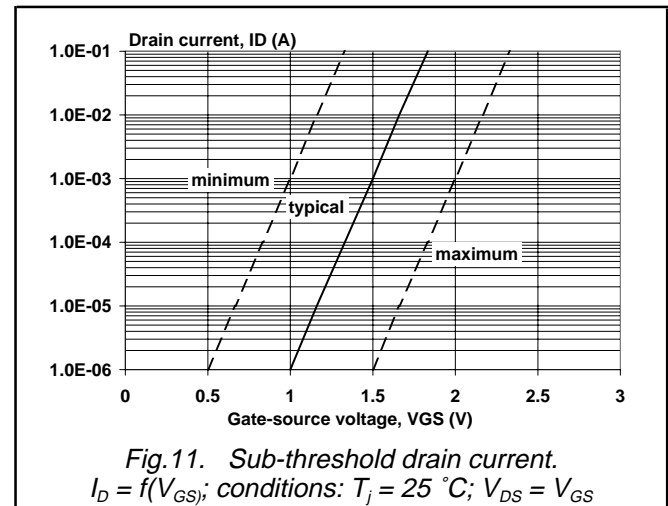
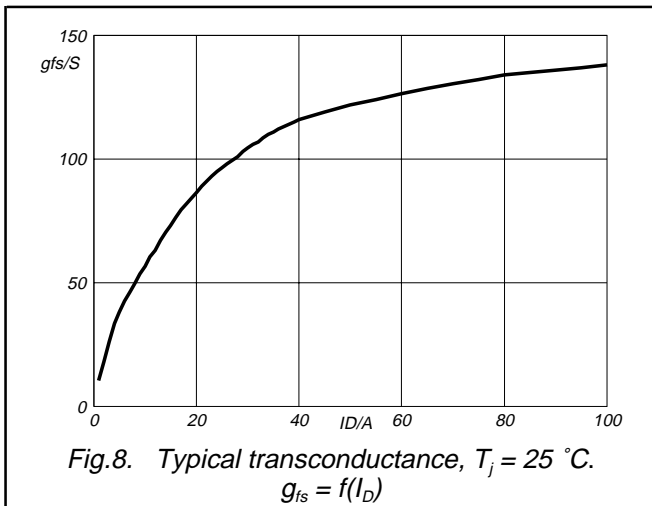
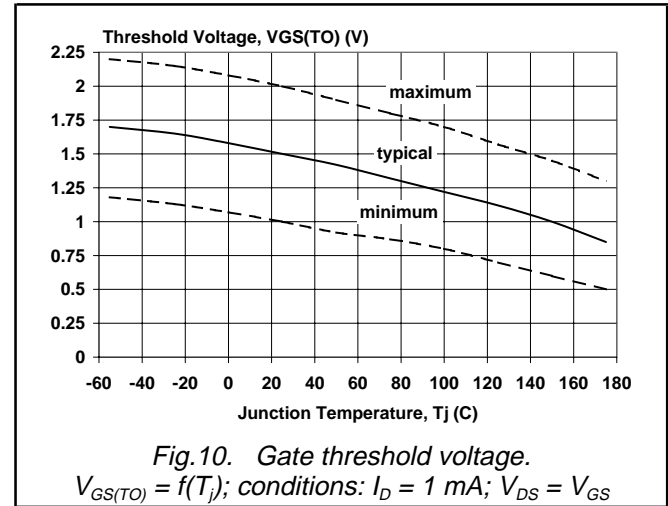
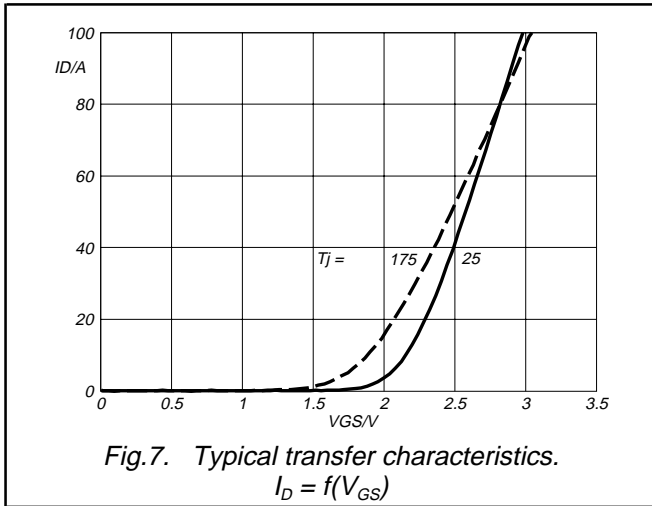

**SiliconMAX**

N-channel logic level TrenchMOS™ transistor

PSMN005-55B, PSMN005-55P

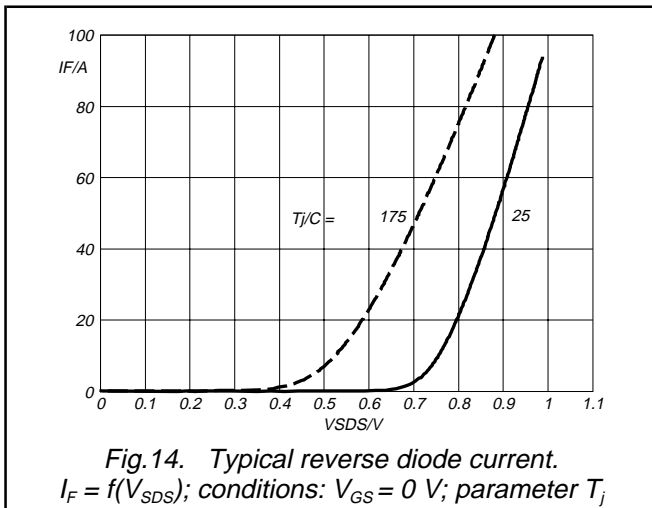
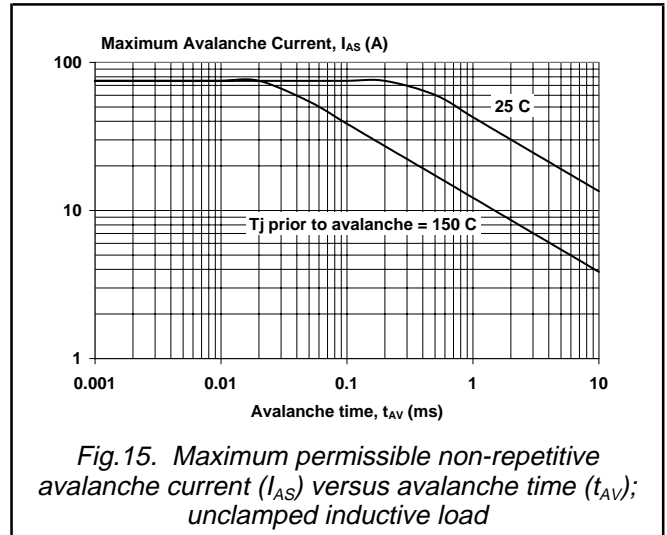
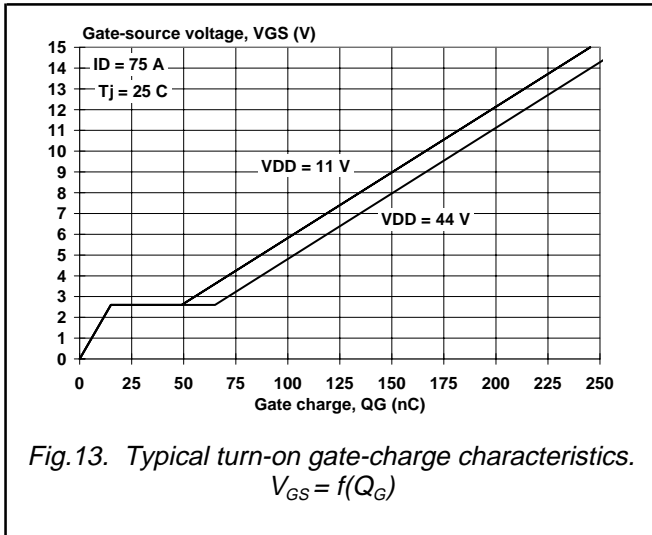



N-channel logic level TrenchMOS™ transistor

PSMN005-55B, PSMN005-55P

**MECHANICAL DATA**

Plastic single-ended package; heatsink mounted; 1 mounting hole; 3-lead TO-220 SOT78

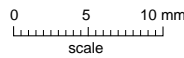
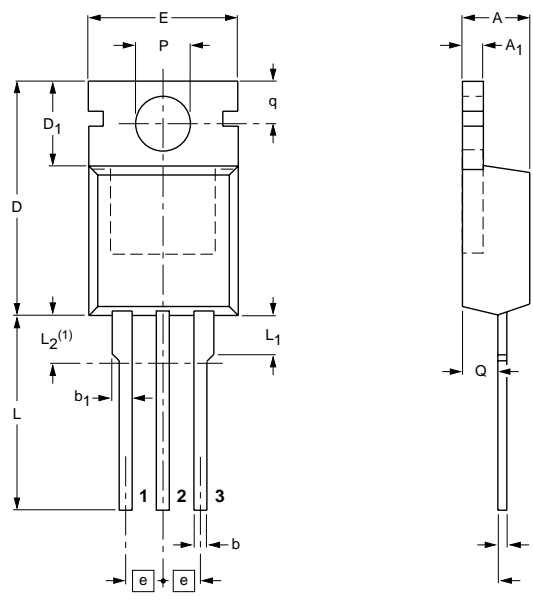

DIMENSIONS (mm are the original dimensions)

UNIT	A	A <sub>1</sub>	b	b <sub>1</sub>	c	D	D <sub>1</sub>	E	e	L	L <sub>1</sub>	L <sub>2</sub> <sup>(1)</sup> max.	P	q	Q
mm	4.5	1.39	0.9	1.3	0.7	15.8	6.4	10.3	2.54	15.0	3.30	3.0	3.8	3.0	2.6
	4.1	1.27	0.7	1.0	0.4	15.2	5.9	9.7		13.5	2.79		3.6	2.7	2.2

**Note**

1. Terminals in this zone are not tinned.

OUTLINE VERSION	REFERENCES				EUROPEAN PROJECTION	ISSUE DATE
	IEC	JEDEC	EIAJ			
SOT78		TO-220				97-06-11

Fig.16. SOT78 (TO220AB); pin 2 connected to mounting base (Net mass:2g)

**Notes**

1. This product is supplied in anti-static packaging. The gate-source input must be protected against static discharge during transport or handling.
2. Refer to mounting instructions for SOT78 (TO220AB) package.
3. Epoxy meets UL94 V0 at 1/8".



N-channel logic level TrenchMOS™ transistor

PSMN005-55B, PSMN005-55P

**MECHANICAL DATA**

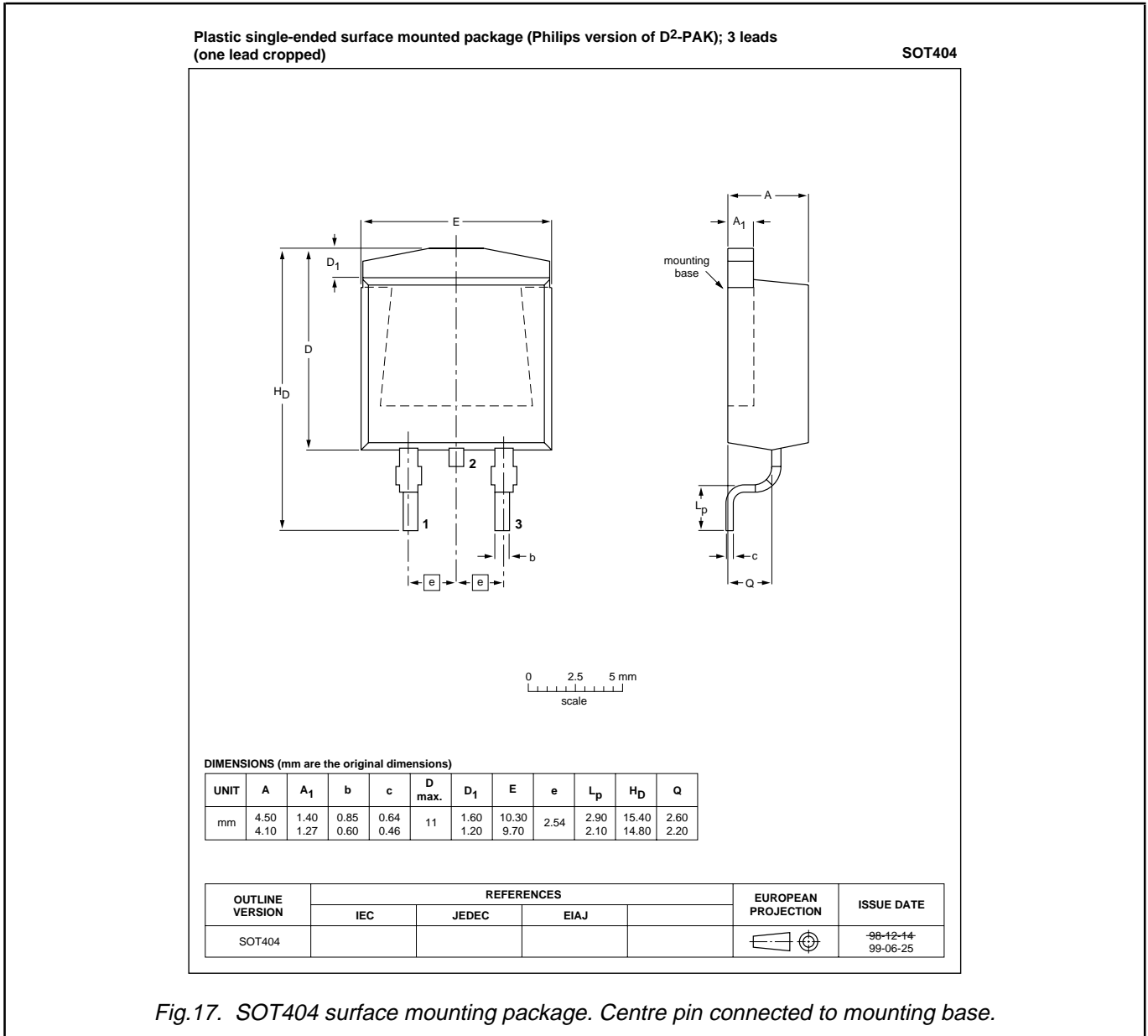

**Notes**

1. This product is supplied in anti-static packaging. The gate-source input must be protected against static discharge during transport or handling.
2. Refer to SMD Footprint Design and Soldering Guidelines, Data Handbook SC18.
3. Epoxy meets UL94 V0 at 1/8".



**SiliconMAX**

N-channel logic level TrenchMOS™ transistor

PSMN005-55B, PSMN005-55P

**MOUNTING INSTRUCTIONS**

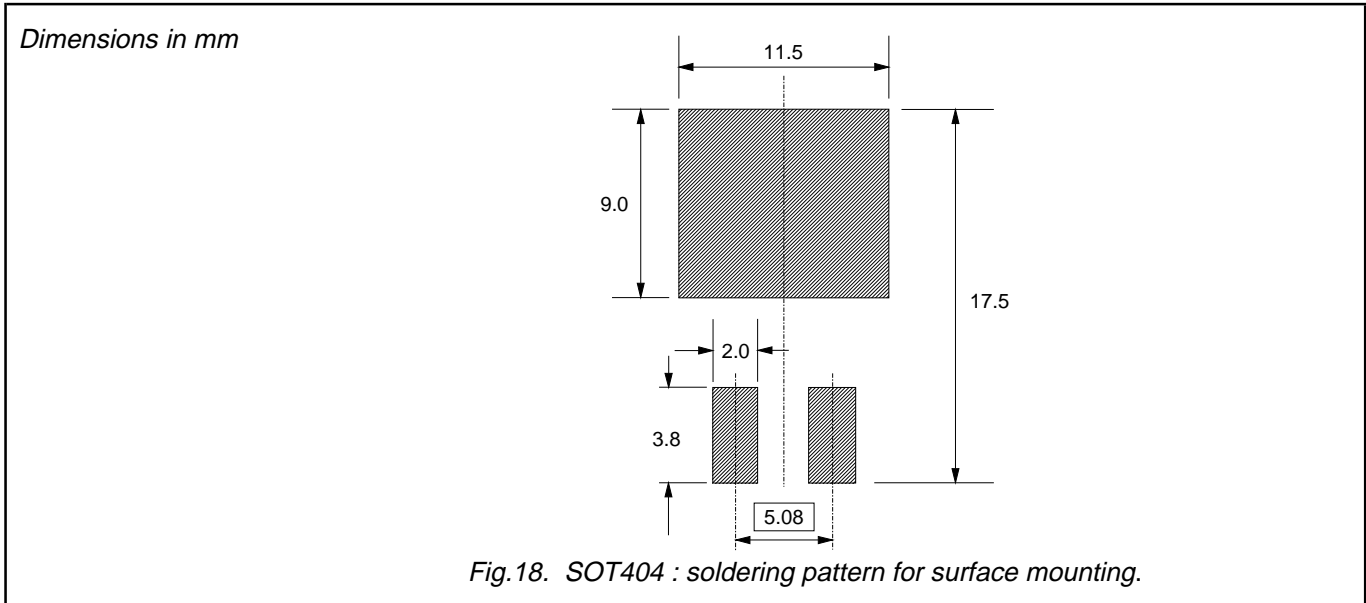

**DEFINITIONS**

<b>Data sheet status</b>	
Objective specification	This data sheet contains target or goal specifications for product development.
Preliminary specification	This data sheet contains preliminary data; supplementary data may be published later.
Product specification	This data sheet contains final product specifications.
<b>Limiting values</b>	
Limiting values are given in accordance with the Absolute Maximum Rating System (IEC 134). Stress above one or more of the limiting values may cause permanent damage to the device. These are stress ratings only and operation of the device at these or at any other conditions above those given in the Characteristics sections of this specification is not implied. Exposure to limiting values for extended periods may affect device reliability.	
<b>Application information</b>	
Where application information is given, it is advisory and does not form part of the specification.	
© Philips Electronics N.V. 1999	
All rights are reserved. Reproduction in whole or in part is prohibited without the prior written consent of the copyright owner.	
The information presented in this document does not form part of any quotation or contract, it is believed to be accurate and reliable and may be changed without notice. No liability will be accepted by the publisher for any consequence of its use. Publication thereof does not convey nor imply any license under patent or other industrial or intellectual property rights.	

**LIFE SUPPORT APPLICATIONS**

These products are not designed for use in life support appliances, devices or systems where malfunction of these products can be reasonably expected to result in personal injury. Philips customers using or selling these products for use in such applications do so at their own risk and agree to fully indemnify Philips for any damages resulting from such improper use or sale.