

UG18ACT THRU UG18DCT

ULTRAFAST EFFICIENT PLASTIC RECTIFIER

Reverse Voltage - 50 to 200 Volts

Forward Current - 18.0 Amperes

TO-220AB

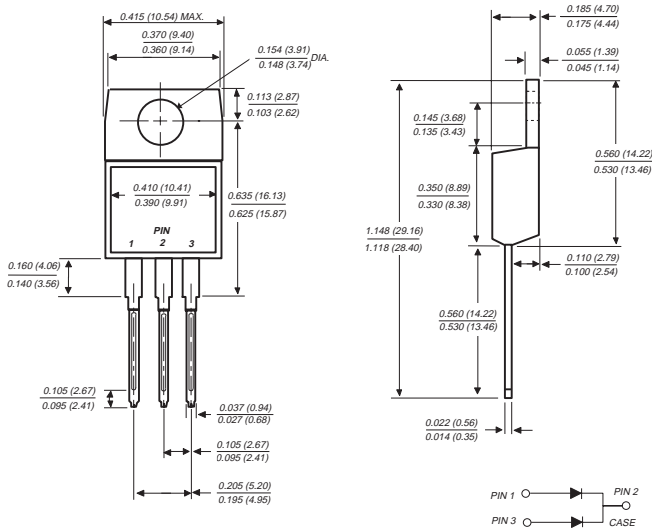

Dimensions in inches and (millimeters)

FEATURES

- ◆ Plastic package has Underwriters Laboratories Flammability Classification 94V-0
- ◆ Ideally suited for use in very high frequency switching power supplies, inverters and as a free wheeling diode
- ◆ Ultrafast 25 nanosecond reverse recovery times
- ◆ Soft recovery characteristics
- ◆ Excellent high temperature switching
- ◆ Glass passivated junctions
- ◆ High temperature soldering guaranteed: 250°C, 0.16" (4.06mm) case for 10 seconds

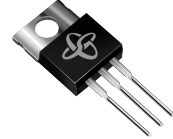

MECHANICAL DATA

Case: JEDEC TO-220AB molded plastic body over passivated chips

Terminals: Plated leads solderable per MIL-STD-750, Method 2026

Polarity: As marked

Mounting Position: Any

Mounting Torque: 5 in. - lbs. max.

Weight: 0.08 ounce, 2.24 grams

MAXIMUM RATINGS AND ELECTRICAL CHARACTERISTICS

Ratings at 25°C ambient temperature unless otherwise specified.

	SYMBOLS	UG18ACT	UG18BCT	UG18CCT	UG18DCT	UNITS
Maximum repetitive peak reverse voltage	V_{RRM}	50	100	150	200	Volts
Maximum RMS voltage	V_{RMS}	35	70	105	140	Volts
Maximum DC blocking voltage	V_{DC}	50	100	150	200	Volts
Maximum average forward rectified current at $T_C=105^\circ\text{C}$	$I_{(AV)}$	18.0				Amps
Peak forward surge current 8.3ms single half sine-wave superimposed on rated load (JEDEC Method) per leg at $T_C=105^\circ\text{C}$	I_{FSM}	175.0				Amps
Maximum instantaneous forward voltage per leg at 9.0A 20A 5.0A, $T_J=100^\circ\text{C}$	V_F	1.10 1.20 0.95				Volts
Maximum DC reverse current at rated DC blocking voltage per leg $T_A=25^\circ\text{C}$ $T_A=100^\circ\text{C}$	I_R	10.0 300.0				μA
Maximum reverse recovery time per leg (NOTE 1)	t_{rr}	20.0				ns
Maximum reverse recovery time per leg $T_J=25^\circ\text{C}$ (NOTE 2) $T_J=100^\circ\text{C}$	t_{rr}	30.0 50.0				ns
Maximum recovered stored charge per leg $T_J=25^\circ\text{C}$ (NOTE 2) $T_J=100^\circ\text{C}$	Q_{rr}	20.0 45.0				nC
Typical junction capacitance per leg (NOTE 3)	C_J	30.0				pF
Typical thermal resistance per leg (NOTE 4)	$R_{\theta JC}$	4.0				$^\circ\text{C}/\text{W}$
Operating junction and storage temperature range	T_J, T_{STG}	-65 to +150				$^\circ\text{C}$

NOTES: (1) Reverse recovery test conditions: $I_F=0.5\text{A}$, $I_R=1.0\text{A}$, $I_{rr}=0.25\text{A}$

(2) t_{rr} and Q_{rr} measured at: $I_F=9.0\text{A}$, $V_R=30\text{V}$, $di/dt=50\text{A}/\mu\text{s}$, $I_{rr}=10\% I_{RM}$

(3) Measured at 1.0 MHz and applied reverse voltage of 4.0 Volts

(4) Thermal resistance from junction to case per leg

RATINGS AND CHARACTERISTIC CURVES UG18ACT THRU UG18DCT

FIG. 1 - FORWARD CURRENT DERATING CURVE

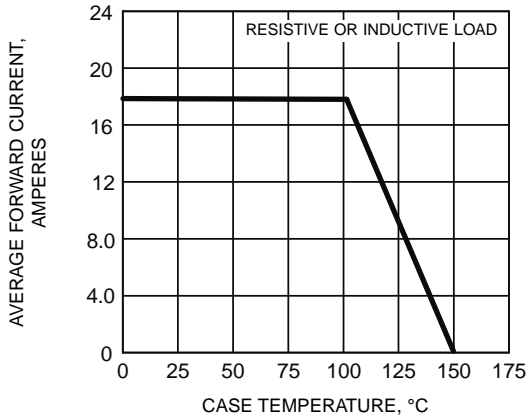

FIG. 2 - MAXIMUM NON-REPETITIVE PEAK FORWARD SURGE CURRENT PER LEG

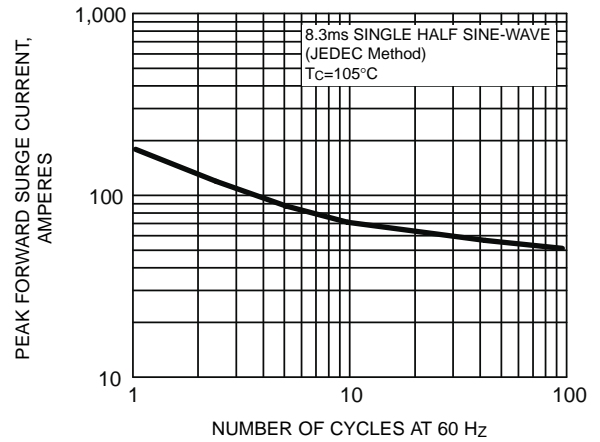

FIG. 3 - TYPICAL INSTANTANEOUS FORWARD CHARACTERISTICS PER LEG

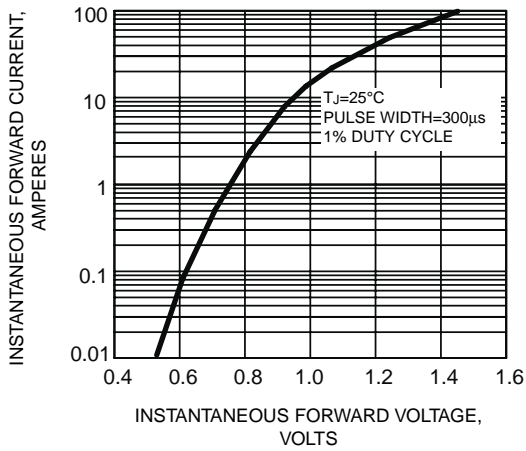

FIG. 4 - TYPICAL REVERSE CHARACTERISTICS PER LEG

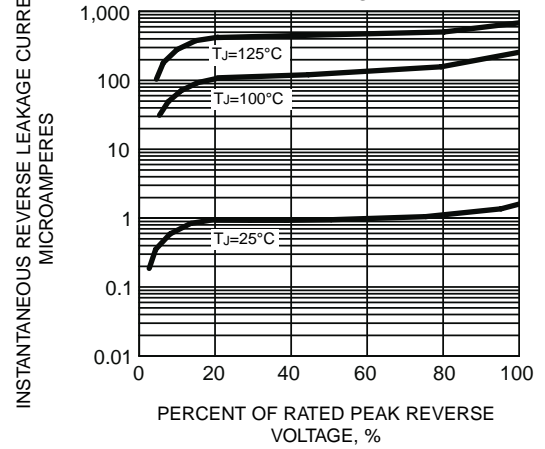

FIG. 5 - REVERSE SWITCHING CHARACTERISTICS PER LEG

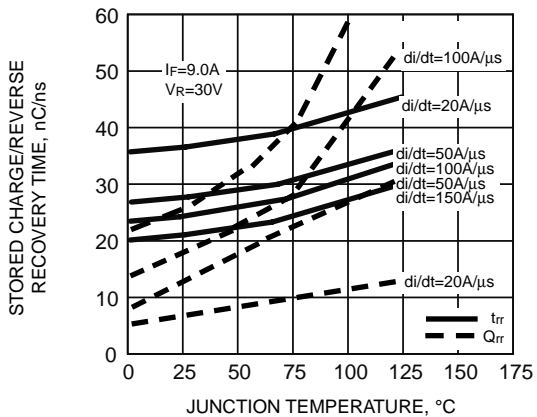

FIG. 6 - TYPICAL JUNCTION CAPACITANCE PER LEG

