

UP CONVERTER + QUADRATURE MODULATOR IC FOR DIGITAL MOBILE COMMUNICATION SYSTEMS

DESCRIPTION

The μ PC8104GR is a silicon monolithic integrated circuit designed as quadrature modulator for digital mobile communication systems. This modulator consists of 1.9 GHz up-converter and 400 MHz quadrature modulator which are packaged in 20 pin SSOP. The device has power save function and can operate 2.7 to 5.5 V supply voltage, therefore, it can contribute to make RF block small, high performance and low power consumption.

FEATURES

- 20 pin SSOP suitable for high density surface mounting.
- High linearity up converter is incorporated; $P_{RFout(sat)} = -6$ dBm TYP.
- Low phase difference due to digital phase shifter is adopted.
- Wide operating frequency range. Up converter; $f_{RFout} = 800$ MHz to 1.9 GHz
Modulator ; $f_{MODout} = 100$ MHz to 400 MHz, $f_{I/Q} = DC$ to 10 MHz
- External IF filter can be applied between modulator output and up converter input terminal.
- Supply voltage: $V_{CC} = 2.7$ to 5.5 V
- Equipped with power save function.

APPLICATION

- Digital cordless phones
- Digital cellular phones

ORDERING INFORMATION

PART NUMBER	PACKAGE	SUPPLYING FORM
μ PC8104GR-E1	20 pin plastic SSOP	Embossed tape 12 mm wide. QTY 2.5 kp/Reel. Pin 1 indicates pull-out direction of tape.

* For evaluation sample order, please contact your local NEC sales office. (Order number: μ PC8104GR)

Caution electro-static sensitive device

The information in this document is subject to change without notice. Before using this document, please confirm that this is the latest version.
Not all devices/types available in every country. Please check with local NEC representative for availability and additional information.

INTERNAL BLOCK DIAGRAM AND PIN CONNECTIONS (Top View)

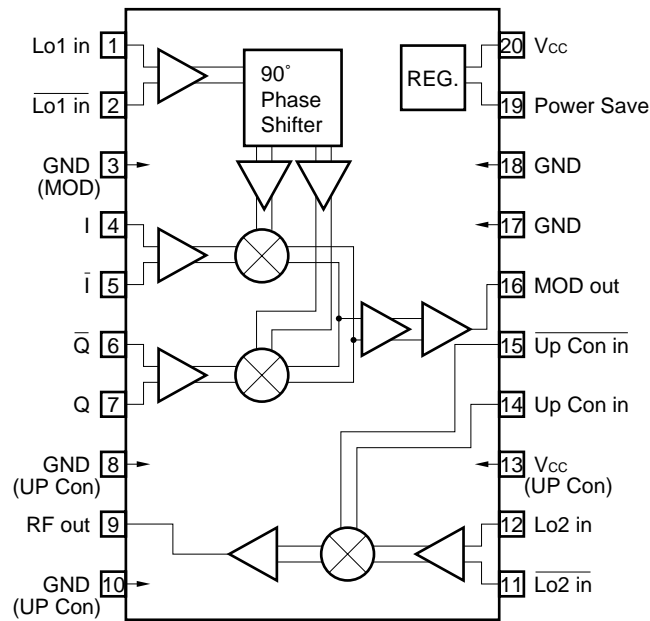

APPLICATION EXAMPLE

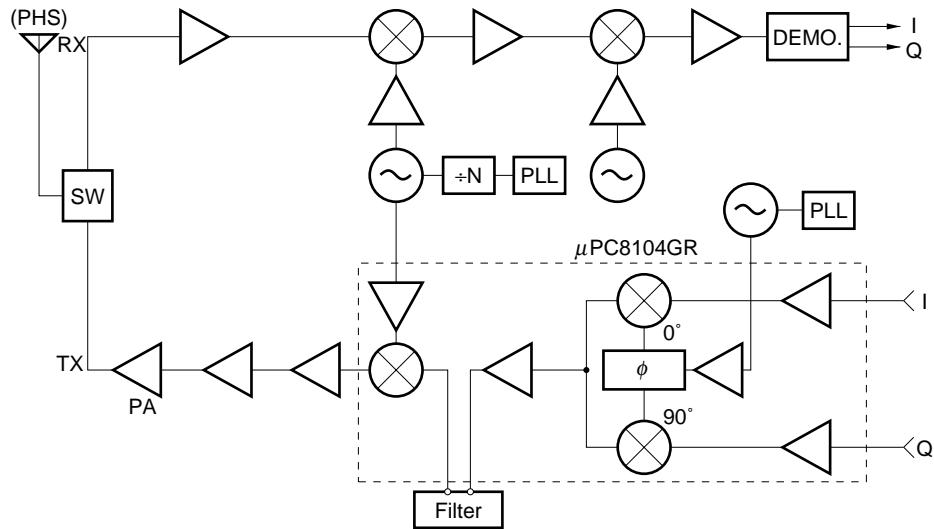

ABSOLUTE MAXIMUM RATINGS

PARAMETER	SYMBOL	RATING	UNIT	TEST CONDITION
Supply Voltage	V _{CC}	6.0	V	T _A = +25 °C
Power Save Voltage	V _{PS}	6.0	V	T _A = +25 °C
Power Dissipation	P _D	430	mW	T _A = +85 °C ^{Note1}
Operating Temperature	T _A	-40 to +85	°C	
Storage Temperature	T _{stg}	-55 to +150	°C	

Note 1: Mounted on 50 × 50 × 1.6 mm double copper clad epoxy glass board

RECOMMENDED OPERATING CONDITIONS

PARAMETER	SYMBOL	MIN.	TYP.	MAX.	UNIT	TEST CONDITIONS
Supply Voltage	V _{CC}	2.7	3.0	5.5	V	
Operating Temperature	T _A	-40	+25	+85	°C	
Up Converter RF Frequency	f _{RFout}	0.8		1.9	GHz	
Up Converter Input Freq.	f _{UpConin}	100		400	MHz	
Modulator Output Frequency	f _{MODout}					
Lo1 Input Frequency	f _{Lo1in}					P _{Lo1in} = -10 dBm
Lo2 Input Frequency	f _{Lo2in}	800		1800	MHz	P _{Lo2in} = -10 dBm
I/Q Input Frequency	f _{I/Qin}	DC		10	MHz	P _{I/Qin} = 600 mV _{p-p} MAX (Single ended)

ELECTRICAL CHARACTERISTICS (T_A = +25 °C, V_{CC} = 3.0 V, Unless Otherwise Specified V_{PS} ≥ 1.8 V)

PARAMETER	SYMBOL	MIN.	TYP.	MAX.	UNIT	TEST CONDITIONS
UP CONVERTER + QUADRATURE MODULATOR TOTAL						
Total Circuit Current	I _{ccTOTAL}	18	28	37	mA	No input signal
Total Circuit Current at Power-Save Mode	I _{cc(PS)TOTAL}		0.1	10	μA	V _{PS} ≤ 1.0 V
Total Output Power	P _{RFout}	-18.5	-13.5	-8.5	dBm	I/Q DC = 1.5 V P _{I/Qin} = 500 mV _{p-p} (Single ended)
Lo Carrier Leak ^{Note2}	LOL		-40	-30	dBc	
Image Rejection (Side Band Leak)	ImR		-40	-30	dBc	

Note 2: Lo1 + Lo2

STANDARD CHARACTERISTICS FOR REFERENCE

(T_A = +25 °C, V_{CC} = 3.0 V, Unless Otherwise Specified V_{PS} ≥ 1.8 V)

PARAMETER	SYMBOL	MIN.	TYP.	MAX.	UNIT	TEST CONDITIONS
UP CONVERTER BLOCK						
Up Con. Circuit Current	I _{ccUpCon}		12		mA	No input signal
Up Con. Circuit Current at Power-Save Mode	I _{cc(PS)UpCon}			5	μA	V _{PS} ≤ 1.0 V
Conversion Gain	CG		4		dB	f _{RFout} = 1.9 GHz
Maximum Output Power	P _{RF(sat)}		-6		dBm	f _{UpConin} = 240.0 MHz/240.2 MHz
Output Intercept Point	OIP3		0		dBm	
QUADRATURE MODULATOR BLOCK						
MOD. Circuit Current	I _{ccMOD}	10	16	21	mA	No input signal
MOD. Circuit Current at Power-Save Mode	I _{cc(PS)MOD}			5	μA	V _{PS} ≤ 1.0 V
Output Power	P _{MODout}		-16.5		dBm	I/Q DC = 1.5 V
Lo1 Carrier Leak	LOL		-40	-30	dBc	P _{I/Qin} = 500 mV _{p-p} (Single ended)
Image Rejection (Side Band Leak)	ImR		-40	-30	dBc	
I/Q 3rd Order Intermodulation Distortion	Im _{3I/Q}		-50	-30	dBc	
I/Q Input Impedance	Z _{I/Q}		20		kΩ	I/Q DC = 1.5 V
I/Q Bias Current	I _{I/Q}		5		μA	P _{I/Qin} = 500 mV _{p-p} (Single ended) (I → I, Q → Q)
Lo1 Input VSWR	Z _{Lo1}		1.2:1		X:1	
Power Save Rise Time	T _{PS(RISE)}		2.0	5.0	μs	V _{PS(OFF)} → V _{PS(ON)}
Power Save Fall Time	T _{PS(FALL)}		2.0	5.0	μs	V _{PS(ON)} → V _{PS(OFF)}

PIN EXPLANATION

PIN NO.	ASSIGNMENT	SUPPLY VOL. (V)	PIN VOL.(V)	FUNCTION AND APPLICATION	EQUIPMENT CIRCUIT												
1	Lo1in	-	0	Lo1 input for phase shifter. This input impedance is 50 Ω matched internally.													
2	$\overline{\text{Lo1in}}$	-	2.4	Bypass of Lo1 input. This pin is grounded through internal capacitor. Open in case of single ended.													
3	GND for modulator	0	-	Connect to the ground with minimum inductance. Track length should be kept as short as possible.													
4	I	$V_{cc}/2$	-	Input for I signal. This input impedance is larger than 20 kΩ. Relations between amplitude and $V_{cc}/2$ bias of input signal are following. <table border="1" style="margin-left: 20px;"> <thead> <tr> <th>$V_{cc}/2$ (v)</th> <th>Amp. (mV_{P-P})</th> <th>Note</th> </tr> </thead> <tbody> <tr> <td>≥ 1.35</td> <td>400</td> <td></td> </tr> <tr> <td>≥ 1.5</td> <td>600</td> <td></td> </tr> <tr> <td>≥ 1.75</td> <td>1000</td> <td></td> </tr> </tbody> </table>	$V_{cc}/2$ (v)	Amp. (mV _{P-P})	Note	≥ 1.35	400		≥ 1.5	600		≥ 1.75	1000		
$V_{cc}/2$ (v)	Amp. (mV _{P-P})	Note															
≥ 1.35	400																
≥ 1.5	600																
≥ 1.75	1000																
5	$\overline{\text{I}}$	$V_{cc}/2$	-	Input for I signal. This input impedance is larger than 20 kΩ. $V_{cc}/2$ biased DC signal should be input.													
6	$\overline{\text{Q}}$	$V_{cc}/2$	-	Input for Q signal. This input impedance is larger than 20 kΩ. $V_{cc}/2$ biased DC signal should be input.													
7	Q	$V_{cc}/2$	-	Input for Q signal. This input impedance is larger than 20 kΩ. Relations between amplitude and $V_{cc}/2$ bias of input signal are following. <table border="1" style="margin-left: 20px;"> <thead> <tr> <th>$V_{cc}/2$ (v)</th> <th>Amp. (mV_{P-P})</th> <th>Note</th> </tr> </thead> <tbody> <tr> <td>≥ 1.35</td> <td>400</td> <td></td> </tr> <tr> <td>≥ 1.5</td> <td>600</td> <td></td> </tr> <tr> <td>≥ 1.75</td> <td>1000</td> <td></td> </tr> </tbody> </table>		$V_{cc}/2$ (v)	Amp. (mV _{P-P})	Note	≥ 1.35	400		≥ 1.5	600		≥ 1.75	1000	
$V_{cc}/2$ (v)	Amp. (mV _{P-P})	Note															
≥ 1.35	400																
≥ 1.5	600																
≥ 1.75	1000																
16	MODout	-	1.5	Output from modulator. This is emitter follower output.													

Note In case of that I/Q input signals are single ended.
Of course, I/Q signal inputs can be used either single endedly or differentially with proper terminations.

PIN EXPLANATION

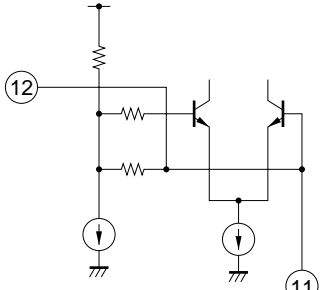
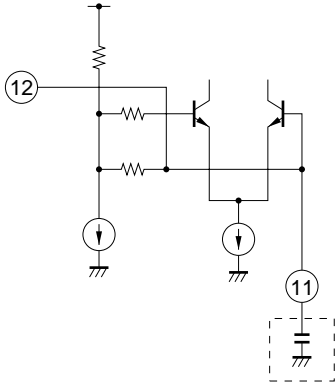
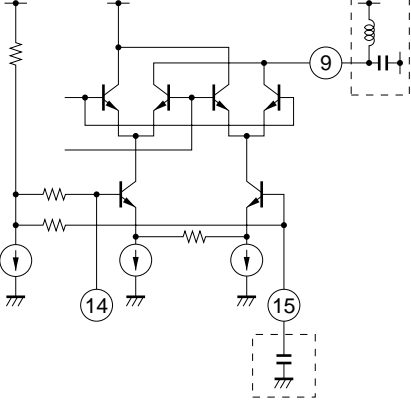
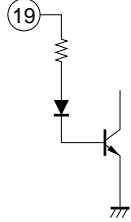
PIN NO.	ASSIGNMENT	SUPPLY VOL. (V)	PIN VOL.(V)	FUNCTION AND APPLICATION	EQUIPMENT CIRCUIT						
8	GND for Up-converter	0	-	Connect to the ground with minimum inductance. Track length should be kept as short as possible.							
10											
11	Lo2in	-	2.0	Bypass of Lo2 input. Grounded through external capacitor.							
12	Lo2in	-	0	Lo2 input of Up-converter. This pin is high impedance input.							
13	Vcc for Up-converter	2.7 to 5.5	-	Supply voltage pin for Up-converter.							
9	RFout	Vcc	-	RF output from Up-Converter. This pin is open collector output.							
14	UpConin	-	2.0	IF input for Up-converter. This pin is high impedance input.							
15	UpConin	-	2.0	Bypass of IF input. Grounded through external capacitor.							
17	GND	0	-	Connect to the ground with minimum inductance. Track length should be kept as short as possible.							
18											
19	Power Save	V _{PS}	-	Power save control pin can be controlled ON/SLEEP state with bias as follows; <table border="1" style="margin: 10px auto;"> <thead> <tr> <th>V_{PS} (V)</th> <th>STATE</th> </tr> </thead> <tbody> <tr> <td>1.8 to 5.5</td> <td>ON</td> </tr> <tr> <td>0 to 1.0</td> <td>SLEEP</td> </tr> </tbody> </table>	V _{PS} (V)	STATE	1.8 to 5.5	ON	0 to 1.0	SLEEP	
V _{PS} (V)	STATE										
1.8 to 5.5	ON										
0 to 1.0	SLEEP										
20	Vcc for Modulator	2.7 to 5.5	-	Supply voltage pin for modulator. Internal regulator can be kept stable condition of supply bias against the variable temperature or Vcc.							

: Externally

EXPLANATION OF INTERNAL FUNCTION

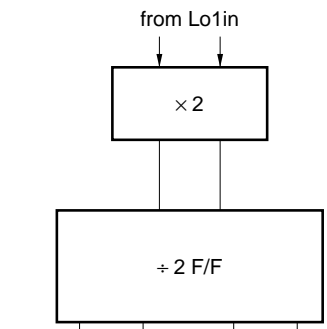
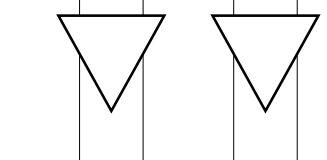
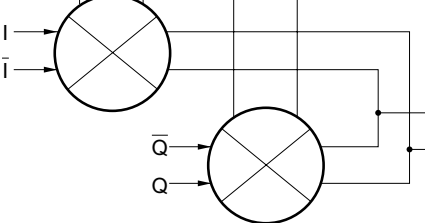
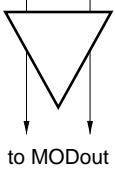
BLOCK	FUNCTION/OPERATION	BLOCK DIAGRAM
<p>90° PHASE SHIFTER</p>	<p>Input signal from Lo1 is send to digital circuit of T-type flip-flop through frequency doubler. Output signal from T-type F/F is changed to same frequency as Lo1 input and that have quadrature phase shift, 0°, 90°, 180°, 270°. These circuits have function of self phase correction to make correctly quadrature signals.</p>	
<p>BUFFER AMP.</p>	<p>Buffer amplifiers for each phase signals to send to each mixers.</p>	
<p>MIXER</p>	<p>Each signals from buffer amp. are quadrature modulated with two double-balanced mixers. High accurate phase and amplitude inputs are realized to good performance for image rejection.</p>	
<p>ADDER</p>	<p>Output signals from each mixers are added with adder and send to final amplifier.</p>	

TYPICAL CHARACTERISTICS (T_A = +25 °C)

Unless otherwise specified V_{CC} = V_{PS} = 3 V, I/Q DC offset = $\frac{1}{\sqrt{2}}$ DC offset = 1.5 V, I/Q Input Signal = 500 mV_{p-p} (single ended), P_{Lo1in} = -10 dBm, P_{Lo2in} = -10 dBm, (continuous wave)

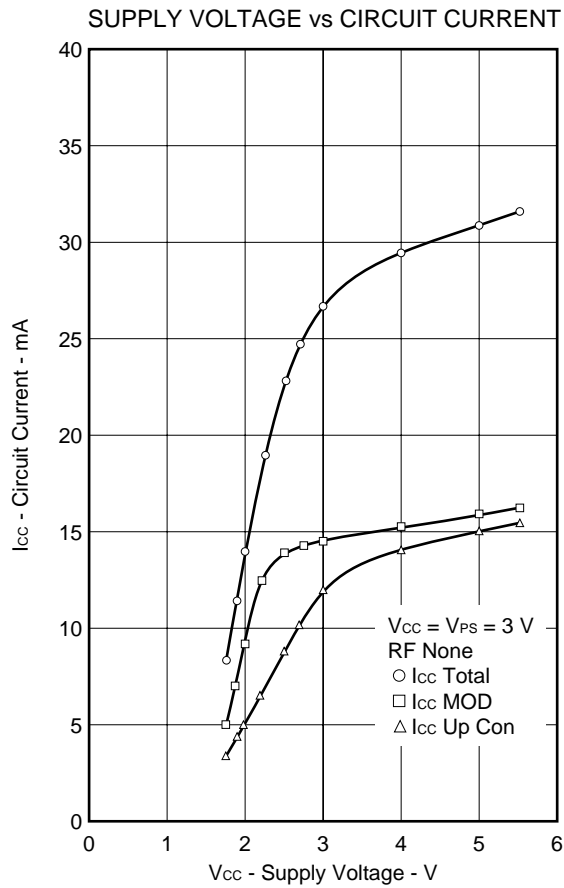

[UP CONVERTER BLOCK]

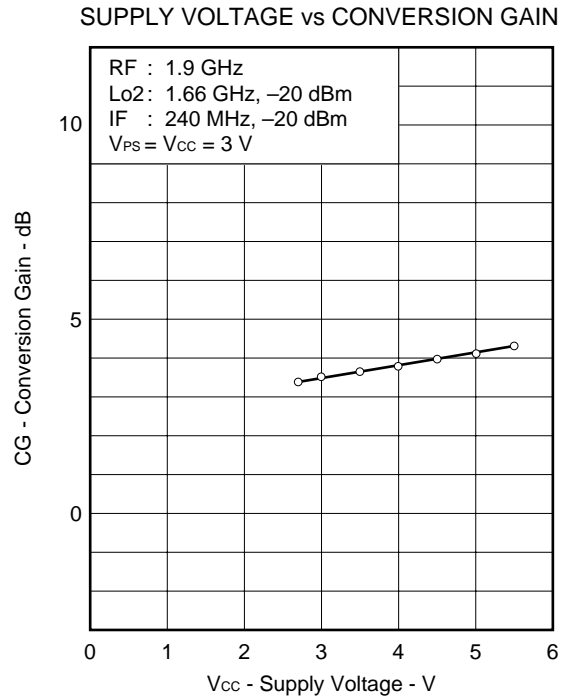

[UP CONVERTER BLOCK]

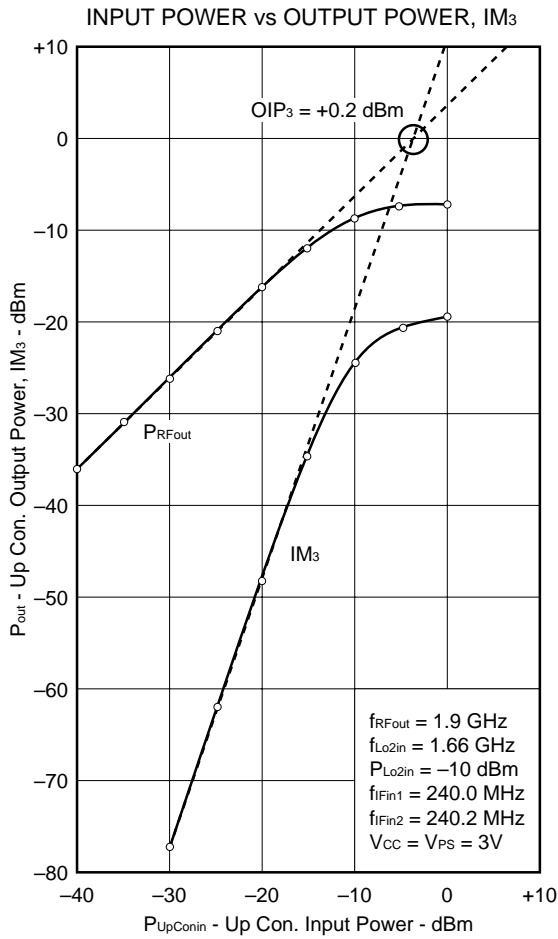

[UP CONVERTER BLOCK]

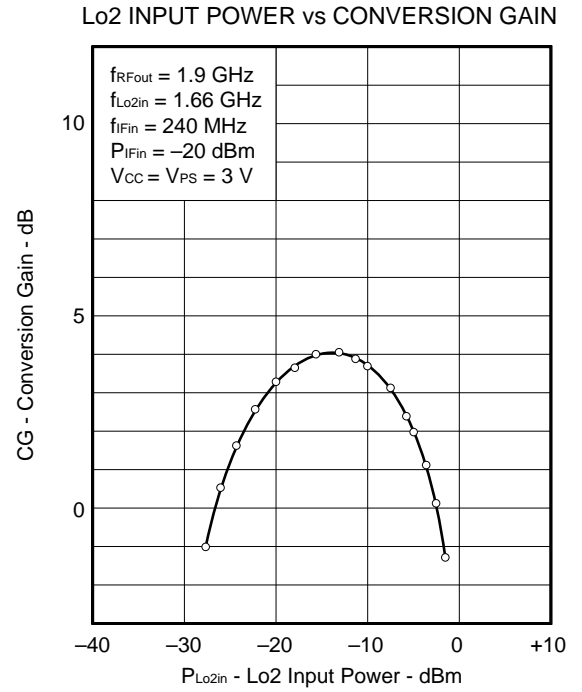

[UP CONVERTER BLOCK]

SUPPLY VOLTAGE vs CONVERSION GAIN

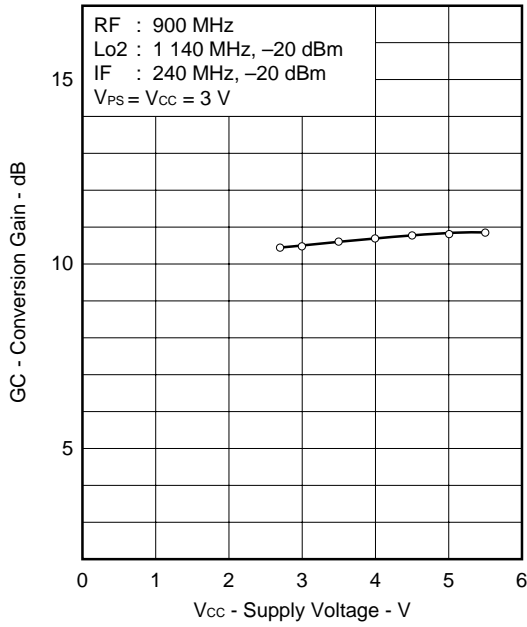

[UP CONVERTER BLOCK]

Lo2 INPUT POWER vs CONVERSION GAIN

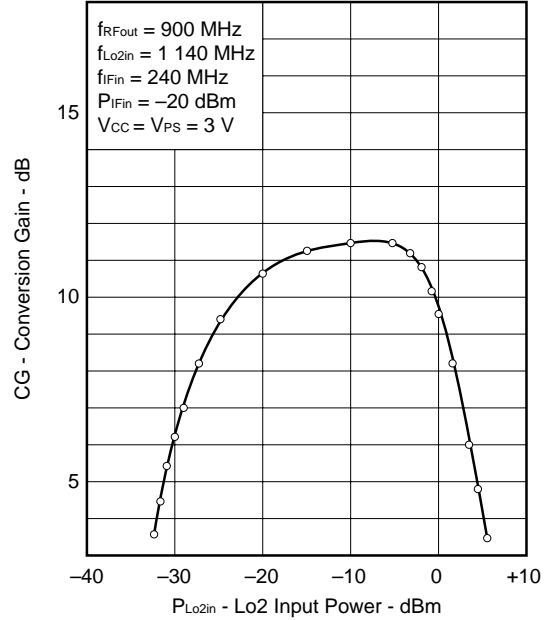

[UP CONVERTER BLOCK]

INPUT POWER vs OUTPUT POWER, IM3

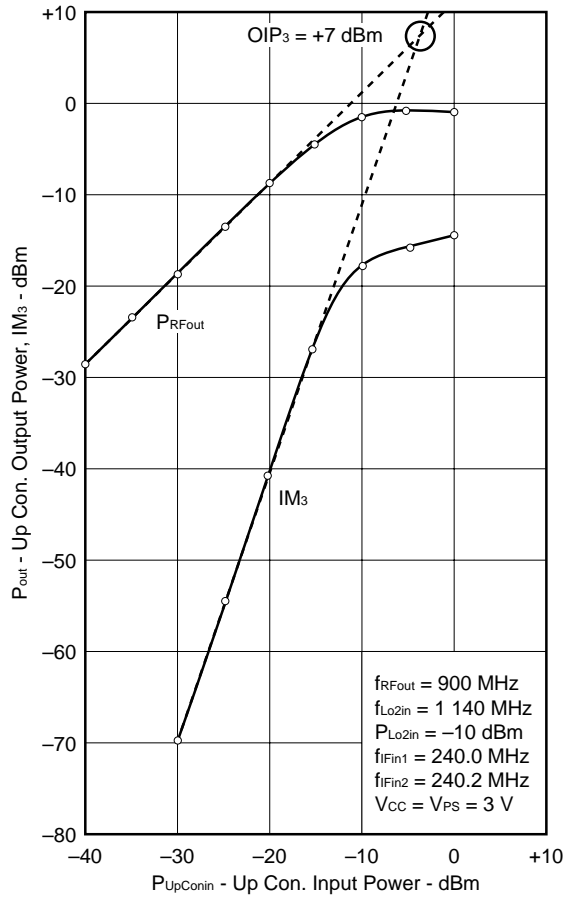

[MODULATOR BLOCK]

Lo1 INPUT POWER vs OUTPUT POWER, LOCAL LEAK, IMAGE REJECTION, I/Q 3RD ORDER INTERMODULATION DISTORTION

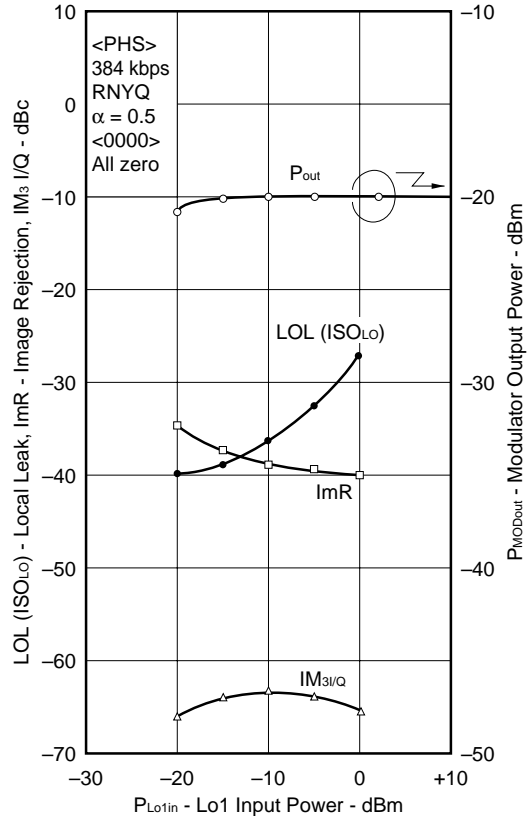

[MODULATOR BLOCK]

I/Q INPUT SIGNAL vs OUTPUT POWER, LOCAL LEAK, IMAGE REJECTION, I/Q 3RD ORDER INTERMODULATION DISTORTION

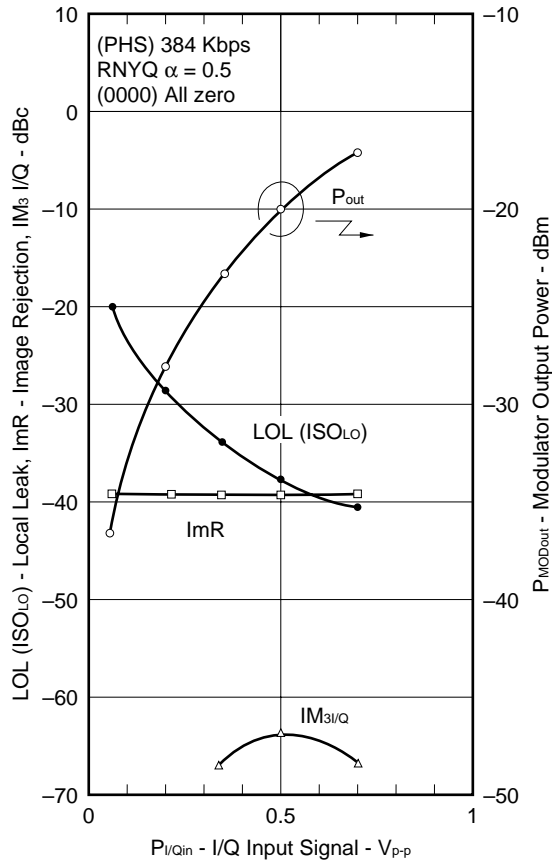

[MODULATOR BLOCK]

Lo1 INPUT FREQUENCY vs OUTPUT POWER, LOCAL LEAK, IMAGE REJECTION, I/Q 3RD ORDER INTERMODULATION DISTORTION

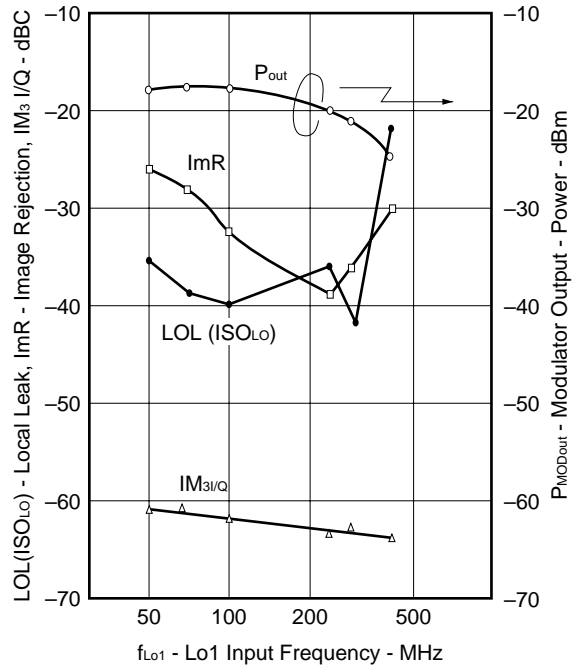

[MODULATOR + UP CONVERTER]

I/Q INPUT SIGNAL vs VECTOR ERROR, MAGNITUDE ERROR, PHASE ERROR

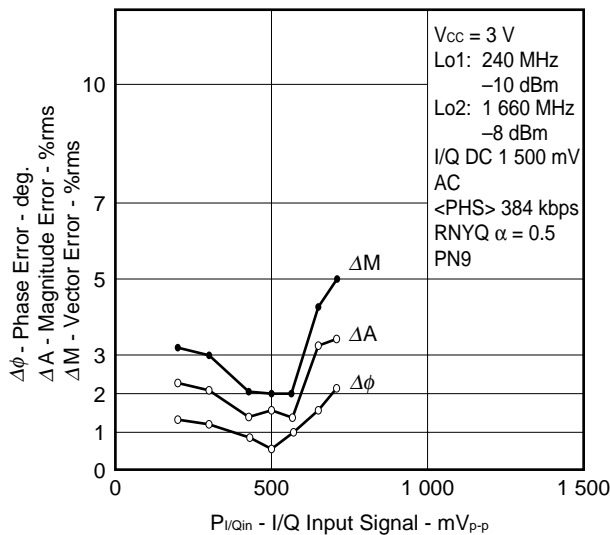

[MODULATOR BLOCK]

Lo1 INPUT FREQUENCY vs VECTOR ERROR, MAGNITUDE ERROR, PHASE ERROR

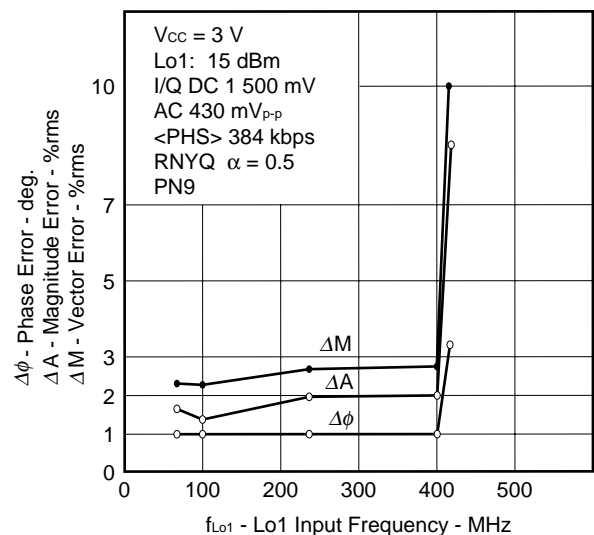

[MODULATOR + UP CONVERTER]

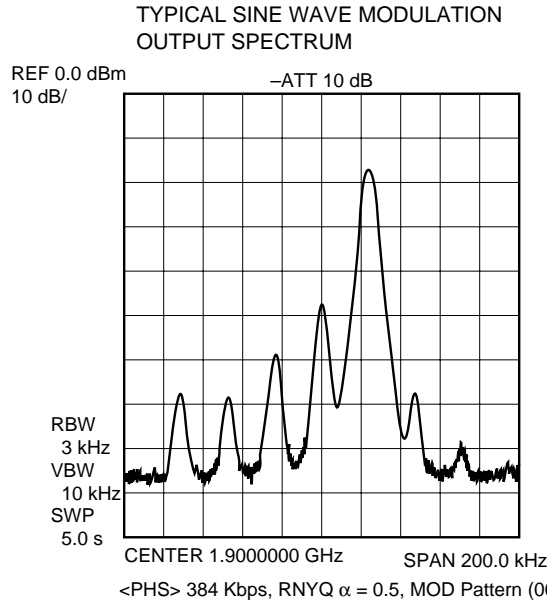

[MODULATOR BLOCK]

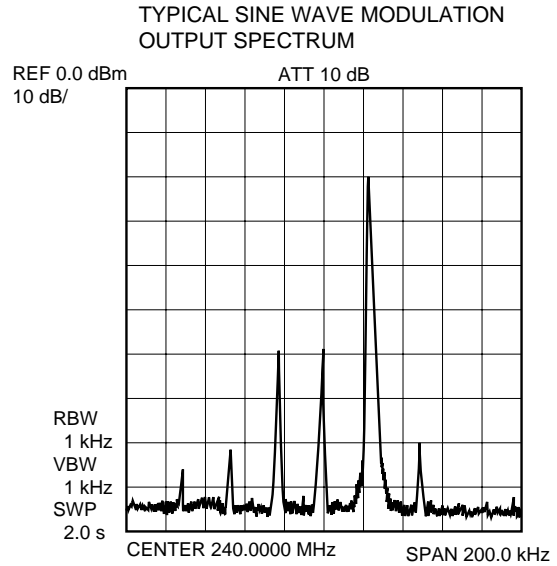

[MODULATOR + UP CONVERTER]

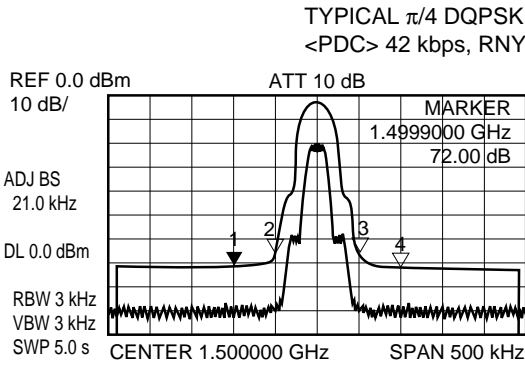

- *** Multi Marker List ***
- No. 1: 1.4999000 GHz -72.00 dB
 - No. 2: 1.4999500 GHz -66.00 dB
 - No. 3: 1.5000500 GHz -68.75 dB
 - No. 4: 1.5001000 GHz -72.00 dB

[MODULATOR BLOCK]

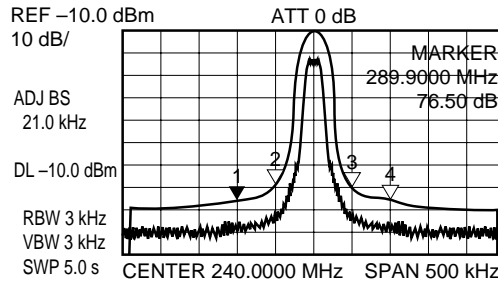

- *** Multi Marker List ***
- No. 1: 239.9000 MHz -76.50 dB
 - No. 2: 239.9500 MHz -70.50 dB
 - No. 3: 240.0500 MHz -71.00 dB
 - No. 4: 240.1000 MHz -75.75 dB

[MODULATOR + UP CONVERTER]

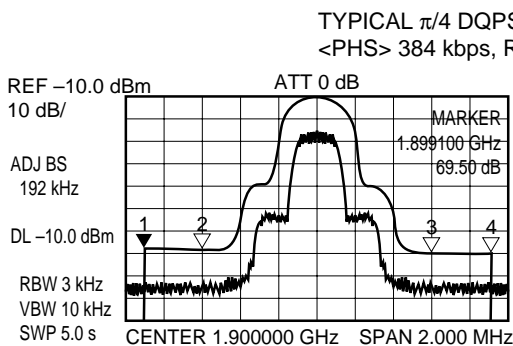

- *** Multi Marker List ***
- No. 1: 1.899100 GHz -69.50 dB
 - No. 2: 1.899400 GHz -69.00 dB
 - No. 3: 1.900600 GHz -69.00 dB
 - No. 4: 1.900900 GHz -69.50 dB

[MODULATOR BLOCK]

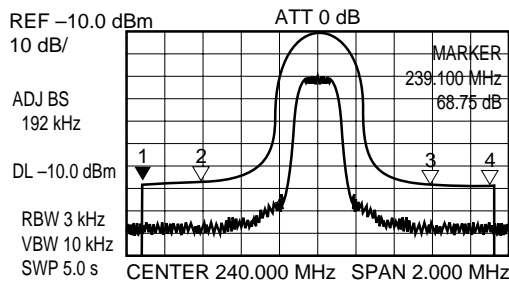

- *** Multi Marker List ***
- No. 1: 239.100 MHz -68.75 dB
 - No. 2: 239.400 MHz -68.25 dB
 - No. 3: 240.600 MHz -68.25 dB
 - No. 4: 240.900 MHz -69.00 dB

RFout OUTPUT IMPEDANCE

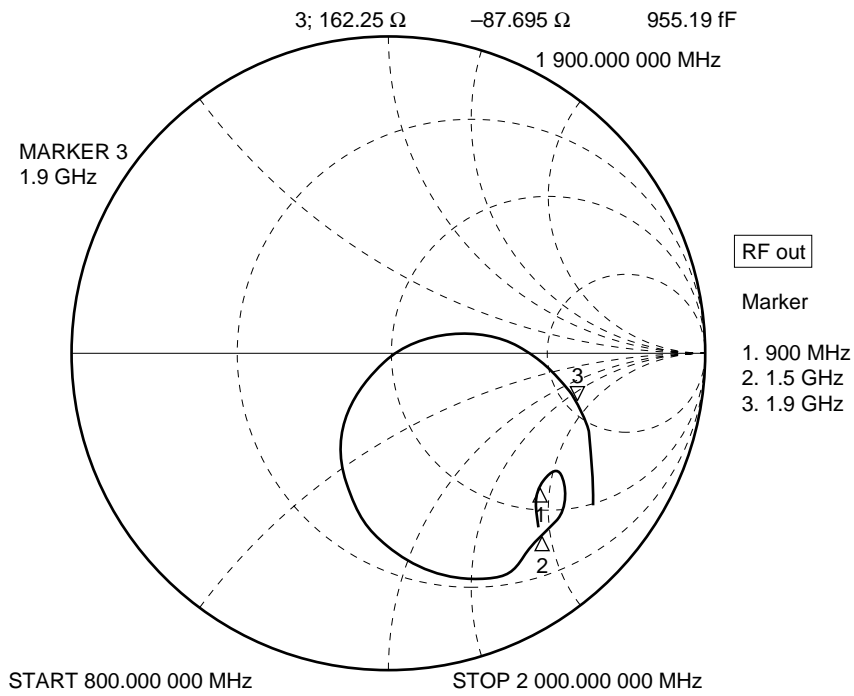

Lo2in INPUT IMPEDANCE

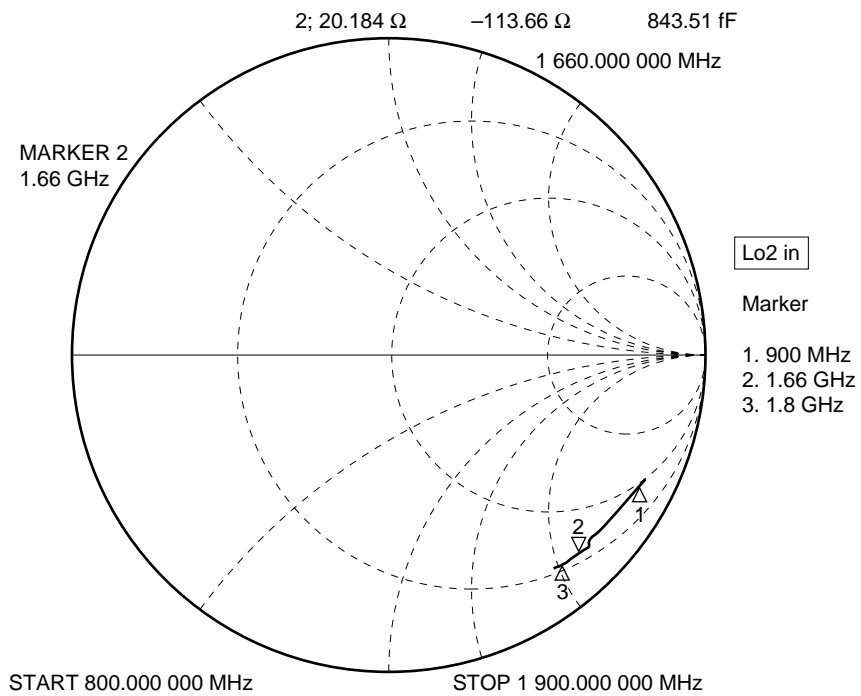

MODout OUTPUT IMPEDANCE

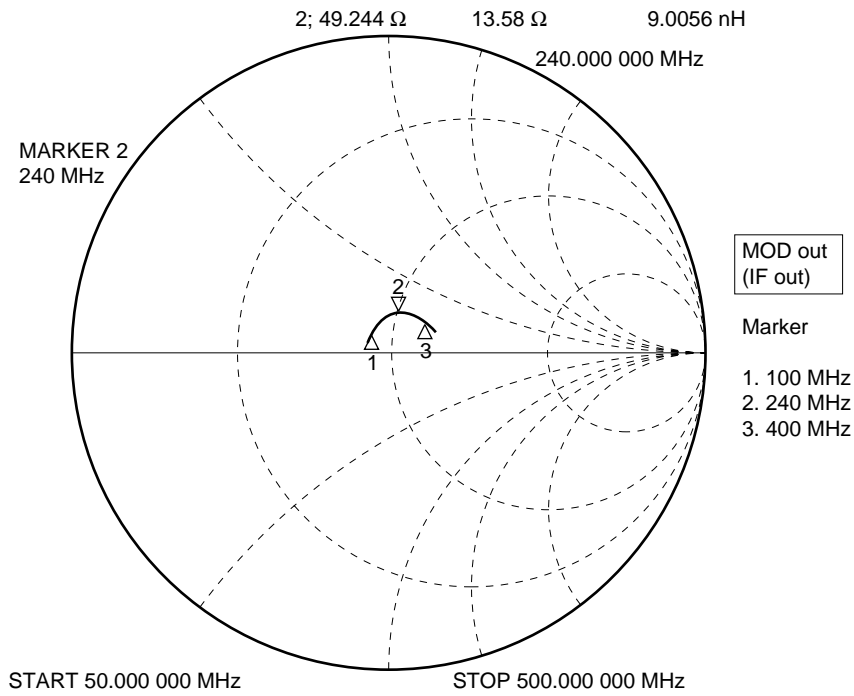

UP CON. in INPUT IMPEDANCE

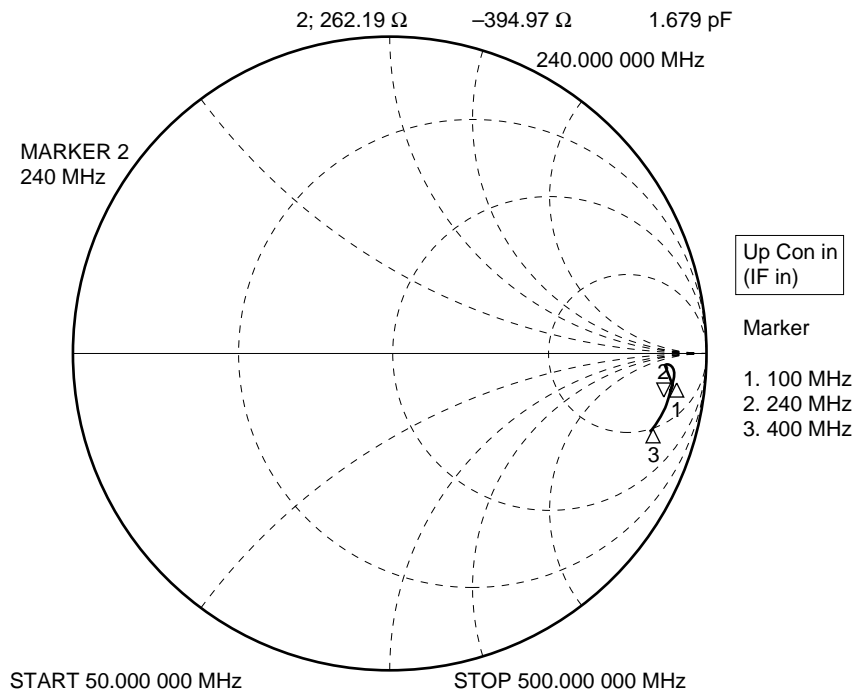

Lo1in INPUT IMPEDANCE

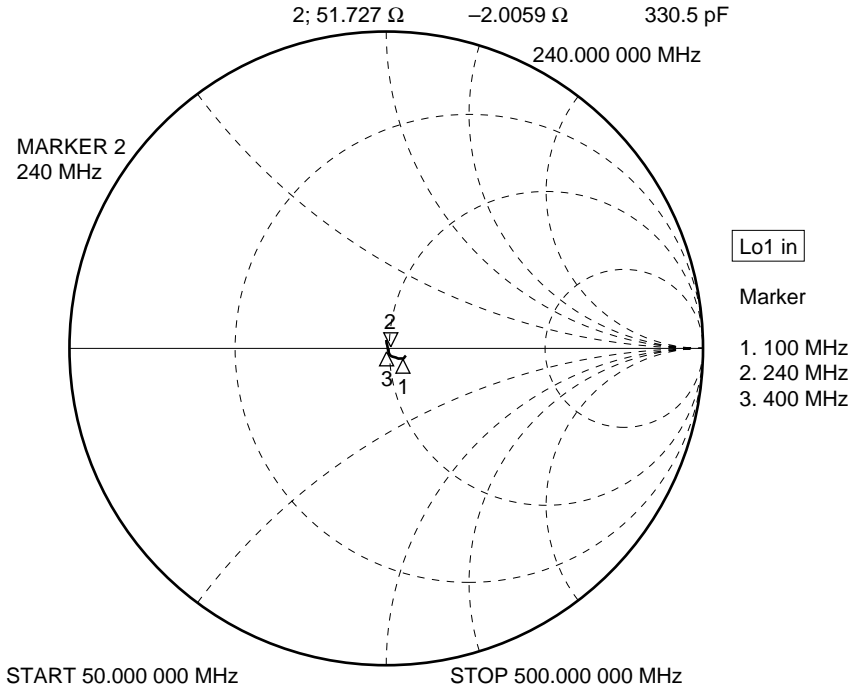

TEST CIRCUIT
(f_{RF} = 1.9 GHz)

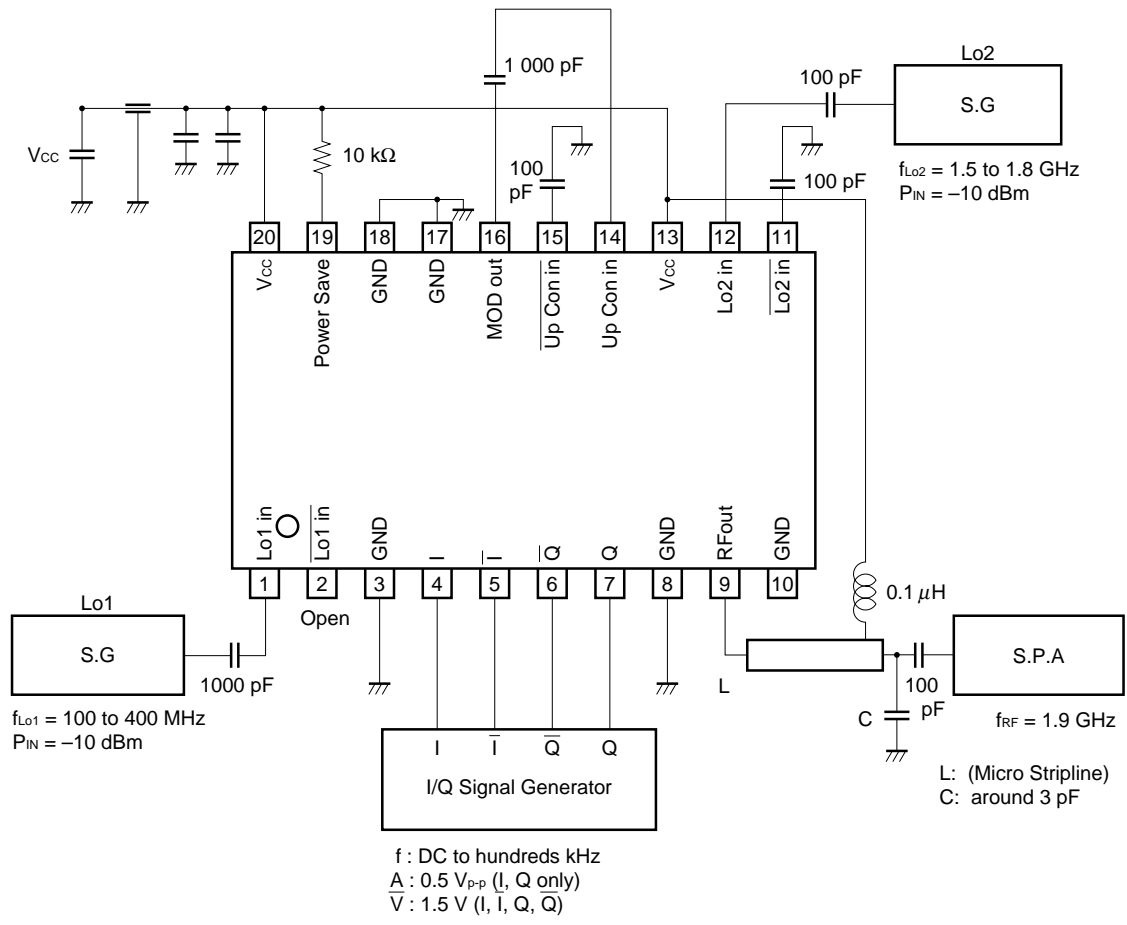

TEST BOARD

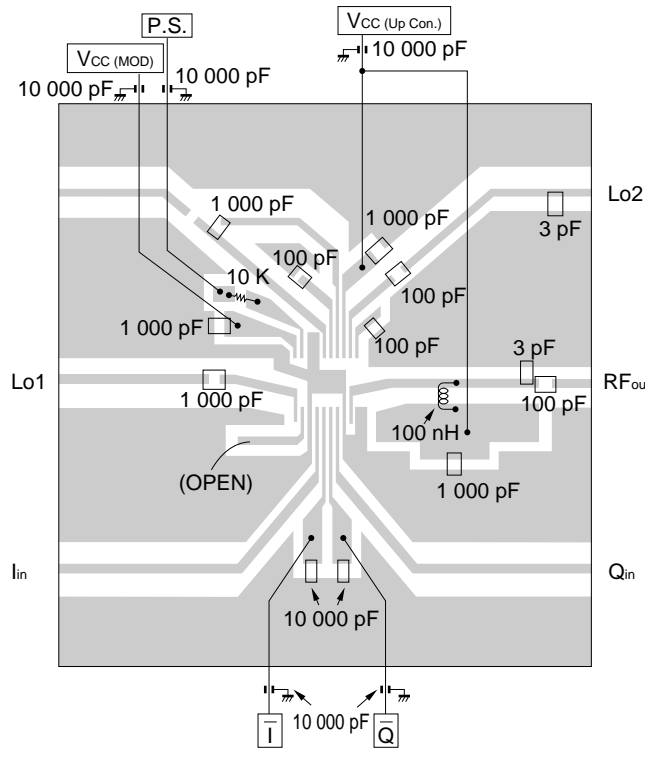

In case of this test board, the output signal from MOD. is directly connected to the up converter input port through 1000 pF, which is DC coupling.

$f_{RF} = 1.9 \text{ GHz}$
 $f_{Lo2} = 1.66 \text{ GHz}$
 $f_{Lo1} = 240 \text{ MHz}$

We recommend to insert a low pass filter between MOD output and up converter input port to reject harmonics of the Lo1 signal and to avoid saturation of the up converter.

■ GND

PACKAGE DIMENSIONS

★ 20 PIN PLASTIC SSOP (225 mil) (UNIT: mm)

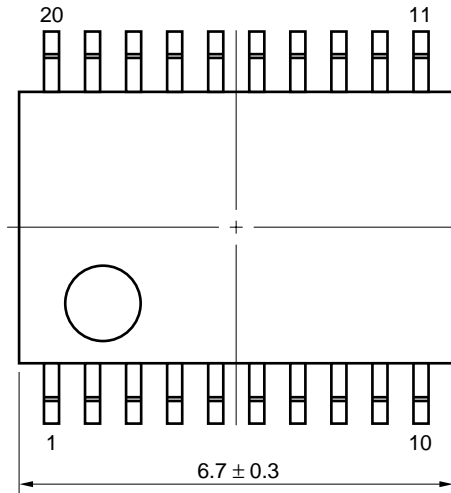

detail of lead end

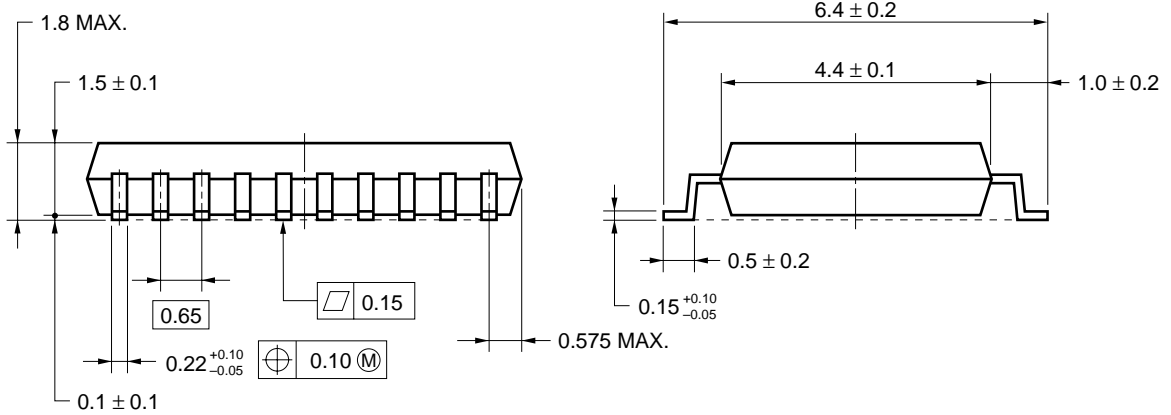
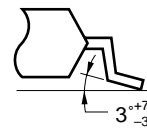

NOTE Each lead centerline is located within 0.10 mm of its true position (T.P.) at maximum material condition.

NOTE ON CORRECT USE

- (1) Observe precautions for handling because of electrostatic sensitive devices.
- (2) Form a ground pattern as wide as possible to keep the minimum ground impedance (to prevent undesired oscillation).
- (3) Keep the track length of the ground pins as short as possible.
- (4) Connect a bypass capacitor (e.g. 1 000 pF) to the V_{CC} pin.
- (5) I, Q DC offset voltage should be same as the I, Q DC offset voltage (to prevent changing the local leak level with power save control.)

RECOMMENDED SOLDERING CONDITIONS

This product should be soldered in the following recommended conditions. Other soldering methods and conditions than the recommended conditions are to be consulted with our sales representatives.

μPC8104GR

Soldering Method	Soldering Conditions	Symbol
Infrared ray reflow	Peak package's surface temperature: 235 °C or below, Reflow time: 30 seconds or below (210 °C or higher), Number of reflow process: 3, Exposure limit ^{Note} : None	IR35-00-3
VPS	Peak package's surface temperature: 215 °C or below, Reflow time: 40 seconds or below (200 °C or higher), Number of reflow process: 3, Exposure limit ^{Note} : None	VP15-00-3
Wave soldering	Solder temperature: 260 °C or below Flow time: 10 seconds or below, Number of reflow process: 1, Exposure limit ^{Note} : None	WS60-00-1
Partial heating method	Terminal temperature: 300 °C or below Flow time: 3 seconds/pin or below, Exposure limit ^{Note} : None	

Note Exposure limit before soldering after dry-pack package is opened.
Storage conditions: 25 °C and relative humidity at 65 % or less.

Caution Apply only a single process at once, except for "Partial heating method".
For details of recommended soldering conditions for surface mounting, refer to information document SEMICONDUCTOR DEVICE MOUNTING TECHNOLOGY MANUAL (C10535E)

The application circuits and their parameters are for reference only and are not intended for use in actual design-ins.

[MEMO]

- **The information in this document is subject to change without notice. Before using this document, please confirm that this is the latest version.**
 - No part of this document may be copied or reproduced in any form or by any means without the prior written consent of NEC Corporation. NEC Corporation assumes no responsibility for any errors which may appear in this document.
 - NEC Corporation does not assume any liability for infringement of patents, copyrights or other intellectual property rights of third parties by or arising from use of a device described herein or any other liability arising from use of such device. No license, either express, implied or otherwise, is granted under any patents, copyrights or other intellectual property rights of NEC Corporation or others.
 - Descriptions of circuits, software, and other related information in this document are provided for illustrative purposes in semiconductor product operation and application examples. The incorporation of these circuits, software, and information in the design of the customer's equipment shall be done under the full responsibility of the customer. NEC Corporation assumes no responsibility for any losses incurred by the customer or third parties arising from the use of these circuits, software, and information.
 - While NEC Corporation has been making continuous effort to enhance the reliability of its semiconductor devices, the possibility of defects cannot be eliminated entirely. To minimize risks of damage or injury to persons or property arising from a defect in an NEC semiconductor device, customers must incorporate sufficient safety measures in its design, such as redundancy, fire-containment, and anti-failure features.
 - NEC devices are classified into the following three quality grades:
"Standard", "Special", and "Specific". The Specific quality grade applies only to devices developed based on a customer designated "quality assurance program" for a specific application. The recommended applications of a device depend on its quality grade, as indicated below. Customers must check the quality grade of each device before using it in a particular application.
 - Standard: Computers, office equipment, communications equipment, test and measurement equipment, audio and visual equipment, home electronic appliances, machine tools, personal electronic equipment and industrial robots
 - Special: Transportation equipment (automobiles, trains, ships, etc.), traffic control systems, anti-disaster systems, anti-crime systems, safety equipment and medical equipment (not specifically designed for life support)
 - Specific: Aircraft, aerospace equipment, submersible repeaters, nuclear reactor control systems, life support systems or medical equipment for life support, etc.
- The quality grade of NEC devices is "Standard" unless otherwise specified in NEC's Data Sheets or Data Books. If customers intend to use NEC devices for applications other than those specified for Standard quality grade, they should contact an NEC sales representative in advance.