

DESCRIPTION The 2SC2785 is designed for use in driver stage of AF amplifier and low speed switching.

- FEATURES**
- High Voltage $V_{CE0} : 50 \text{ V MIN.}$
 - Excellent h_{FE} Linearity $: 0.92 \text{ TYP.}$
 $h_{FE1} (0.1 \text{ mA})/h_{FE2} (1.0 \text{ mA})$
 - Complementary to the NEC 2SA1175 PNP Transistor.

ABSOLUTE MAXIMUM RATINGS

- Maximum Temperatures
- Storage Temperature $-55 \text{ to } +150 \text{ }^\circ\text{C}$
 - Junction Temperature $+150 \text{ }^\circ\text{C}$ Maximum
- Maximum Power Dissipation ($T_a = 25 \text{ }^\circ\text{C}$)
- Total Power Dissipation 250 mW
- Maximum Voltages and Currents ($T_a = 25 \text{ }^\circ\text{C}$)
- V_{CBO} Collector to Base Voltage 60 V
 - V_{CEO} Collector to Emitter Voltage 50 V
 - V_{EBO} Emitter to Base Voltage 5.0 V
 - I_C Collector Current 100 mA
 - I_B Base Current 20 mA

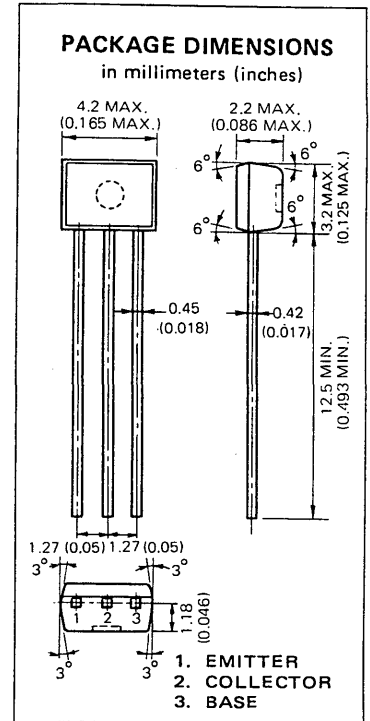

ELECTRICAL CHARACTERISTICS ($T_a = 25 \text{ }^\circ\text{C}$)

SYMBOL	CHARACTERISTIC	MIN.	TYP.	MAX.	UNIT	TEST CONDITIONS
h_{FE1}	DC Current Gain	50	185			$V_{CE}=6.0 \text{ V}, I_C=0.1 \text{ mA}$
h_{FE2}	DC Current Gain	110	200	600		$V_{CE}=6.0 \text{ V}, I_C=1.0 \text{ mA}$
NF	Noise Figure		0.8	15	dB	$V_{CE}=6.0 \text{ V}, I_C=0.1 \text{ mA}, R_G=2.0 \text{ k}\Omega,$ $f=1.0 \text{ kHz}$
f_T	Gain Bandwidth Product	150	250	450	MHz	$V_{CE}=6.0 \text{ V}, I_E=-10 \text{ mA}$
C_{ob}	Collector to Base Capacitance		3.0	4.0	pF	$V_{CB}=6.0 \text{ V}, I_E=0, f=1.0 \text{ MHz}$
I_{CBO}	Collector Cutoff Current			100	nA	$V_{CB}=60 \text{ V}, I_E=0$
I_{EBO}	Emitter Cutoff Current			100	nA	$V_{EB}=5.0 \text{ V}, I_C=0$
V_{BE}	Base to Emitter Voltage	0.55	0.62	0.65	V	$V_{CE}=6.0 \text{ V}, I_C=1.0 \text{ mA}$
$V_{CE(sat)}$	Collector Saturation Voltage		0.15	0.3	V	$I_C=100 \text{ mA}, I_B=10 \text{ mA}$
$V_{BE(sat)}$	Base Saturation Voltage		0.86	1.0	V	$I_C=100 \text{ mA}, I_B=10 \text{ mA}$

Classification of h_{FE2}

Rank	RF	JF	HF	FF	EF	KF
Range	110 - 180	135 - 220	170 - 270	200 - 320	250 - 400	300 - 600

h_{FE2} Test Conditions : $V_{CE}=6.0 \text{ V}, I_C=1.0 \text{ mA}$

TYPICAL CHARACTERISTICS (Ta = 25 °C unless otherwise noted)

TOTAL POWER DISSIPATION vs. AMBIENT TEMPERATURE

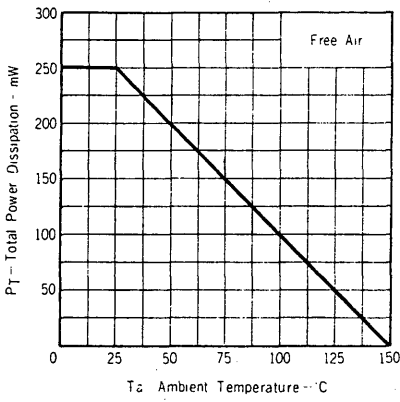

NORMALIZED COLLECTOR CUTOFF CURRENT vs. AMBIENT TEMPERATURE

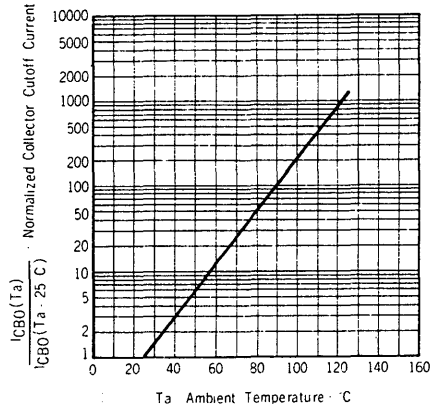

COLLECTOR CURRENT vs. COLLECTOR TO EMITTER VOLTAGE

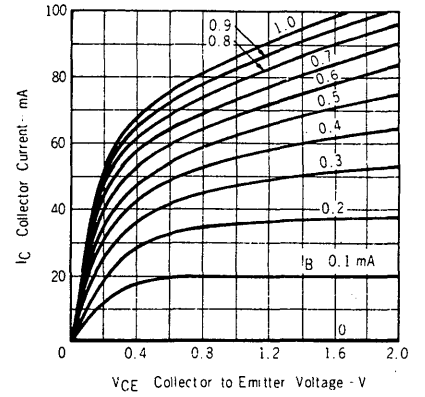

COLLECTOR CURRENT vs. COLLECTOR TO EMITTER VOLTAGE

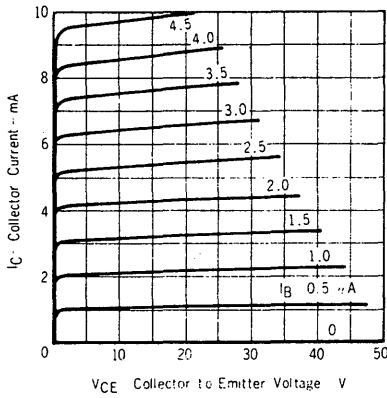

DC CURRENT GAIN vs. COLLECTOR CURRENT

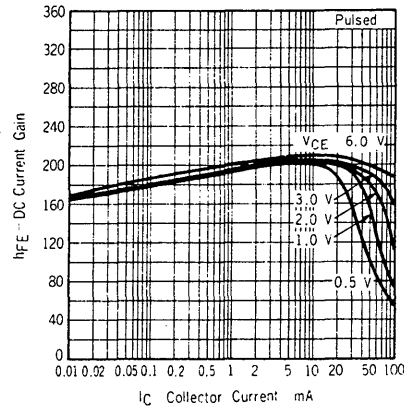

DC CURRENT GAIN vs. COLLECTOR CURRENT

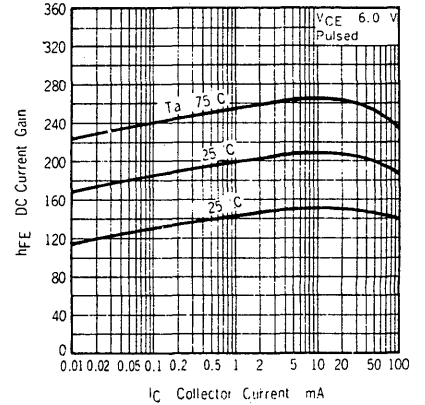

COLLECTOR CURRENT vs. BASE TO EMITTER VOLTAGE

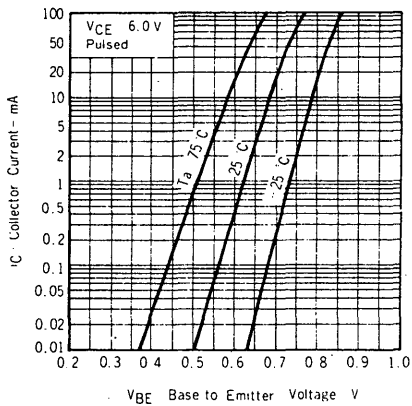

COLLECTOR AND BASE SATURATION VOLTAGE vs. COLLECTOR CURRENT

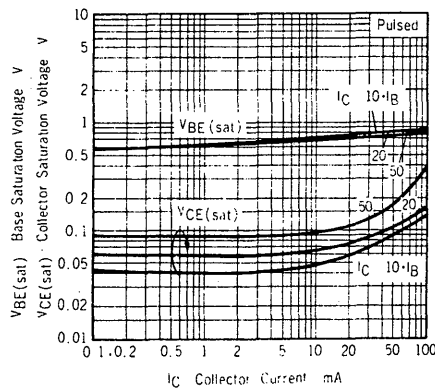

GAIN BANDWIDTH PRODUCT vs. EMITTER CURRENT

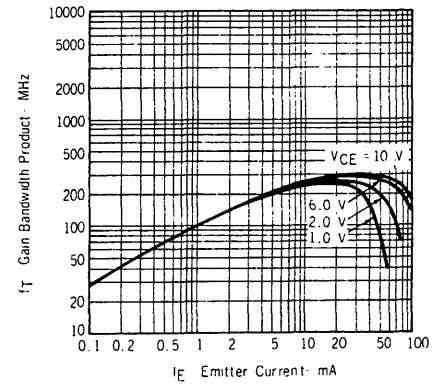

EMITTER TO BASE AND COLLECTOR TO BASE CAPACITANCE vs. REVERSE VOLTAGE

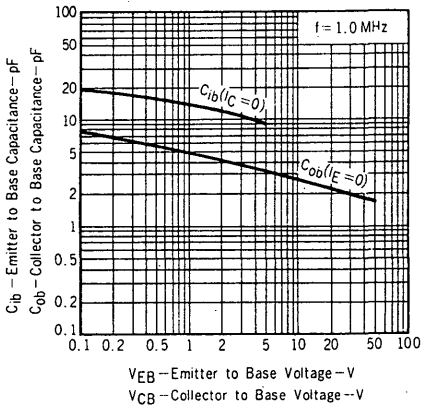

SMALL SIGNAL CURRENT GAIN vs. DC CURRENT GAIN

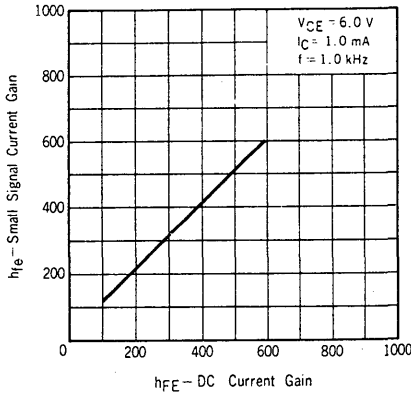

INPUT IMPEDANCE, VOLTAGE FEEDBACK RATIO AND OUTPUT ADMITTANCE vs. SMALL SIGNAL CURRENT GAIN

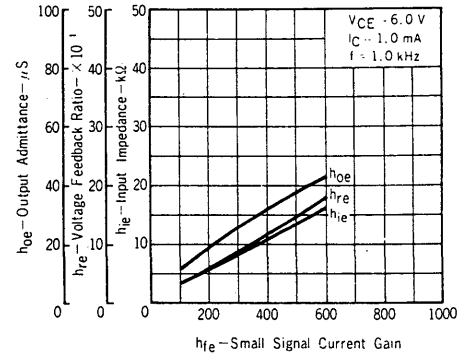

NORMALIZED h-PARAMETERS vs. COLLECTOR CURRENT

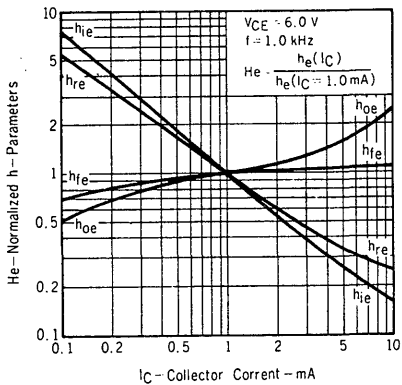

NORMALIZED h-PARAMETERS vs. COLLECTOR TO EMITTER VOLTAGE

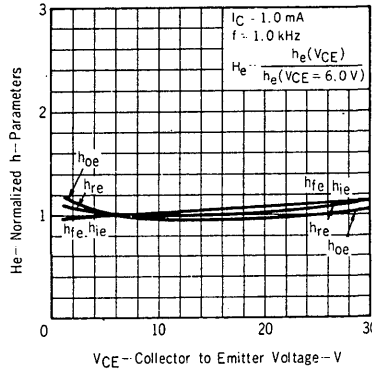

EN AND IN vs. COLLECTOR CURRENT

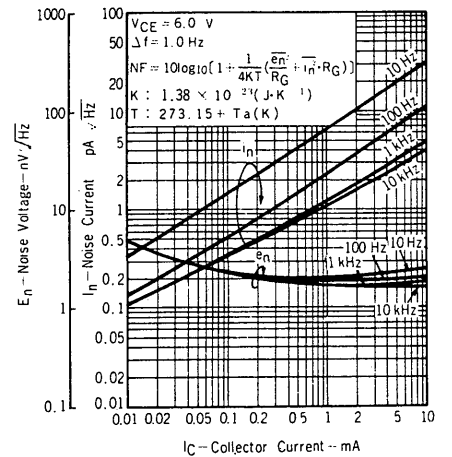

NOISE FIGURE MAP 1

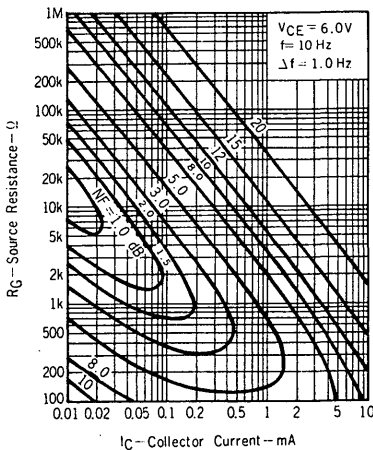

NOISE FIGURE MAP 2

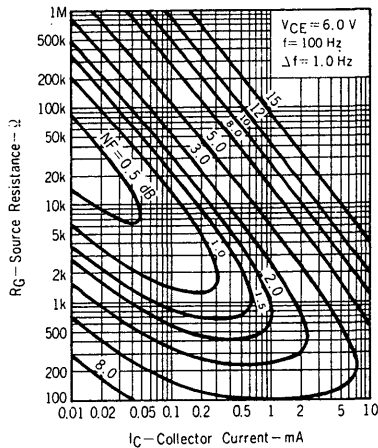

NOISE FIGURE MAP 3

