

NPN Small-Signal Darlington Transistor

This NPN small signal darlington transistor is designed for use in switching applications, such as print hammer, relay, solenoid and lamp drivers. The device is housed in the SOT-223 package, which is designed for medium power surface mount applications.

- The SOT-223 Package can be soldered using wave or reflow. The formed leads absorb thermal stress during soldering, eliminating the possibility of damage to the die
- Available in 12 mm Tape and Reel
Use BSP52T1 to order the 7 inch/1000 unit reel
Use BSP52T3 to order the 13 inch/4000 unit reel
- PNP Complement is BSP62T1

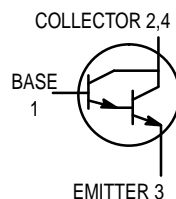

BSP52T1

Motorola Preferred Device

**MEDIUM POWER
NPN SILICON
DARLINGTON
TRANSISTOR
SURFACE MOUNT**

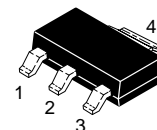

**CASE 318E-04, STYLE 1
TO-261AA**

MAXIMUM RATINGS (T_C = 25°C unless otherwise noted)

| Rating | Symbol | Value | Unit |
|---|-----------------------------------|------------|----------------|
| Collector-Emitter Voltage | V _{CES} | 80 | Vdc |
| Collector-Base Voltage | V _{CB0} | 90 | Vdc |
| Emitter-Base Voltage | V _{EBO} | 5.0 | Vdc |
| Collector Current | I _C | 500 | mAdc |
| Total Power Dissipation @ T _A = 25°C ⁽¹⁾ Derate above 25°C | P _D | 0.8 6.4 | Watts mW/°C |
| Operating and Storage Temperature Range | T _J , T _{stg} | -65 to 150 | °C |

DEVICE MARKING

AS3

THERMAL CHARACTERISTICS

| Characteristic | Symbol | Max | Unit |
|---|------------------|-----------|-----------|
| Thermal Resistance – Junction-to-Ambient (surface mounted) | R _{θJA} | 156 | °C/W |
| Maximum Temperature for Soldering Purposes Time in Solder Bath | T _L | 260 10 | °C Sec |

1. Device mounted on a FR-4 glass epoxy printed circuit board using minimum recommended footprint.

Thermal Clad is a trademark of the Bergquist Company

Preferred devices are Motorola recommended choices for future use and best overall value.

BSP52T1**ELECTRICAL CHARACTERISTICS** (continued) ($T_A = 25^\circ\text{C}$ unless otherwise noted)

| Characteristics | Symbol | Min | Max | Unit |
|---|---------------|--------------|--------|---------------|
| OFF CHARACTERISTICS | | | | |
| Collector-Base Breakdown Voltage ($I_C = 100 \mu\text{A}$, $I_E = 0$) | $V_{(BR)CBO}$ | 90 | — | Vdc |
| Emitter-Base Breakdown Voltage ($I_E = 10 \mu\text{A}$, $I_C = 0$) | $V_{(BR)EBO}$ | 5.0 | — | Vdc |
| Collector-Emitter Cutoff Current ($V_{CE} = 80 \text{ Vdc}$, $V_{BE} = 0$) | I_{CES} | — | 10 | μA |
| Emitter-Base Cutoff Current ($V_{EB} = 4.0 \text{ Vdc}$, $I_C = 0$) | I_{EBO} | — | 10 | μA |
| ON CHARACTERISTICS (2) | | | | |
| DC Current Gain ($I_C = 150 \text{ mA}$, $V_{CE} = 10 \text{ Vdc}$) ($I_C = 500 \text{ mA}$, $V_{CE} = 10 \text{ Vdc}$) | h_{FE} | 1000 2000 | — — | — |
| Collector-Emitter Saturation Voltage ($I_C = 500 \text{ mA}$, $I_B = 0.5 \text{ mA}$) | $V_{CE(sat)}$ | — | 1.3 | Vdc |
| Base-Emitter On Voltage ($I_C = 500 \text{ mA}$, $I_B = 0.5 \text{ mA}$) | $V_{BE(on)}$ | — | 1.9 | Vdc |

2. Pulse Test: Pulse Width $\leq 300 \mu\text{s}$, Duty Cycle $\leq 2.0\%$

INFORMATION FOR USING THE SOT-223 SURFACE MOUNT PACKAGE

MINIMUM RECOMMENDED FOOTPRINT FOR SURFACE MOUNTED APPLICATIONS

Surface mount board layout is a critical portion of the total design. The footprint for the semiconductor packages must be the correct size to insure proper solder connection

interface between the board and the package. With the correct pad geometry, the packages will self align when subjected to a solder reflow process.

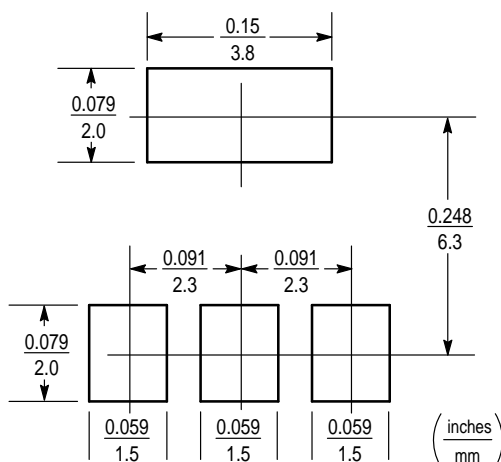

SOT-223

SOT-223 POWER DISSIPATION

The power dissipation of the SOT-223 is a function of the pad size. This can vary from the minimum pad size for soldering to a pad size given for maximum power dissipation. Power dissipation for a surface mount device is determined by $T_{J(max)}$, the maximum rated junction temperature of the die, $R_{\theta JA}$, the thermal resistance from the device junction to ambient, and the operating temperature, T_A . Using the values provided on the data sheet for the SOT-223 package, P_D can be calculated as follows:

$$P_D = \frac{T_{J(max)} - T_A}{R_{\theta JA}}$$

The values for the equation are found in the maximum ratings table on the data sheet. Substituting these values into the equation for an ambient temperature T_A of 25°C, one can calculate the power dissipation of the device which in this case is 0.8 watts.

$$P_D = \frac{150^\circ\text{C} - 25^\circ\text{C}}{156^\circ\text{C/W}} = 0.8 \text{ watts}$$

The 156°C/W for the SOT-223 package assumes the use of the recommended footprint on a glass epoxy printed circuit board to achieve a power dissipation of 0.8 watts. There are other alternatives to achieving higher power dissipation from the SOT-223 package. One is to increase the area of the collector pad. By increasing the area of the collector pad, the

power dissipation can be increased. Although the power dissipation can almost be doubled with this method, area is taken up on the printed circuit board which can defeat the purpose of using surface mount technology. A graph of $R_{\theta JA}$ versus collector pad area is shown in Figure 1.

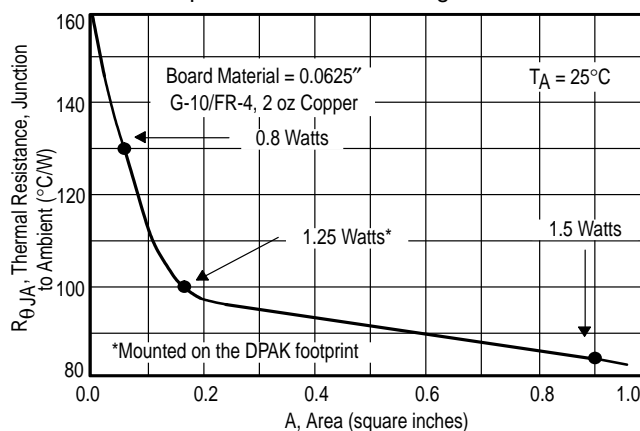

Figure 1. Thermal Resistance versus Collector Pad Area for the SOT-223 Package (Typical)

Another alternative would be to use a ceramic substrate or an aluminum core board such as Thermal Clad™. Using a board material such as Thermal Clad, an aluminum core board, the power dissipation can be doubled using the same footprint.

SOLDER STENCIL GUIDELINES

Prior to placing surface mount components onto a printed circuit board, solder paste must be applied to the pads. A solder stencil is required to screen the optimum amount of solder paste onto the footprint. The stencil is made of brass

or stainless steel with a typical thickness of 0.008 inches. The stencil opening size for the SOT-223 package should be the same as the pad size on the printed circuit board, i.e., a 1:1 registration.

SOLDERING PRECAUTIONS

The melting temperature of solder is higher than the rated temperature of the device. When the entire device is heated to a high temperature, failure to complete soldering within a short time could result in device failure. Therefore, the following items should always be observed in order to minimize the thermal stress to which the devices are subjected.

- Always preheat the device.
- The delta temperature between the preheat and soldering should be 100°C or less.*
- When preheating and soldering, the temperature of the leads and the case must not exceed the maximum temperature ratings as shown on the data sheet. When using infrared heating with the reflow soldering method, the difference should be a maximum of 10°C.

- The soldering temperature and time should not exceed 260°C for more than 10 seconds.
- When shifting from preheating to soldering, the maximum temperature gradient should be 5°C or less.
- After soldering has been completed, the device should be allowed to cool naturally for at least three minutes. Gradual cooling should be used as the use of forced cooling will increase the temperature gradient and result in latent failure due to mechanical stress.
- Mechanical stress or shock should not be applied during cooling

* Soldering a device without preheating can cause excessive thermal shock and stress which can result in damage to the device.

TYPICAL SOLDER HEATING PROFILE

For any given circuit board, there will be a group of control settings that will give the desired heat pattern. The operator must set temperatures for several heating zones, and a figure for belt speed. Taken together, these control settings make up a heating “profile” for that particular circuit board. On machines controlled by a computer, the computer remembers these profiles from one operating session to the next. Figure 7 shows a typical heating profile for use when soldering a surface mount device to a printed circuit board. This profile will vary among soldering systems but it is a good starting point. Factors that can affect the profile include the type of soldering system in use, density and types of components on the board, type of solder used, and the type of board or substrate material being used. This profile shows temperature versus time. The line on the graph shows the

actual temperature that might be experienced on the surface of a test board at or near a central solder joint. The two profiles are based on a high density and a low density board. The Vitronics SMD310 convection/infrared reflow soldering system was used to generate this profile. The type of solder used was 62/36/2 Tin Lead Silver with a melting point between 177–189°C. When this type of furnace is used for solder reflow work, the circuit boards and solder joints tend to heat first. The components on the board are then heated by conduction. The circuit board, because it has a large surface area, absorbs the thermal energy more efficiently, then distributes this energy to the components. Because of this effect, the main body of a component may be up to 30 degrees cooler than the adjacent solder joints.

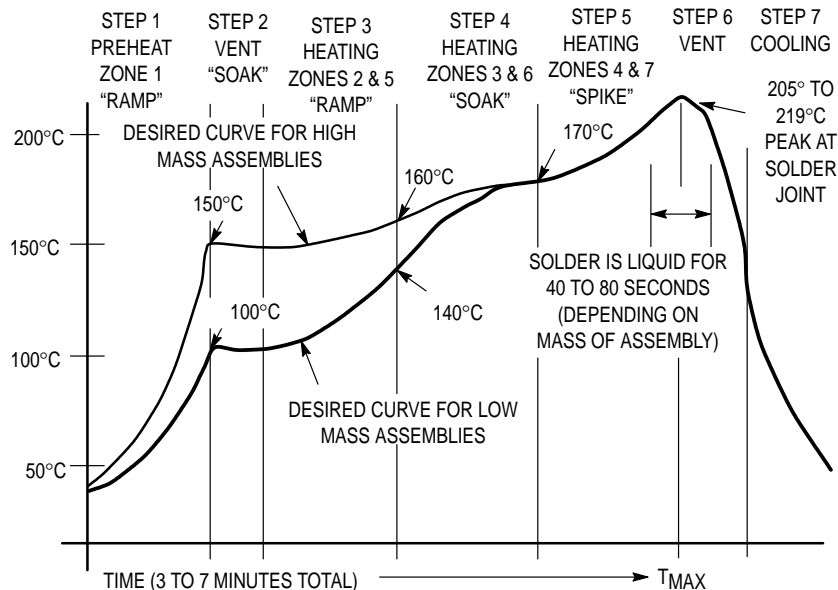
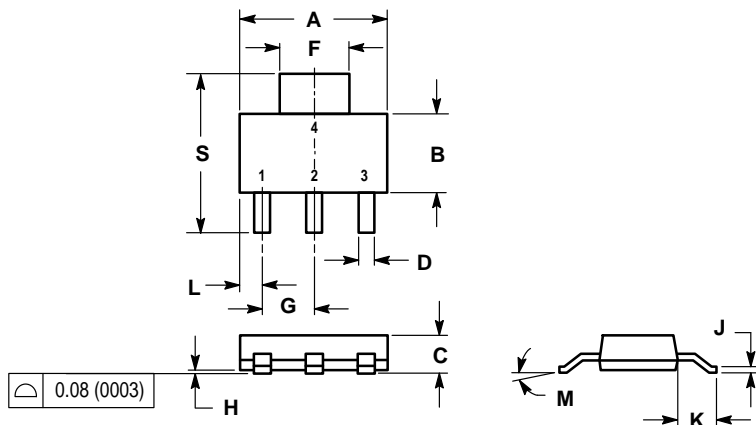

Figure 2. Typical Solder Heating Profile

PACKAGE DIMENSIONS



- NOTES:
 1. DIMENSIONING AND TOLERANCING PER ANSI Y14.5M, 1982.
 2. CONTROLLING DIMENSION: INCH.

| DIM | INCHES | | MILLIMETERS | |
|-----|--------|--------|-------------|-------|
| | MIN | MAX | MIN | MAX |
| A | 0.249 | 0.263 | 6.30 | 6.70 |
| B | 0.130 | 0.145 | 3.30 | 3.70 |
| C | 0.060 | 0.068 | 1.50 | 1.75 |
| D | 0.024 | 0.035 | 0.60 | 0.89 |
| F | 0.115 | 0.126 | 2.90 | 3.20 |
| G | 0.087 | 0.094 | 2.20 | 2.40 |
| H | 0.0008 | 0.0040 | 0.020 | 0.100 |
| J | 0.009 | 0.014 | 0.24 | 0.35 |
| K | 0.060 | 0.078 | 1.50 | 2.00 |
| L | 0.033 | 0.041 | 0.85 | 1.05 |
| M | 0° | 10° | 0° | 10° |
| S | 0.264 | 0.287 | 6.70 | 7.30 |

- STYLE 1:
 PIN 1. BASE
 2. COLLECTOR
 3. EMITTER
 4. COLLECTOR

**CASE 318E-04
 ISSUE H
 TO-261AA**

Motorola reserves the right to make changes without further notice to any products herein. Motorola makes no warranty, representation or guarantee regarding the suitability of its products for any particular purpose, nor does Motorola assume any liability arising out of the application or use of any product or circuit, and specifically disclaims any and all liability, including without limitation consequential or incidental damages. "Typical" parameters can and do vary in different applications. All operating parameters, including "Typicals" must be validated for each customer application by customer's technical experts. Motorola does not convey any license under its patent rights nor the rights of others. Motorola products are not designed, intended, or authorized for use as components in systems intended for surgical implant into the body, or other applications intended to support or sustain life, or for any other application in which the failure of the Motorola product could create a situation where personal injury or death may occur. Should Buyer purchase or use Motorola products for any such unintended or unauthorized application, Buyer shall indemnify and hold Motorola and its officers, employees, subsidiaries, affiliates, and distributors harmless against all claims, costs, damages, and expenses, and reasonable attorney fees arising out of, directly or indirectly, any claim of personal injury or death associated with such unintended or unauthorized use, even if such claim alleges that Motorola was negligent regarding the design or manufacture of the part. Motorola and  are registered trademarks of Motorola, Inc. Motorola, Inc. is an Equal Opportunity/Affirmative Action Employer.

How to reach us:

USA/EUROPE: Motorola Literature Distribution;
P.O. Box 20912; Phoenix, Arizona 85036. 1-800-441-2447

JAPAN: Nippon Motorola Ltd.; Tatsumi-SPD-JLDC, Toshikatsu Otsuki,
6F Seibu-Butsuryu-Center, 3-14-2 Tatsumi Koto-Ku, Tokyo 135, Japan. 03-3521-8315

MFAX: RMFAX0@email.sps.mot.com - TOUCHTONE (602) 244-6609
INTERNET: <http://Design-NET.com>

HONG KONG: Motorola Semiconductors H.K. Ltd.; 8B Tai Ping Industrial Park,
51 Ting Kok Road, Tai Po, N.T., Hong Kong. 852-26629298

