

FRD Type : F10P20FR

OUTLINE DRAWING

構造 : 拡散型シリコンダイオード(F R D)
 Construction: Diffusion-type Silicon Diode

用途 : 高周波整流用
 Application : High Frequency Rectification

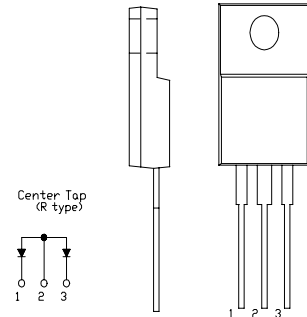

最大定格 / Maximum Ratings

Approx Net Weight:1.75g

Rating	Symbol	F10P20FR		Unit
くり返しピーク逆電圧 Repetitive Peak Reverse Voltage	V_{RRM}	200		V
非くり返しピーク逆電圧 Non-repetitive Peak Reverse Voltage	V_{RSM}	220		V
平均整流電流 Average Rectified Output Current	I_O	10	$T_c=117$ 50 Hz, 正弦全波通電抵抗負荷 Full Sine Wave Resistive Load	A
実効順電流 RMS Forward Current	$I_{F(RMS)}$	11.1		A
サージ順電流 Surge Forward Current	I_{FSM}	80	50 Hz 正弦全波, 1サイクル, 非くり返し Full Sine Wave, 1cycle, Non-repetitive	A
動作接合温度範囲 Operating Junction Temperature Range	T_{jw}	- 40 ~ + 150		
保存温度範囲 Storage Temperature Range	T_{stg}	- 40 ~ + 150		
締め付けトルク Mounting torque		0.5	推奨値 Recommended value	N·m

電氣的・熱的特性 / Electrical · Thermal Characteristics

Characteristics	Symbol	Conditions	Min	Typ	Max.	Unit
ピーク逆電流 Peak Reverse Current	I_{RM}	$T_j=25$, $V_{RM}=V_{RRM}$ per Arm	-	-	20	μA
ピーク順電圧 Peak Forward Voltage	V_{FM}	$T_j=25$, $I_{FM}= 5A$ per Arm	-	-	0.98	V
逆回復時間 Reverse Recovery Time	t_{rr}	$I_{FM}= 5A$, -di/dt= 50 A/ μs , $T_a= 25$	-	-	35	ns
熱抵抗 Thermal Resistance	$R_{th(j-c)}$	接合部・ケース間 Junction to Case	-	-	3	/W
	$R_{th(c-f)}$	ケース・フィン間 Case to Fin	-	-	1.5	

F 1 0 P _ F R 外形図 (mm)

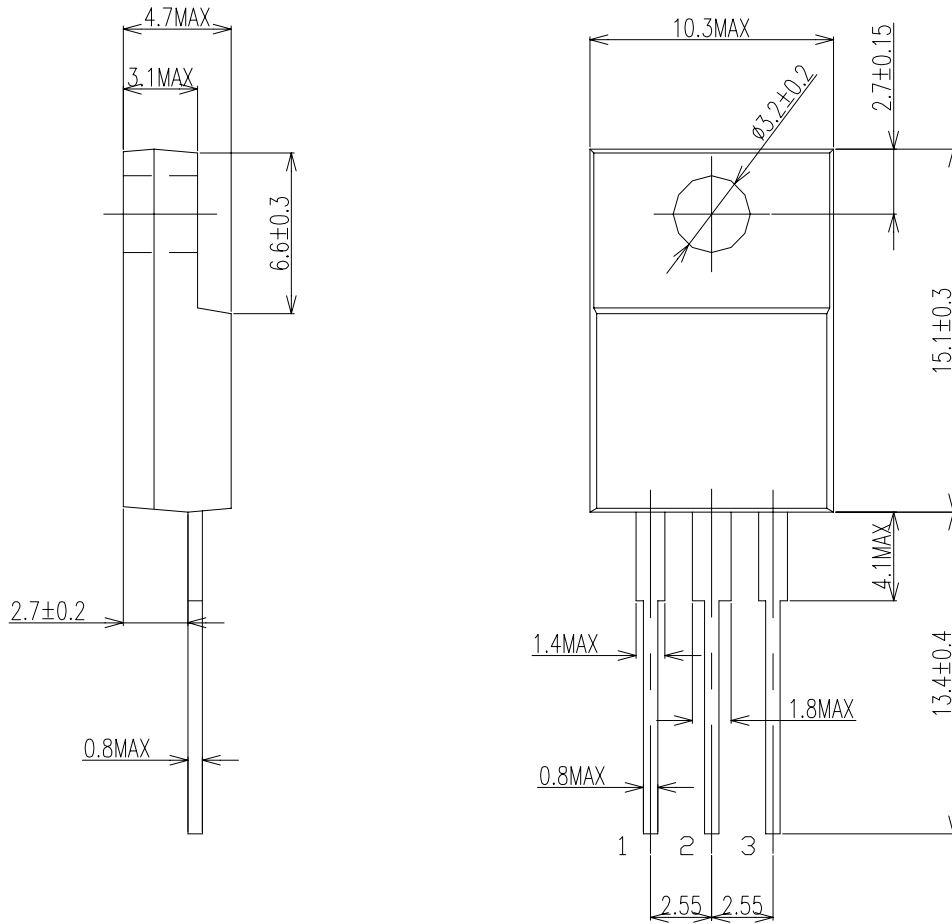

Center Tap
(R type)

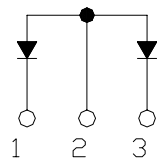

順電压特性
FORWARD CURRENT VS. VOLTAGE

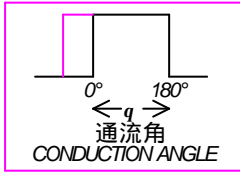
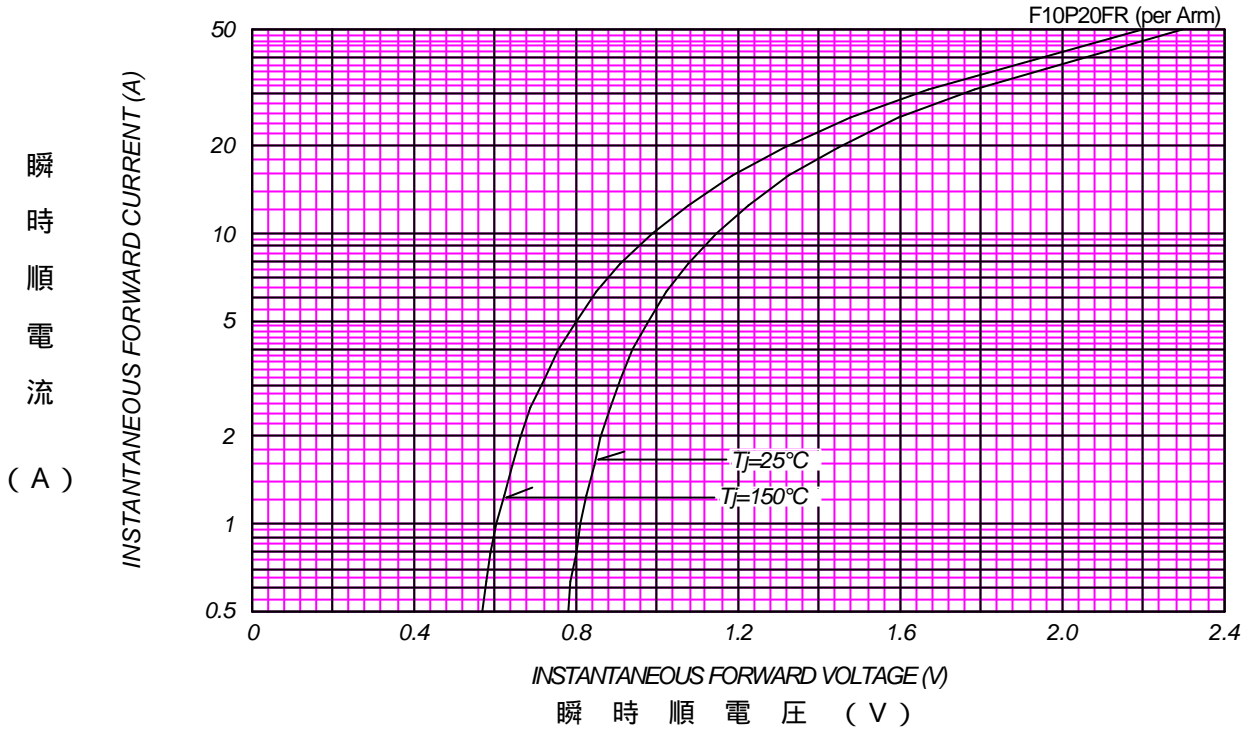

平均順電力損失特性
AVERAGE FORWARD POWER DISSIPATION

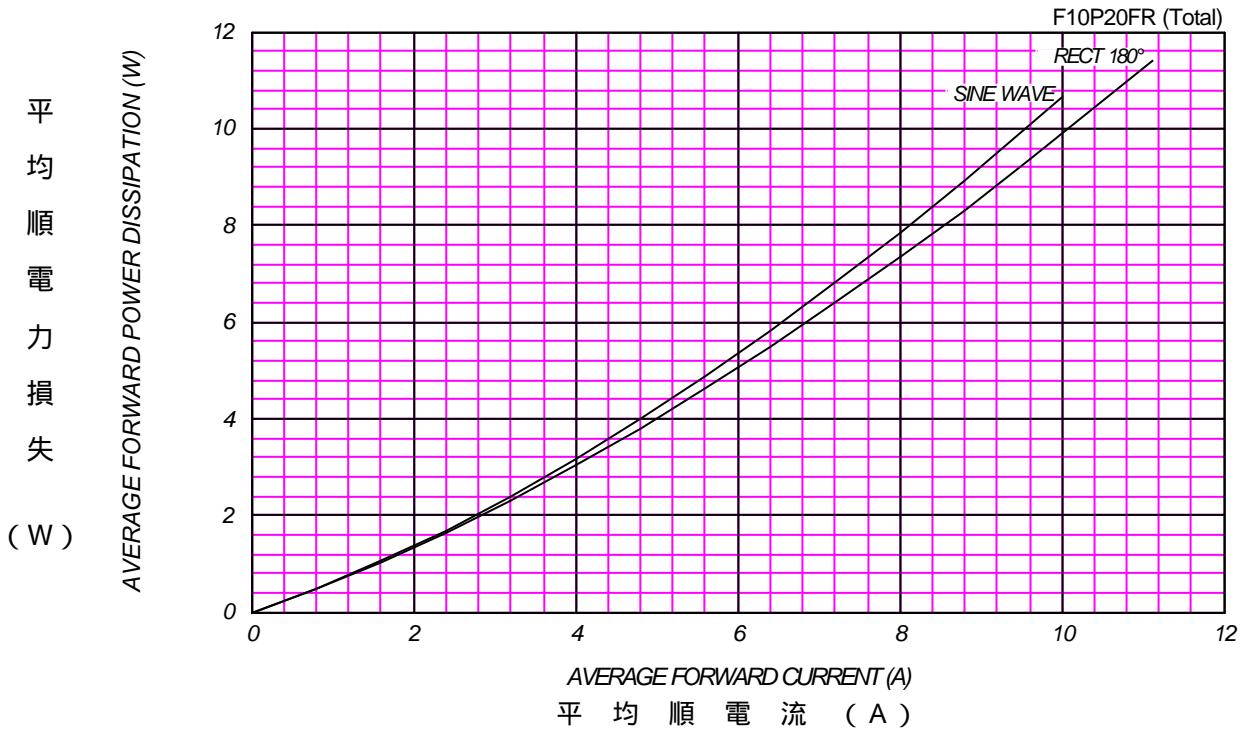

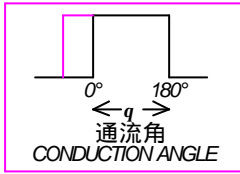

平均順電流 - ケース温度定格
AVERAGE FORWARD CURRENT VS. CASE TEMPERATURE

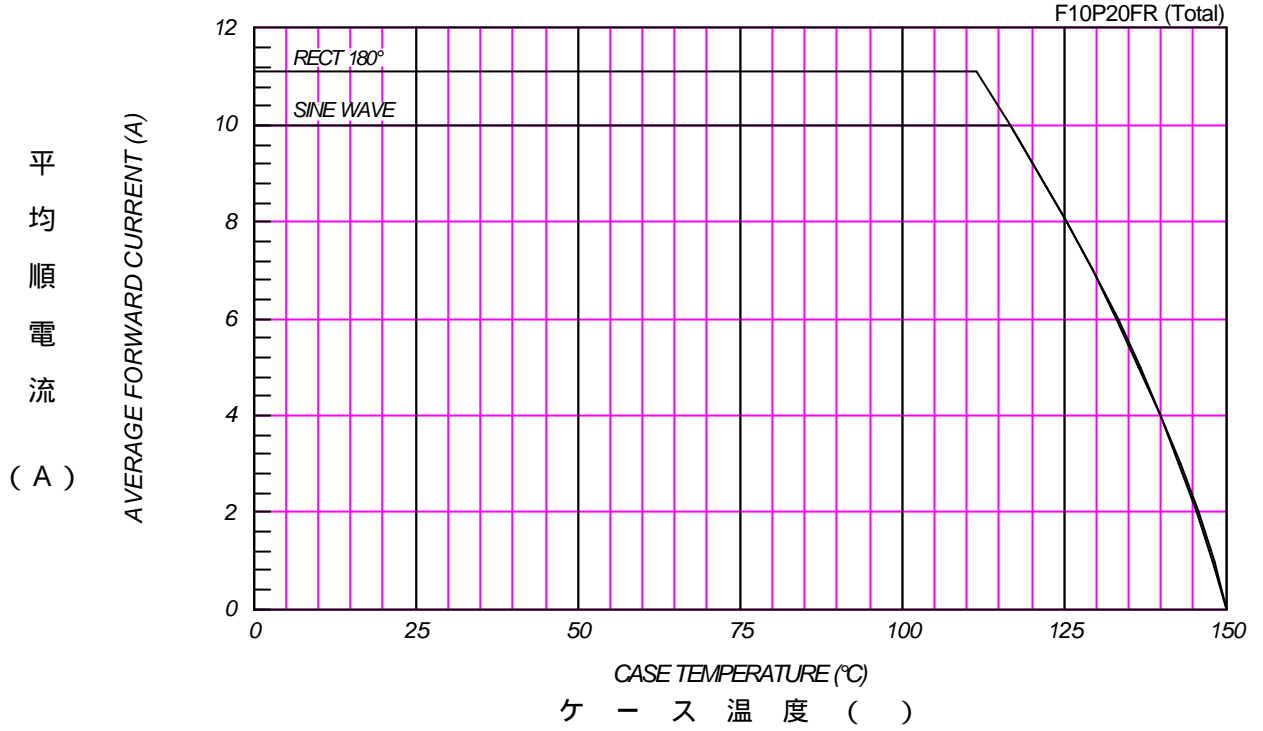

サージ順電流定格
SURGE CURRENT RATINGS

f=50Hz, Sine Wave, Non-Repetitive, No Load

