

# FS10KMJ-2

HIGH-SPEED SWITCHING USE

## FS10KMJ-2



- 4V DRIVE
- $V_{DSS}$  ..... 100V
- $r_{DS(ON)}$  (MAX) .....  $0.19\Omega$
- $I_D$  ..... 10A
- Integrated Fast Recovery Diode (TYP.) ..... 95ns
- $V_{iso}$  ..... 2000V

## OUTLINE DRAWING

Dimensions in mm

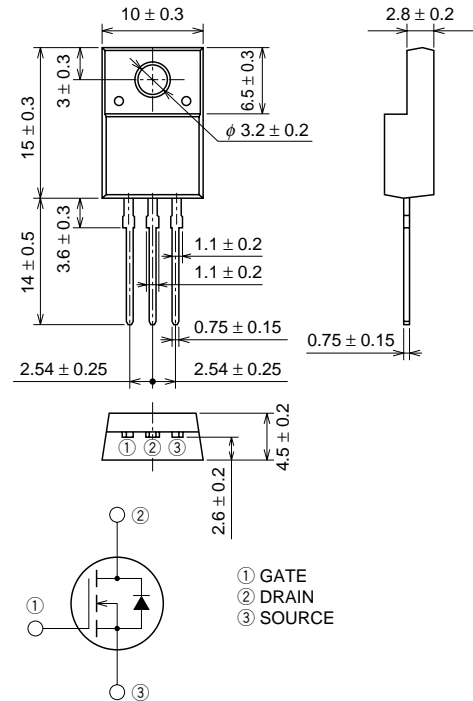

TO-220FN

## APPLICATION

Motor control, Lamp control, Solenoid control  
DC-DC converter, etc.

## MAXIMUM RATINGS (Tc = 25°C)

Symbol	Parameter	Conditions	Ratings	Unit
$V_{DSS}$	Drain-source voltage	$V_{GS} = 0V$	100	V
$V_{GSS}$	Gate-source voltage	$V_{DS} = 0V$	$\pm 20$	V
$I_D$	Drain current		10	A
$I_{DM}$	Drain current (Pulsed)		40	A
$I_{DA}$	Avalanche drain current (Pulsed)	$L = 100\mu H$	10	A
$I_S$	Source current		10	A
$I_{SM}$	Source current (Pulsed)		40	A
$P_D$	Maximum power dissipation		20	W
$T_{ch}$	Channel temperature		-55 ~ +150	°C
$T_{stg}$	Storage temperature		-55 ~ +150	°C
$V_{iso}$	Isolation voltage	AC for 1minute, Terminal to case	2000	V
—	Weight	Typical value	2.0	g

**ELECTRICAL CHARACTERISTICS** (Tch = 25°C)

Symbol	Parameter	Test conditions	Limits			Unit
			Min.	Typ.	Max.	
V(BR)DSS	Drain-source breakdown voltage	Id = 1mA, Vgs = 0V	100	—	—	V
IgSS	Gate-source leakage current	Vgs = ±20V, Vds = 0V	—	—	±0.1	μA
IbSS	Drain-source leakage current	Vds = 100V, Vgs = 0V	—	—	0.1	mA
VGS(th)	Gate-source threshold voltage	Id = 1mA, Vds = 10V	1.0	1.5	2.0	V
rDS(ON)	Drain-source on-state resistance	Id = 5A, Vgs = 10V	—	0.14	0.19	Ω
rDS(ON)	Drain-source on-state resistance	Id = 5A, Vgs = 4V	—	0.16	0.21	Ω
VDS(ON)	Drain-source on-state voltage	Id = 5A, Vgs = 10V	—	0.70	0.95	V
yfs	Forward transfer admittance	Id = 5A, Vds = 5V	—	13	—	S
Ciss	Input capacitance	Vds = 10V, Vgs = 0V, f = 1MHz	—	800	—	pF
Coss	Output capacitance		—	125	—	pF
Crss	Reverse transfer capacitance		—	45	—	pF
td(on)	Turn-on delay time	VDD = 50V, Id = 5A, Vgs = 10V, RGEN = RGS = 50Ω	—	14	—	ns
tr	Rise time		—	15	—	ns
td(off)	Turn-off delay time		—	65	—	ns
tf	Fall time		—	40	—	ns
VSD	Source-drain voltage	Is = 5A, Vgs = 0V	—	1.0	1.5	V
Rth(ch-c)	Thermal resistance	Channel to case	—	—	6.25	°C/W
trr	Reverse recovery time	Is = 10A, dis/dt = -100A/μs	—	95	—	ns

**PERFORMANCE CURVES**

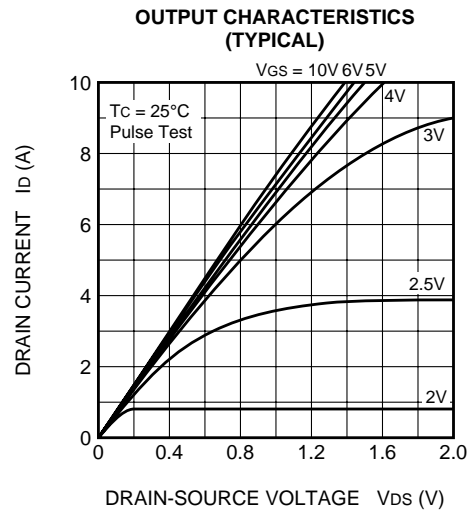
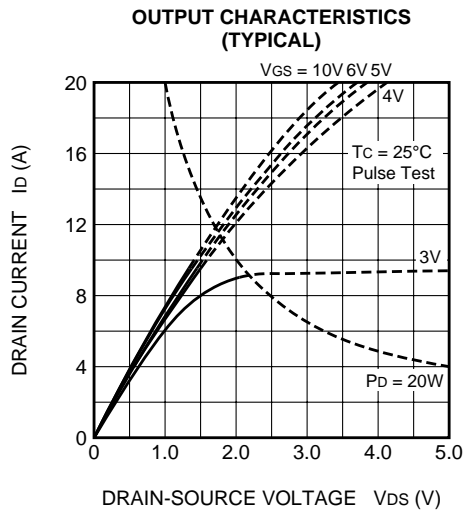
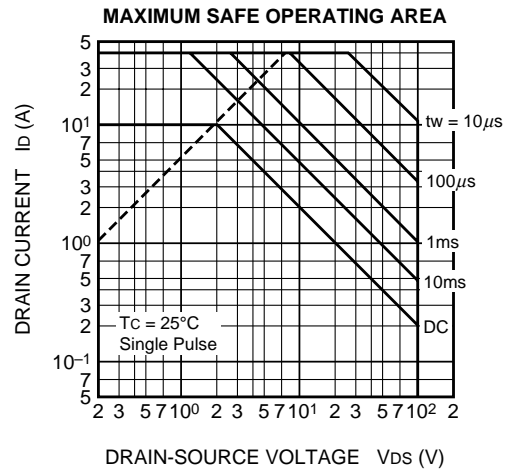
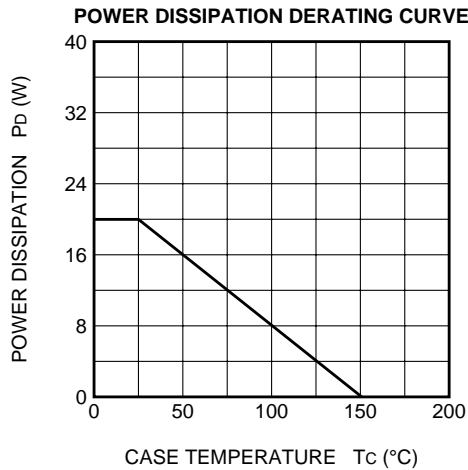

ON-STATE VOLTAGE VS. GATE-SOURCE VOLTAGE (TYPICAL)

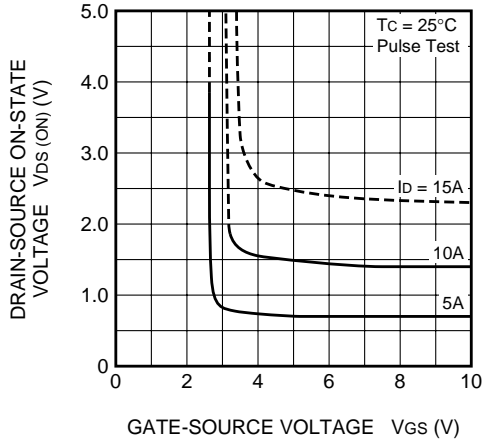

ON-STATE RESISTANCE VS. DRAIN CURRENT (TYPICAL)

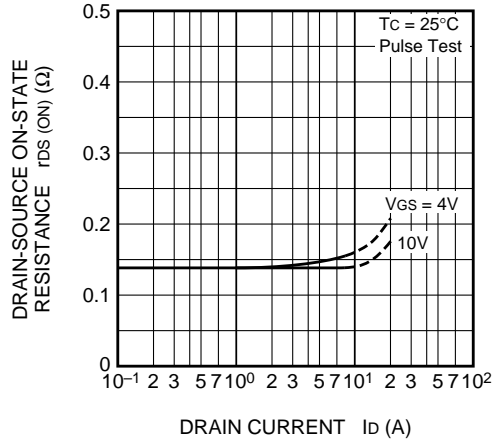

TRANSFER CHARACTERISTICS (TYPICAL)

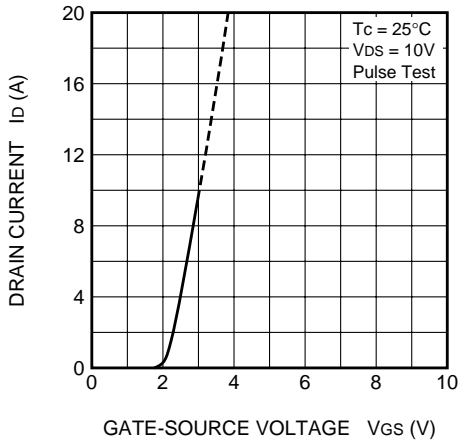

FORWARD TRANSFER ADMITTANCE VS. DRAIN CURRENT (TYPICAL)

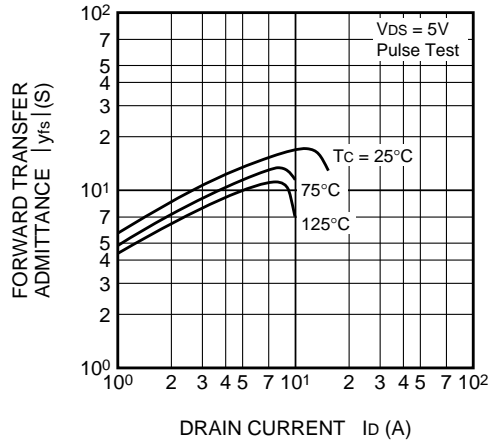

CAPACITANCE VS. DRAIN-SOURCE VOLTAGE (TYPICAL)

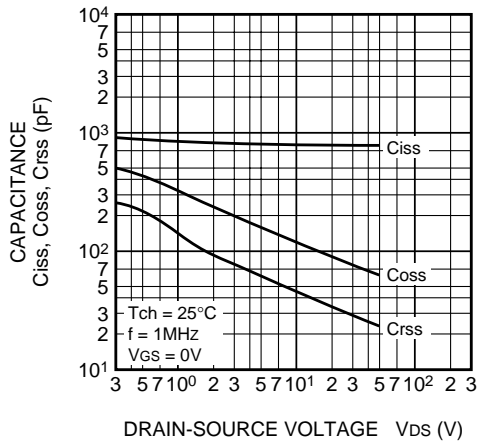

SWITCHING CHARACTERISTICS (TYPICAL)

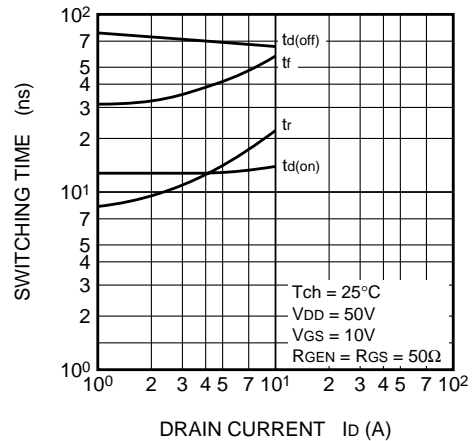

GATE-SOURCE VOLTAGE VS. GATE CHARGE (TYPICAL)

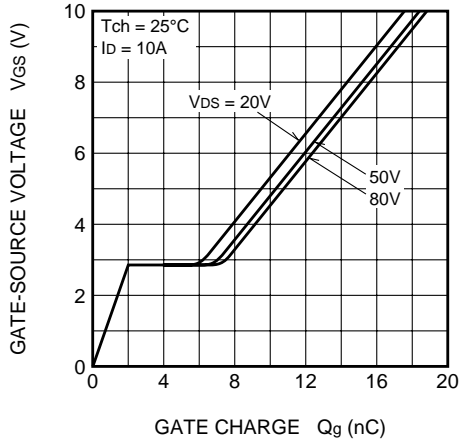

SOURCE-DRAIN DIODE FORWARD CHARACTERISTICS (TYPICAL)

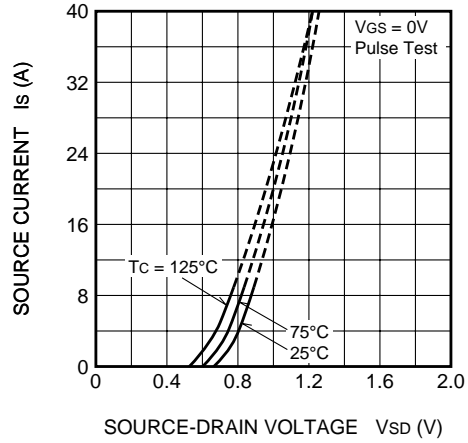

ON-STATE RESISTANCE VS. CHANNEL TEMPERATURE (TYPICAL)

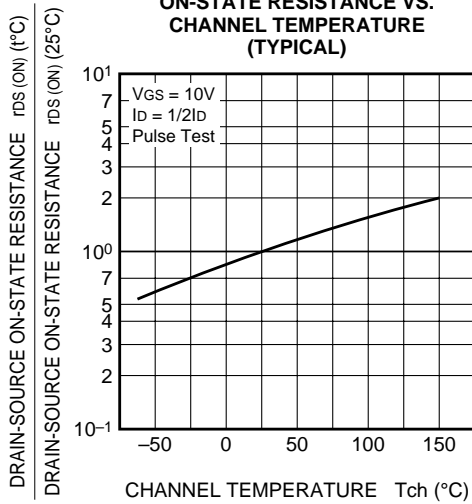

THRESHOLD VOLTAGE VS. CHANNEL TEMPERATURE (TYPICAL)

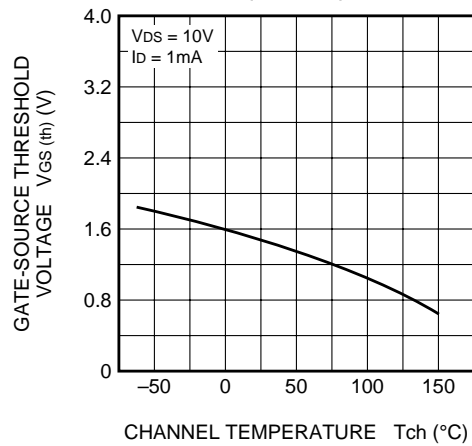

BREAKDOWN VOLTAGE VS. CHANNEL TEMPERATURE (TYPICAL)

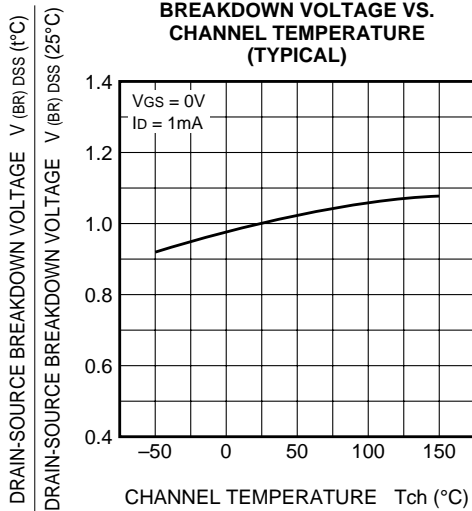

TRANSIENT THERMAL IMPEDANCE CHARACTERISTICS

