



SPX116

Low Dropout Voltage Three Terminal Regulator

FEATURES

- 3.3V and 3.5V Versions
- Output Current in Excess of 100 mA
- Input-Output Differential of 0.3V at 100mA
- Mirror-Image Insertion Protection
- Internal Thermal Protection
- Available in TO-92 and SOT-89 Packages
- Reverse Battery, Internal Short Circuit, Reverse Transient and Load Dump Protection
- Output Accuracy at 25°C
- Direct Replacement for TK116

APPLICATION

- Portable Instrumentation
- Cordless Telephones
- Radio Control Systems
- Battery Powered Systems
- Portable Consumer Devices
- Pagers
- Cellular Phones
- Low Voltage Systems

PRODUCT DESCRIPTION

The SPX116 is a low power, positive voltage regulator. This device is an excellent choice for use in battery-powered applications such as cordless telephones, radio control systems, and portable computers. The SPX116 features offers very low quiescent currents (0.4 mA), and very low drop output voltage (50 mV at light load and 300 mV at 100 mA). The SPX116 is a direct replacement for the TK116. The SPX116 is offered in a 3-pin TO-92 and SOT-89 package.

TYPICAL APPLICATION

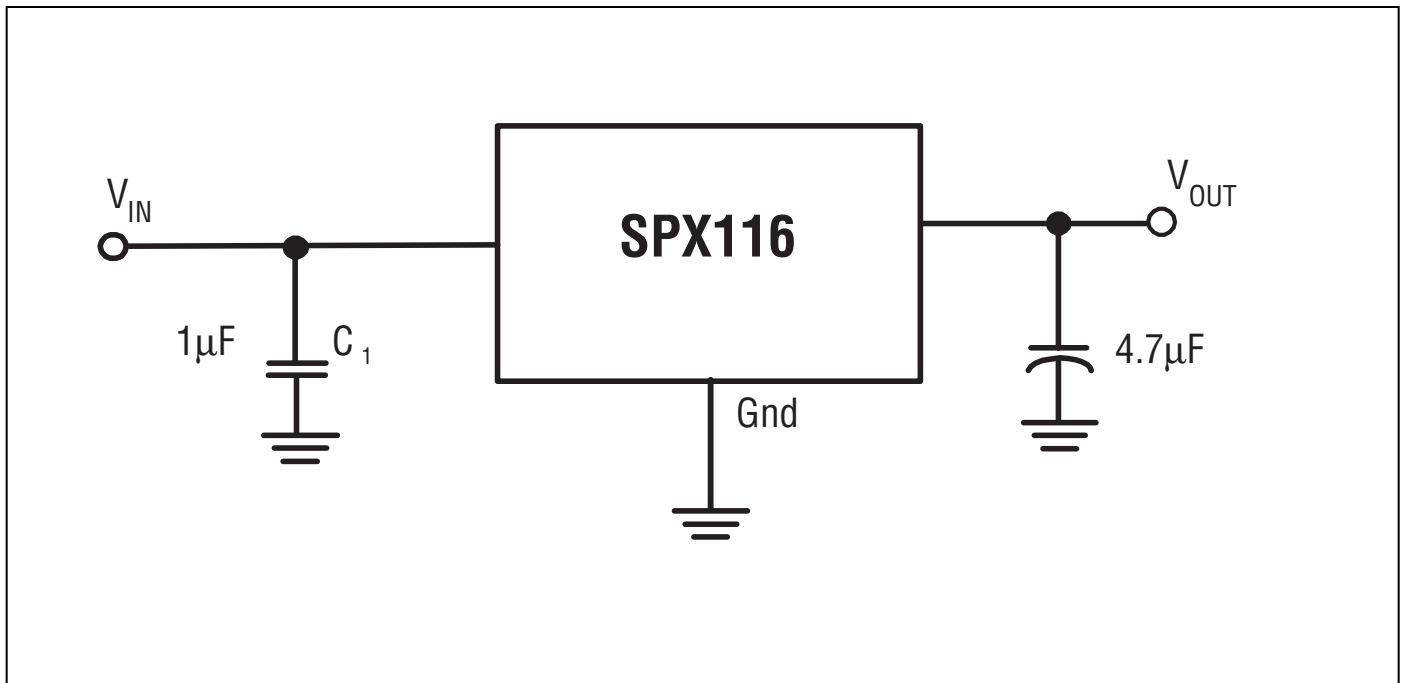

ABSOLUTE MAXIMUM RATINGS

Power Dissipation (note 3)	Internally limited
Lead Temp. (soldering, 5 Seconds)	260°C
Storage Temperature Range	-65°C to +150°C
Maximum Junction Temperature	+125°C
Input Supply Voltage Range	-0.3 to +30V
ESD Rating (note 4)	2kV

RECOMMENDED OPERATING CONDITIONS

Input Supply Voltage Range	3.0 to 26V
Maximum Load Current	180mA
Operating Junction Temperature Range	-40°C to 125°C
TO-92 Θ_{JA}	160°C/W
SOT-89 Θ_{JA}	110°C/W

ELECTRICAL CHARACTERISTICS at $V_{IN}=6V$, $T_A = 25^\circ C$, $I_O = 1mA$, $C_{OUT} = 4.7\mu F$, unless otherwise specified.

(Note 1)

Parameter	Conditions	SPX116			Units
		Min	Typ	Max	
Output Voltage (note 2)	$4V < V_{IN} < 14V$, $I_O = 10 mA$.	3.201	3.300	3.399	V
Output Voltage (note 2)	$4V < V_{IN} < 14V$, $I_O = 10 mA$.	3.395	3.500	3.605	V
Line Regulation	$9V < V_{IN} < 14V$ $4.5V < V_{IN} < 14V$,		4.0		mV
Load Regulation	$10 mA < I_O < 100 mA$		14		mV
Dropout Voltage	$I_O=10 mA$ $I_O=100 mA$		0.05 0.3		V
Quiescent Current	$I_O < 10 mA$, $4.5V < V_{IN} < 26V$ $I_O = 100 mA$, $V_{IN} = 14V$,		0.4 15		mA
Output Noise Voltage	10Hz-100kHz, $C_{OUT}=100\mu F$		500		μV_{rms}
Ripple Rejection	$F_O = 120Hz$		80		dB
Maximum Operational Input Voltage		14			V
Current Limit		150	400		mA

Note 1: See TYPICAL APPLICATIONS notes to ensure constant junction temperature, low duty cycle pulse testing used.

Note 2: All limits are at 25°C; operation is guaranteed over the full operating junction temperature range of -40°C to +125°C.

Note 3: The maximum power dissipation is a function of maximum junction temperature, total thermal resistance, and ambient temperature.

Note 4: Human body model, 100 pF discharged through 1.5 k Ω .

TYPICAL CHARACTERISTICS

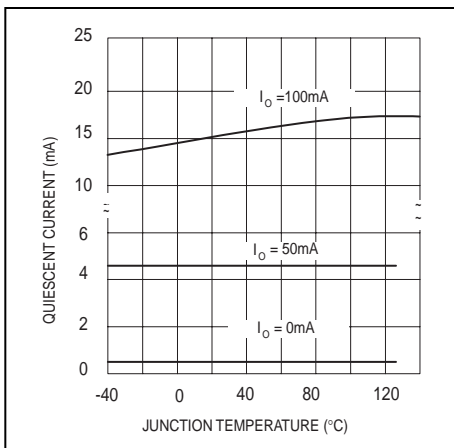

Figure 1. Quiescent Current

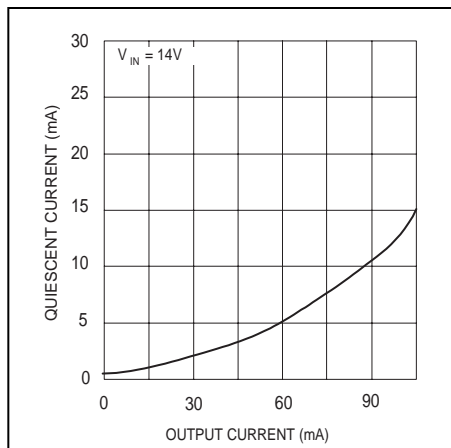

Figure 2. Quiescent Current

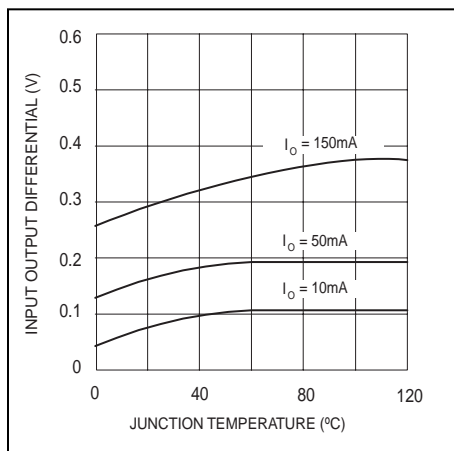

Figure 3. Dropout Voltage

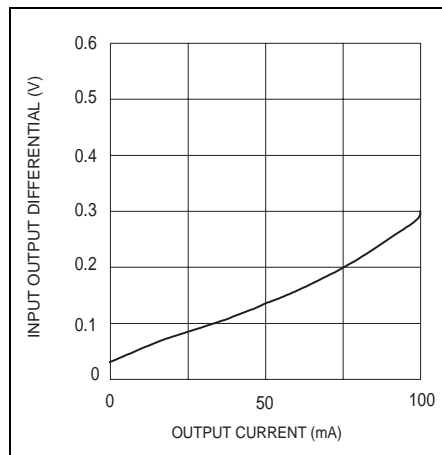

Figure 4. Dropout Voltage

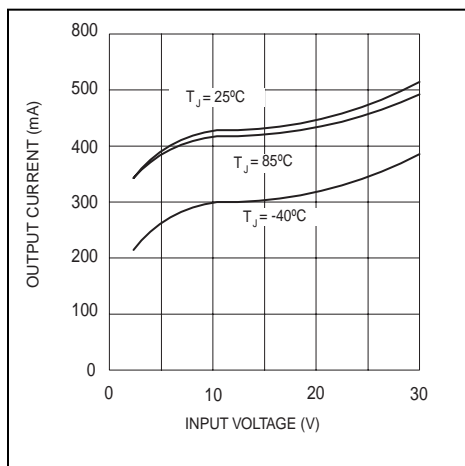

Figure 5. Peak Output Current

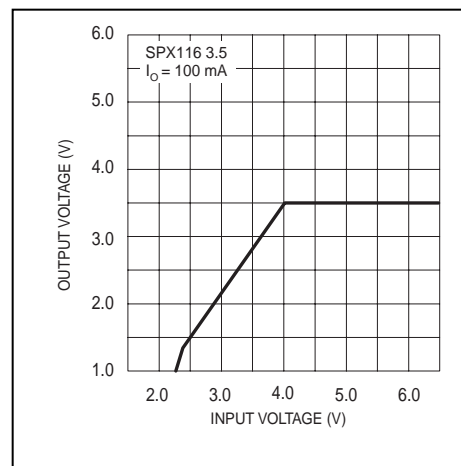

Figure 6. Low Voltage Behavior

TYPICAL CHARACTERISTICS Continued

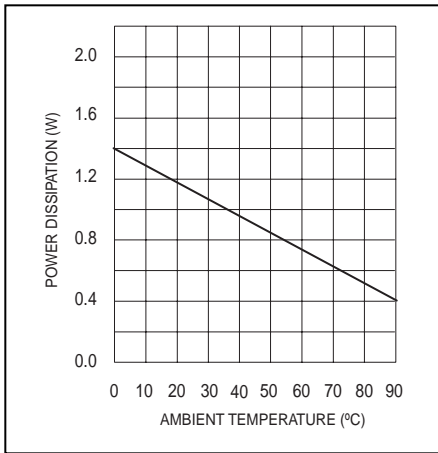

Figure 7. Maximum Power Dissipation (SOT89)

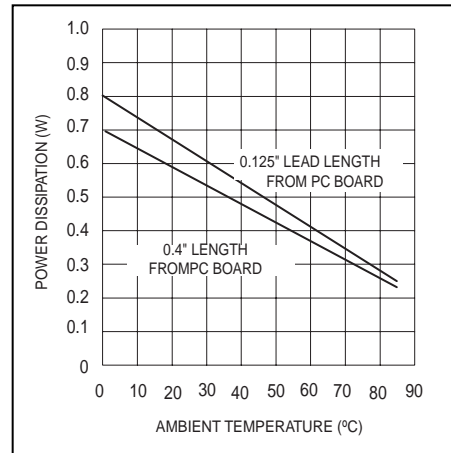

Figure 8. Maximum Power Dissipation (TO-92)

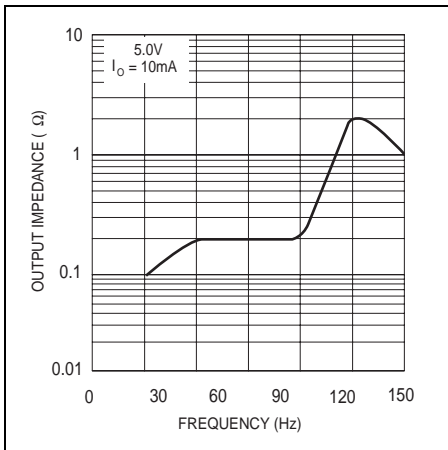

Figure 9. Output Impedance

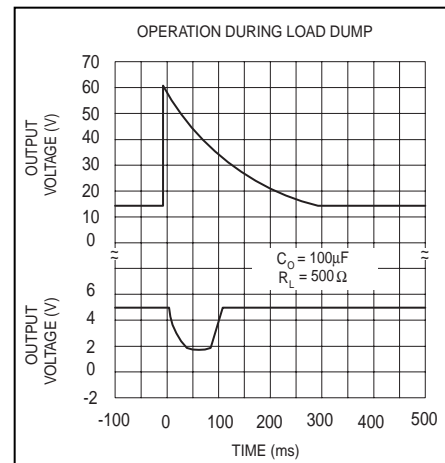

Figure 10. Operation During Load Dump

APPLICATION INFORMATION

The SPX116 requires an output capacitor for device stability. The value required varies greatly depending upon the application circuit and other factors. The high frequency characteristics of electrolytic capacitors depend greatly on the type and also on the manufacturer. Sometimes only bench testing is the only means to determine the proper capacitor type and value. Stability can be obtained with a tantalum or ceramic capacitor value of 4.7 μ F or greater.

Another critical point of electrolytic characteristics is its performance over temperature. The SPX116 is designed to operate starting at -40°C which may not be true in the case of electrolytic. Higher temperatures generally no problem. The electrolytic type in aluminum will freeze around -30°C. This could cause an oscillation at output of regulator. At a lower temperature requirement by many applications the capacitor should maintain its performance. So as a result, for an application which regulator junction temperature does not exceed 25°C, the output capacitor can be reduced by the

factor of two over the value needed for the entire temperature range.

In most applications the SPX116 is operating at few milliamps. In these applications the output capacitance can be further reduced. For example, when the regulator is running at 10mA output current the output capacitance value is half compared to the same regulator that is running at 100mA. The value decreases with higher output voltages, since the internal loop gain is reduced.

The worst case occurs at the lower temperature and maximum operating currents, the entire circuit and the electrolytic, should be cooled down to the minimum temperature. The minimum of 0.6 volts required at the input of regulator above the output to keep the power dissipation and die heating to its minimum. After the value for the capacitor has been determined for actual use, the value should be doubled.

PACKAGE PINOUTS

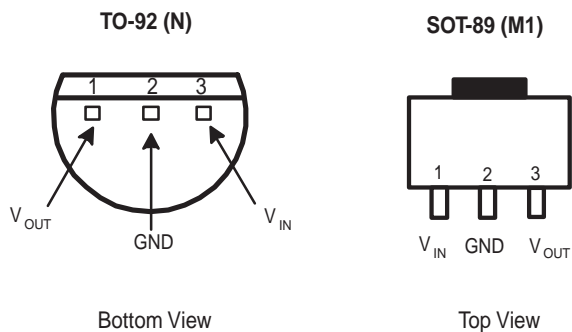

ORDERING INFORMATION

Part Number	Accuracy	Output Voltage	Package
SPX116M1-3.3	3%	3.3V	3 lead SOT-89
SPX116M1-3.5	3%	3.5V	3 lead SOT-89
SPX116N-3.3	3%	3.3V	3 lead TO-92
SPX116N-3.5	3%	3.5V	3 lead TO-92



SIGNAL PROCESSING EXCELLENCE

Sipex Corporation

Headquarters and Main Offices:

22 Linnell Circle
 Billerica, MA 01821
 TEL: (978) 667-8700
 FAX: (978) 670-9001
 e-mail: sales@sipex.com

233 South Hillview Drive
 Milpitas, CA 95035
 TEL: (408) 935-7600
 FAX: (408) 934-7500

Sipex Corporation reserves the right to make changes to any products described herein. Sipex does not assume any liability arising out of the application or use of any product or circuit described hereing; neither does it convey any license under its patent rights nor the rights of others.