

# TC4SU69F

## INVERTER GATE

The TC4SU69F is single inverter. Therefore, this is suitable for the applications of C, R oscillator circuits, crystal oscillator circuits and linear amplifiers in addition to its application as inverters.

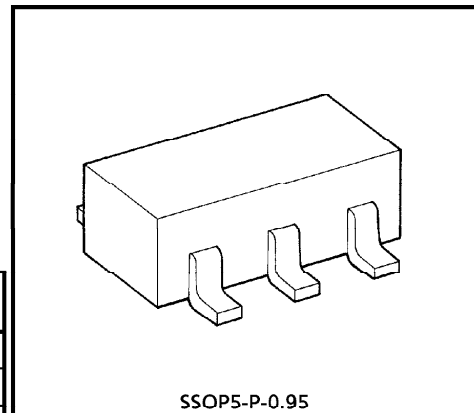

SSOP5-P-0.95  
Weight : 0.016g (Typ.)

### MAXIMUM RATINGS (Ta = 25°C)

CHARACTERISTIC	SYMBOL	RATING	UNIT
DC Supply Voltage	V <sub>DD</sub>	V <sub>SS</sub> - 0.5 ~ V <sub>SS</sub> + 20	V
Input Voltage	V <sub>IN</sub>	V <sub>SS</sub> - 0.5 ~ V <sub>DD</sub> + 0.5	V
Output Voltage	V <sub>OUT</sub>	V <sub>SS</sub> - 0.5 ~ V <sub>DD</sub> + 0.5	V
DC Input Current	I <sub>IN</sub>	± 10	mA
Power Dissipation	P <sub>D</sub>	200	mW
Operating Temperature Range	T <sub>opr</sub>	- 40 ~ 85	°C
Storage Temperature Range	T <sub>stg</sub>	- 65 ~ 150	°C
Lead Temperature (10s)	T <sub>L</sub>	260	°C

### LOGIC DIAGRAM

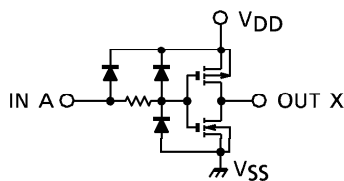

### PIN CONFIGURATION (TOP VIEW)

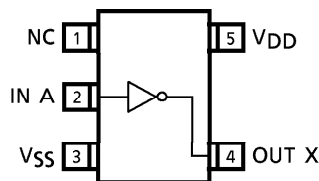

### Marking

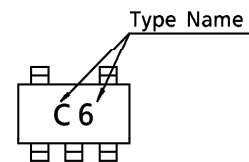

961001EBA2

● TOSHIBA is continually working to improve the quality and the reliability of its products. Nevertheless, semiconductor devices in general can malfunction or fail due to their inherent electrical sensitivity and vulnerability to physical stress. It is the responsibility of the buyer, when utilizing TOSHIBA products, to observe standards of safety, and to avoid situations in which a malfunction or failure of a TOSHIBA product could cause loss of human life, bodily injury or damage to property. In developing your designs, please ensure that TOSHIBA products are used within specified operating ranges as set forth in the most recent products specifications. Also, please keep in mind the precautions and conditions set forth in the TOSHIBA Semiconductor Reliability Handbook.

**RECOMMENDED OPERATING CONDITIONS (V<sub>SS</sub> = 0V)**

CHARACTERISTIC	SYMBOL		MIN.	TYP.	MAX.	UNIT
DC Supply Voltage	V <sub>DD</sub>	—	3	—	18	V
Input Voltage	V <sub>IN</sub>	—	0	—	V <sub>DD</sub>	V

**STATIC ELECTRICAL CHARACTERISTICS (V<sub>SS</sub> = 0V)**

CHARACTERISTIC	SYM-BOL	TEST CONDITION	V <sub>DD</sub> (V)	- 40°C		25°C			85°C		UNIT	
				MIN.	MAX.	MIN.	TYP.	MAX.	MIN.	MAX.		
High-Level Output Voltage	V <sub>OH</sub>	I <sub>OUT</sub>   < 1μA V <sub>IN</sub> = V <sub>SS</sub>	5	4.95	—	4.95	5.00	—	4.95	—	V	
			10	9.95	—	9.95	10.00	—	9.95	—		
			15	14.95	—	14.95	15.00	—	14.95	—		
Low-Level Output Voltage	V <sub>OL</sub>	I <sub>OUT</sub>   < 1μA V <sub>IN</sub> = V <sub>DD</sub>	5	—	0.05	—	0.00	0.05	—	0.05	V	
			10	—	0.05	—	0.00	0.05	—	0.05		
			15	—	0.05	—	0.00	0.05	—	0.05		
Output High Current	I <sub>OH</sub>	V <sub>OH</sub> = 4.6V V <sub>OH</sub> = 2.5V V <sub>OH</sub> = 9.5V V <sub>OH</sub> = 13.5V V <sub>IN</sub> = V <sub>SS</sub>	5	-0.61	—	-0.51	-1.0	—	-0.42	—	mA	
			5	-2.5	—	-2.1	-4.0	—	-1.7	—		
			10	-1.5	—	-1.3	-2.2	—	-1.1	—		
			15	-4.0	—	-3.4	-9.0	—	-2.8	—		
Output Low Current	I <sub>OL</sub>	V <sub>OL</sub> = 0.4V V <sub>OL</sub> = 0.5V V <sub>OL</sub> = 1.5V V <sub>IN</sub> = V <sub>DD</sub>	5	0.61	—	0.51	1.2	—	0.42	—	mA	
			10	1.5	—	1.3	3.2	—	1.1	—		
			15	4.0	—	3.4	12.0	—	2.8	—		
			—	—	—	—	—	—	—	—		
Input High Voltage	V <sub>IH</sub>	V <sub>OUT</sub> = 0.5V V <sub>OUT</sub> = 1.0V V <sub>OUT</sub> = 1.5V  I <sub>OUT</sub>   < 1μA	5	4.0	—	4.0	—	—	4.0	—	V	
			10	8.0	—	8.0	—	—	8.0	—		
			15	12.0	—	12.0	—	—	12.0	—		
			—	—	—	—	—	—	—	—		
Input Low Voltage	V <sub>IL</sub>	V <sub>OUT</sub> = 4.5V V <sub>OUT</sub> = 9.0V V <sub>OUT</sub> = 13.5V  I <sub>OUT</sub>   < 1μA	5	—	1.0	—	—	1.0	—	1.0	V	
			10	—	2.0	—	—	2.0	—	2.0		
			15	—	3.0	—	—	3.0	—	3.0		
			—	—	—	—	—	—	—	—		
Input Current	H Level	I <sub>IH</sub>	V <sub>IH</sub> = 18V	18	—	0.1	—	10 <sup>-5</sup>	0.1	—	1.0	μA
	L Level	I <sub>IL</sub>	V <sub>IL</sub> = 0V	18	—	-0.1	—	-10 <sup>-5</sup>	-0.1	—	-1.0	
Quiescent Device Current	I <sub>DD</sub>	V <sub>IN</sub> = V <sub>SS</sub> , V <sub>DD</sub>	5	—	0.25	—	0.001	0.25	—	7.5	μA	
			10	—	0.5	—	0.001	0.5	—	15		
			15	—	1.0	—	0.002	1.0	—	30		

961001EBA2'

- The products described in this document are subject to foreign exchange and foreign trade control laws.
- The information contained herein is presented only as a guide for the applications of our products. No responsibility is assumed by TOSHIBA CORPORATION for any infringements of intellectual property or other rights of the third parties which may result from its use. No license is granted by implication or otherwise under any intellectual property or other rights of TOSHIBA CORPORATION or others.
- The information contained herein is subject to change without notice.

**DYNAMIC ELECTRICAL CHARACTERISTICS** (Ta = 25°C, VSS = 0V, CL = 50pF)

CHARACTERISTIC	SYMBOL	TEST CONDITION	VDD (V)	MIN.	TYP.	MAX.	UNIT
Output Transition Time (Low to High)	t <sub>TLH</sub>	—	5	—	70	200	ns
			10	—	35	100	
			15	—	30	80	
Output Transition Time (High to Low)	t <sub>THL</sub>	—	5	—	70	200	ns
			10	—	35	100	
			15	—	30	80	
Propagation Delay Time	t <sub>pLH</sub>	—	5	—	55	110	ns
			10	—	30	60	
			15	—	25	50	
Propagation Delay Time	t <sub>pHL</sub>	—	5	—	55	110	ns
			10	—	30	60	
			15	—	25	50	
Input Capacitance	C <sub>IN</sub>	—	—	7.5	15	pF	

**CIRCUIT AND WAVEFORM FOR MEASUREMENT OF DYNAMIC CHARACTERISTICS**

TEST CIRCUIT

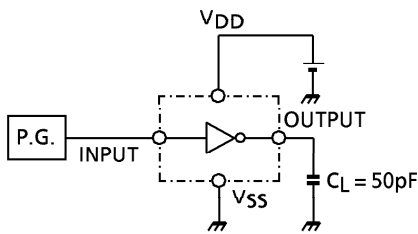

WAVEFORM

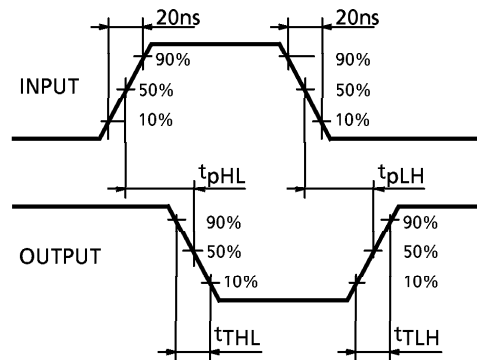

OUTLINE DRAWING  
SSOP5-P-0.95

Unit : mm

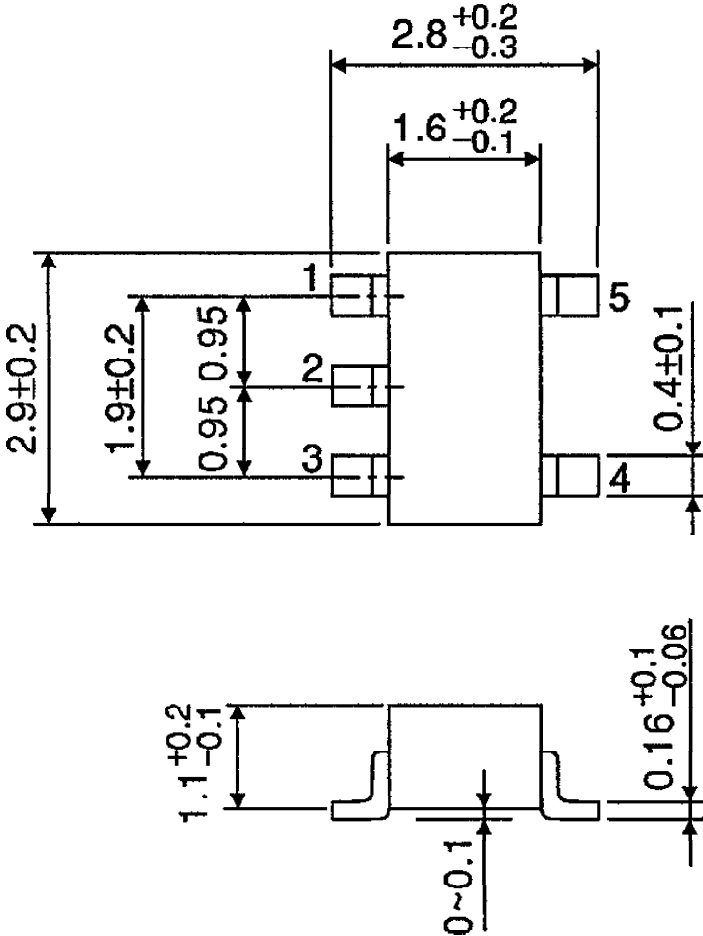

Weight : 0.016g (Typ.)