

DESCRIPTION The 2SC2688 is designed for use in Color TV chroma output circuits.

- FEATURES**
- High Electrostatic-Discharge-Resistance. (E-B reverse bias, $C = 2300 \text{ pF}$) ESDR : TYP. 1 000 V
 - Low C_{re} , High f_T
 $C_{re} \leq 3.0 \text{ pF}$ ($V_{CB} = 30 \text{ V}$)
 $f_T \geq 50 \text{ MHz}$ ($V_{CE} = 30 \text{ V}$, $I_E = -10 \text{ mA}$)

ABSOLUTE MAXIMUM RATINGS

Maximum Temperatures	
Storage Temperature	-55 to +150 °C
Junction Temperature	150 °C Maximum
Maximum Power Dissipations	
Total Power Dissipation ($T_a = 25 \text{ °C}$)	1.25 W
Total Power Dissipation ($T_c = 25 \text{ °C}$)	10 W
Maximum Voltages and Current ($T_a = 25 \text{ °C}$)	
V_{CBO} Collector to Base Voltage	300 V
V_{CEO} Collector to Emitter Voltage	300 V
V_{EBO} Emitter to Base Voltage	5.0 V
I_C Collector Current	200 mA

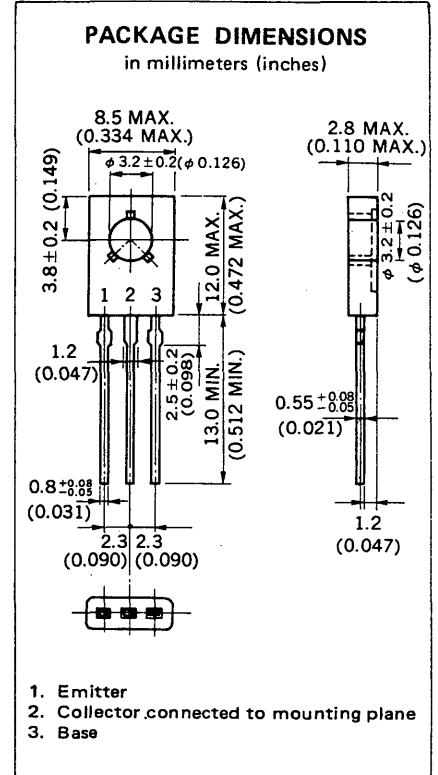

ELECTRICAL CHARACTERISTICS ($T_a = 25 \text{ °C}$)

SYMBOL	CHARACTERISTIC	MIN.	TYP.	MAX.	UNIT	TEST CONDITIONS
h_{FE}	DC Current Gain	40	80	250		$V_{CE} = 10 \text{ V}$, $I_C = 10 \text{ mA}^*$
f_T	Gain Bandwidth Product	50	80		MHz	$V_{CE} = 30 \text{ V}$, $I_E = -10 \text{ mA}$
C_{re}	Feedback Capacitance			3.0	pF	$V_{CB} = 30 \text{ V}$, $I_E = 0$, $f = 1.0 \text{ MHz}$
I_{CBO}	Collector Cutoff Current			100	nA	$V_{CB} = 200 \text{ V}$, $I_E = 0$
I_{EBO}	Emitter Cutoff Current			100	nA	$V_{EB} = 5.0 \text{ V}$, $I_C = 0$
$V_{CE(sat)}$	Collector Saturation Voltage			1.5	V	$I_C = 50 \text{ mA}$, $I_B = 5.0 \text{ mA}$

*Pulsed $PW \leq 350 \mu\text{s}$, Duty Cycle $\leq 2 \%$

Classification of h_{FE}

Rank	N	M	L	K
Range	40 to 80	60 to 120	100 to 200	160 to 250

Test Conditions : $V_{CE} = 10 \text{ V}$, $I_C = 10 \text{ mA}$

TYPICAL CHARACTERISTICS ($T_a = 25^\circ\text{C}$)

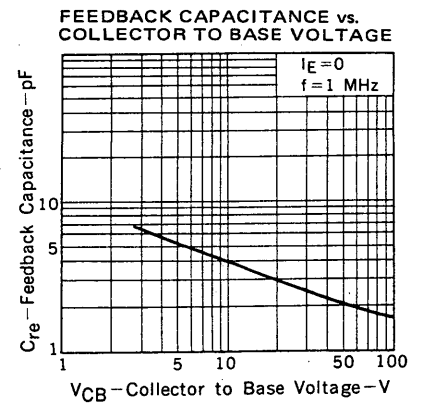
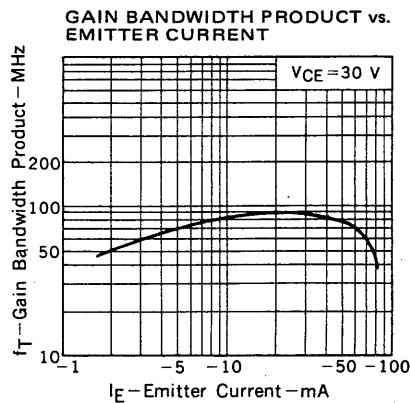
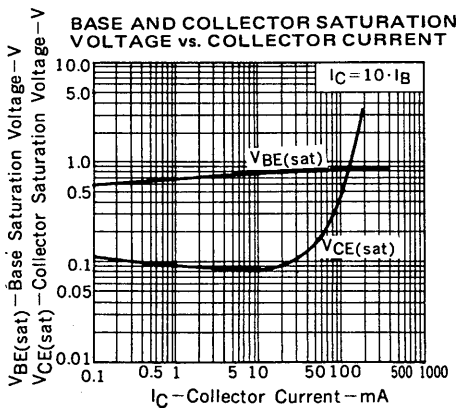
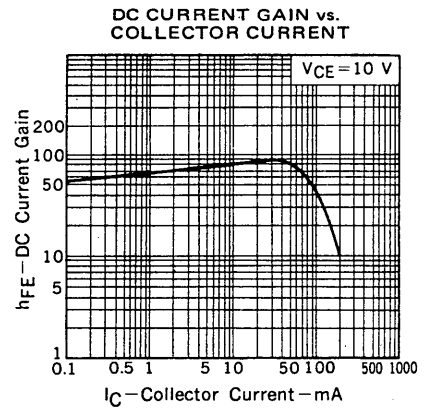
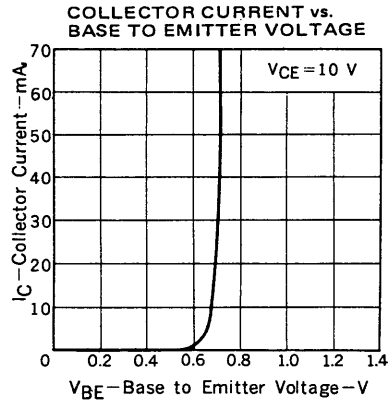
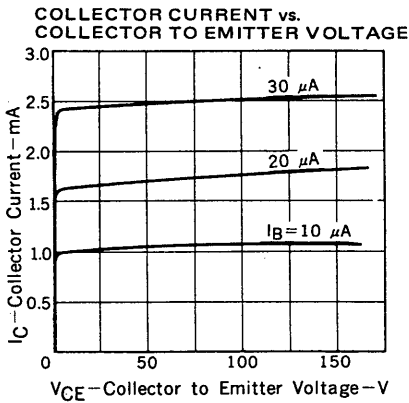
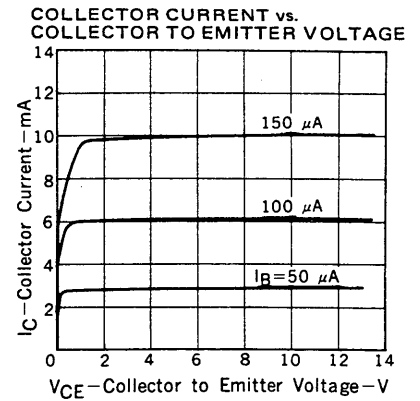
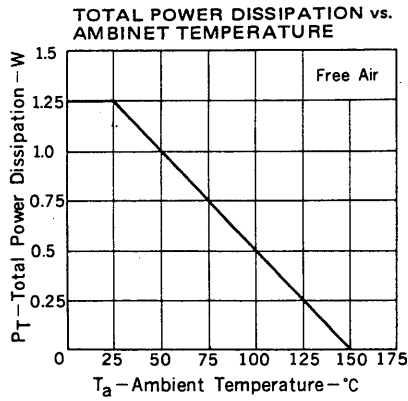
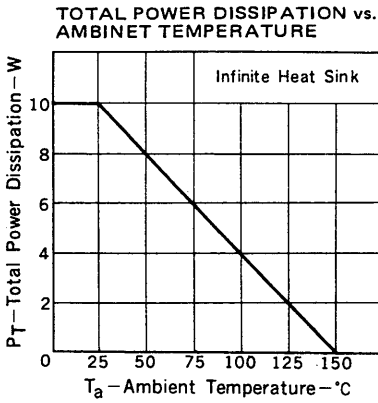

BURNOUT TEST CIRCUIT BY DISCHARGE OF CAPACITOR

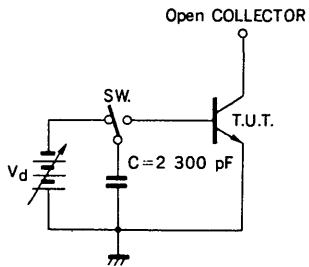

TEST CONDITION

- 1) E-B reverse bias
- 2) $C = 2300 \text{ pF}$
- 3) Apply one shot pulse to T.U.T. (Transistor Under the Test) by SW.

JUDGEMENT

REJECT; BV_{EBO} waveform defect
As a result if T.U.T. is not rejected, apply higher voltage to capacitor and test again.