

IGBT MODULE (S series) 1200V / 35A / PIM



■ Features

- Low $V_{CE(sat)}$
- Compact package
- P.C. board mount
- Converter diode bridge, Dynamic brake circuit

■ Applications

- Inverter for motor drive
- AC and DC servo drive amplifier
- Uninterruptible power supply

■ Maximum ratings and characteristics

● Absolute maximum ratings ($T_c=25^\circ\text{C}$ unless without specified)

Item	Symbol	Condition	Rating	Unit		
Inverter	Collector-Emitter voltage	V_{CES}	1200	V		
	Gate-Emitter voltage	V_{GES}	± 20	V		
	Collector current	I_C	Continuous	$T_c=25^\circ\text{C}$	50	A
				$T_c=80^\circ\text{C}$	35	
		I_{CP}	1ms	$T_c=25^\circ\text{C}$	100	A
				$T_c=80^\circ\text{C}$	70	
	$-I_C$		35	A		
Collector power dissipation	P_C	1 device	240	W		
Brake	Collector-Emitter voltage	V_{CES}	1200	V		
	Gate-Emitter voltage	V_{GES}	± 20	V		
	Collector current	I_C	Continuous	$T_c=25^\circ\text{C}$	35	A
				$T_c=80^\circ\text{C}$	25	
		I_{CP}	1ms	$T_c=25^\circ\text{C}$	70	A
				$T_c=80^\circ\text{C}$	50	
Collector power dissipation	P_C	1 device	180	W		
Repetitive peak reverse voltage	V_{RRM}		1200	V		
Converter	Repetitive peak reverse voltage	V_{RRM}	1600	V		
	Average output current	I_O	50Hz/60Hz sine wave	35	A	
	Surge current (Non-Repetitive)	I_{FSM}	$T_j=150^\circ\text{C}$, 10ms	360	A	
	I^2t (Non-Repetitive)	I^2t	half sine wave	648	A^2s	
Operating junction temperature	T_j		+150	$^\circ\text{C}$		
Storage temperature	T_{stg}		-40 to +125	$^\circ\text{C}$		
Isolation voltage	between terminal and copper base *2	V_{iso}	AC : 1 minute	AC 2500	V	
				AC 2500		
Mounting screw torque			3.5 *1	N·m		

*1 Recommendable value : 2.5 to 3.5 N·m (M5)

*2 All terminals should be connected together when isolation test will be done.

*3 Terminal 8 and 9 should be connected together. Terminal 1 to 7 and 10 to 24 should be connected together and shorted to copper base.

● Electrical characteristics (Tj=25°C unless otherwise specified)

Item	Symbol	Condition	Characteristics			Unit		
			Min.	Typ.	Max.			
Inverter	Zero gate voltage collector current	ICES	VCE=1200V, VGE=0V		1.0	mA		
	Gate-Emitter leakage current	IGES	VCE=0V, VGE=±20V		0.2	µA		
	Gate-Emitter threshold voltage	VGE(th)	VCE=20V, Ic=35mA		5.5	7.2	8.5	V
	Collector-Emitter saturation voltage	VCE(sat)	VGE=15V, Ic=35A	chip	2.1		V	
				terminal	2.25	2.7		
	Input capacitance	Cies	VGE=0V, VCE=10V, f=1MHz		4200		pF	
	Turn-on time	ton	VCC=600V		0.35	1.2	µs	
		tr	Ic=35A		0.25	0.6		
		tr(i)	VGE=±15V		0.1			
	Turn-off	toff	RG=33Ω		0.45	1.0		
tf				0.08	0.3			
Forward on voltage	VF	IF=35A	chip	2.3		V		
			terminal	2.45	3.3			
Reverse recovery time of FRD	trr	IF=35A			0.35	µs		
Brake	Zero gate voltage collector current	ICES	VCEs=1200V, VGE=0V		1.0	mA		
	Gate-Emitter leakage current	IGES	VCE=0V, VGE=±20V			0.2	µA	
	Collector-Emitter saturation voltage	VCE(sat)	Ic=25A, VGE=15V	chip	2.1		V	
				terminal	2.25	2.7		
	Turn-on time	ton	VCC=600V		0.35	1.2	µs	
		tr	Ic=25A		0.25	0.6		
	Turn-off time	toff	VGE=±15V		0.45	1.0		
		tf	RG=51Ω		0.08	0.3		
	Reverse current	Irrm	VR=1200V			1.0	mA	
	Forward on voltage	VFM	IF=35A	chip	1.1		V	
terminal				1.2	1.5			
Reverse current	Irrm	VR=1600V			1.0	mA		
Thermistor	Resistance	R	T=25°C		5000	Ω		
			T=100°C		465		495	520
	B value	B	T=25/50°C		3305	3375	3450	K

● Thermal resistance Characteristics

Item	Symbol	Condition	Characteristics			Unit
			Min.	Typ.	Max.	
Thermal resistance (1 device)	Rth(j-c)	Inverter IGBT			0.52	°C/W
		Inverter FWD			0.90	
		Brake IGBT			0.69	
		Converter Diode			0.75	
Contact thermal resistance *	Rth(c-f)	With thermal compound		0.05		

* This is the value which is defined mounting on the additional cooling fin with thermal compound

■ Equivalent Circuit Schematic

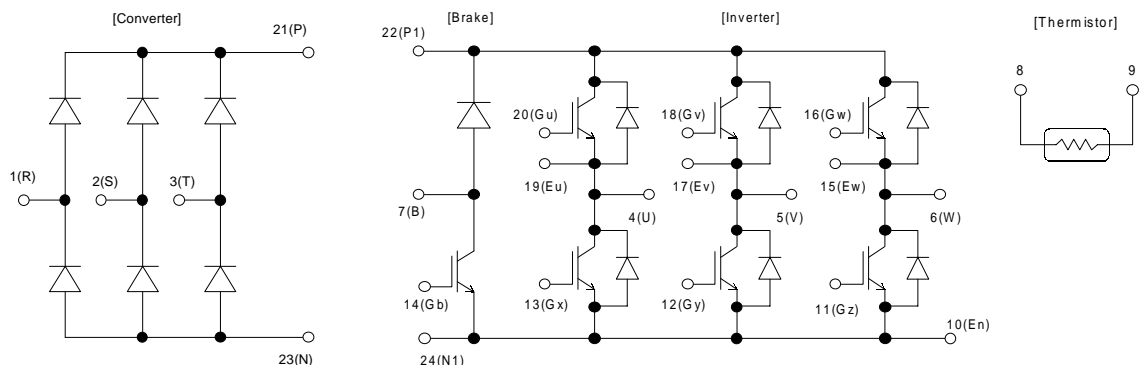

■ Characteristics (Representative)

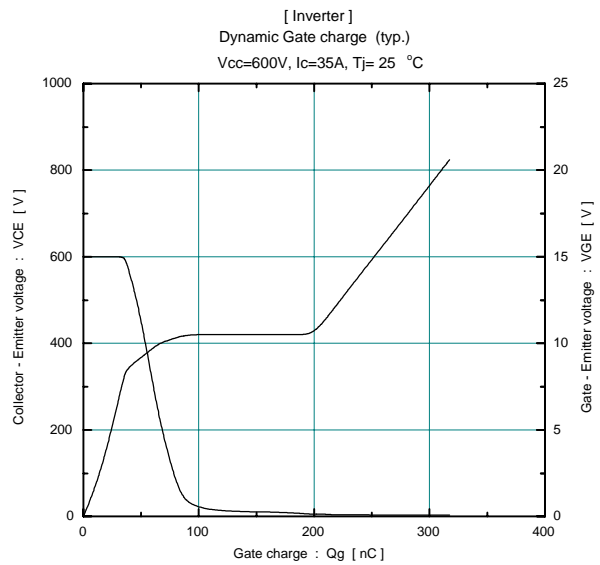
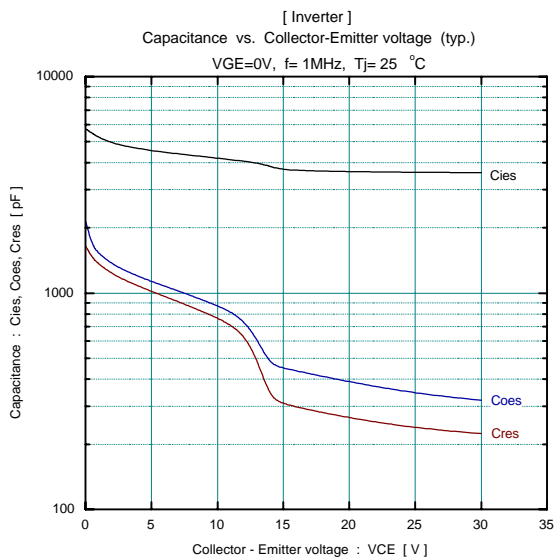
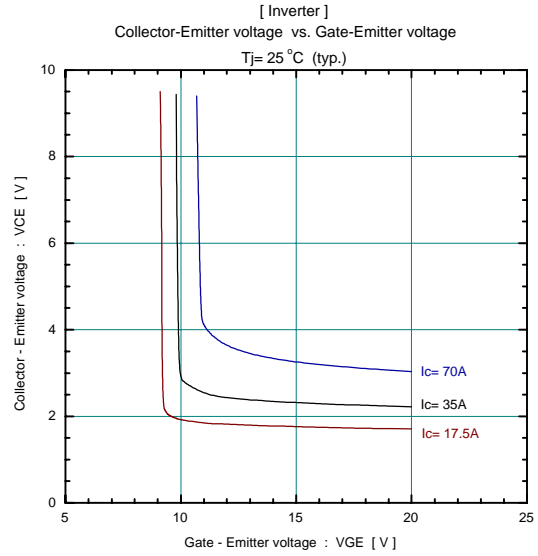
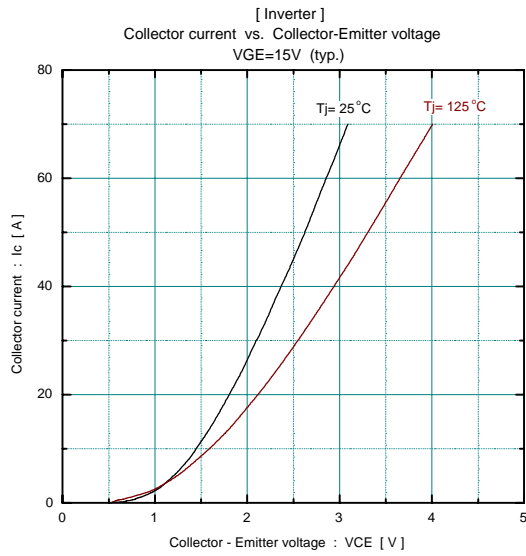
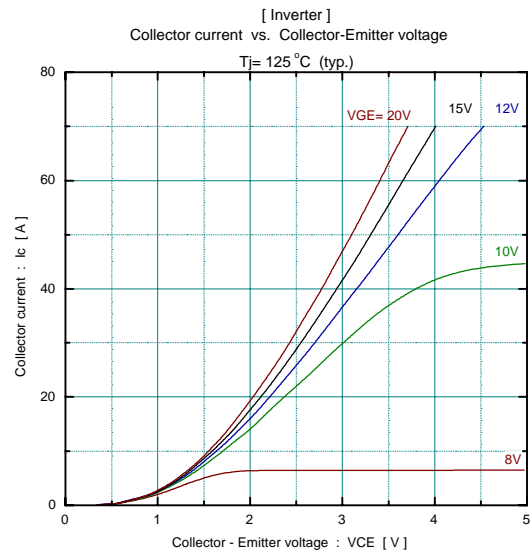
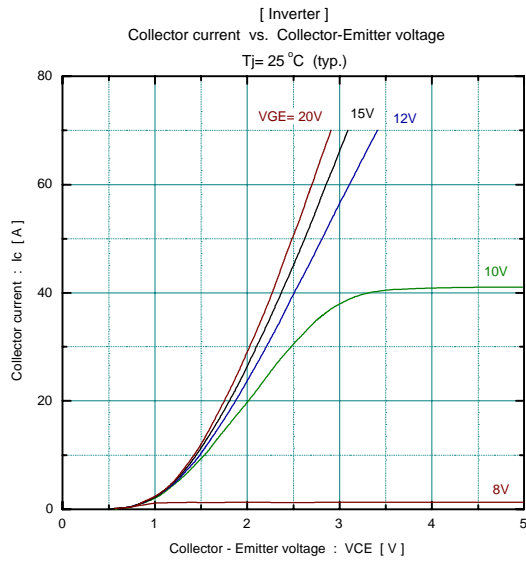

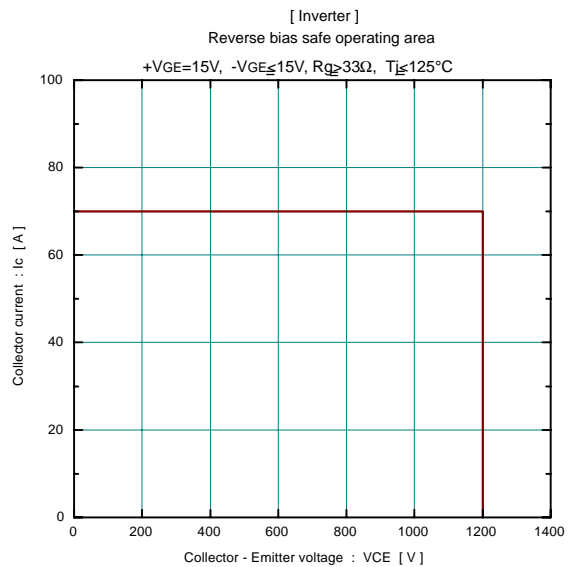
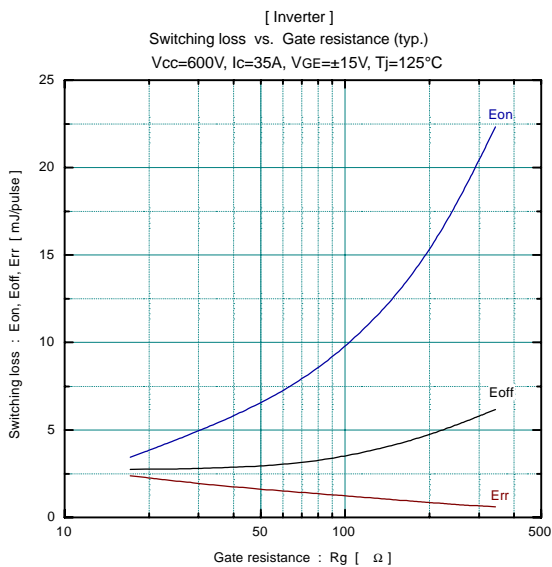
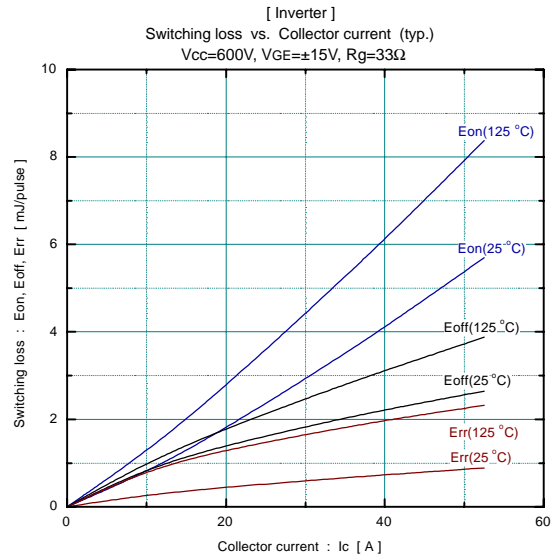
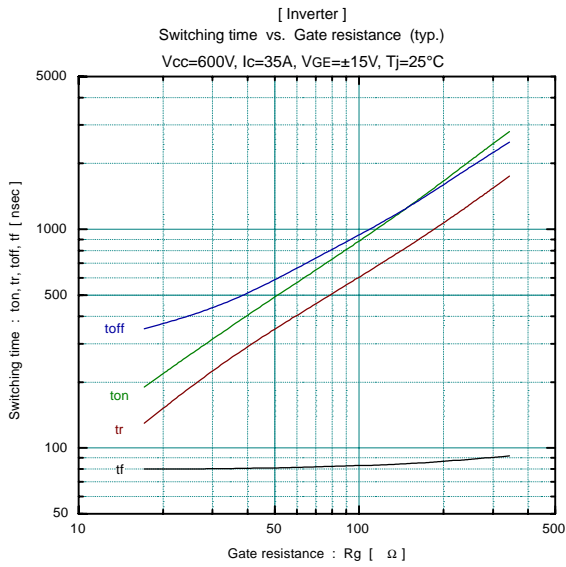
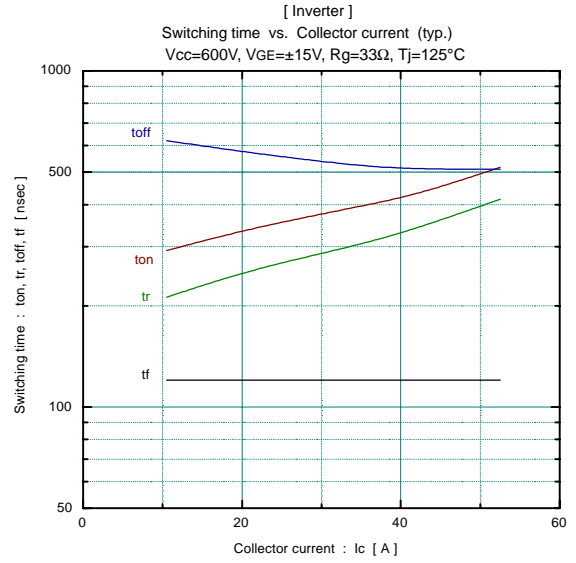
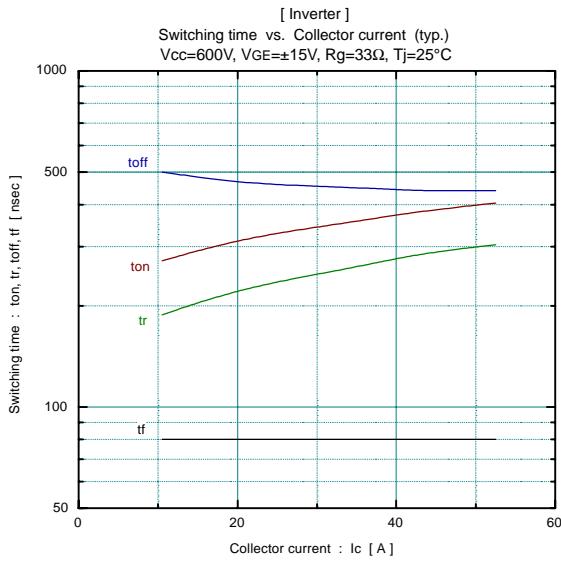

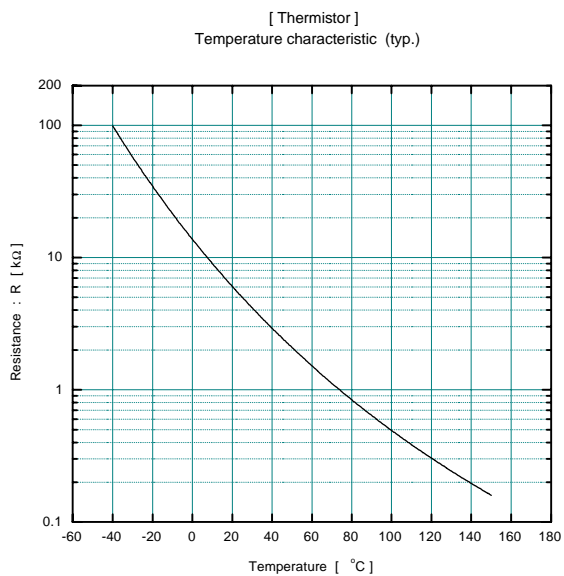
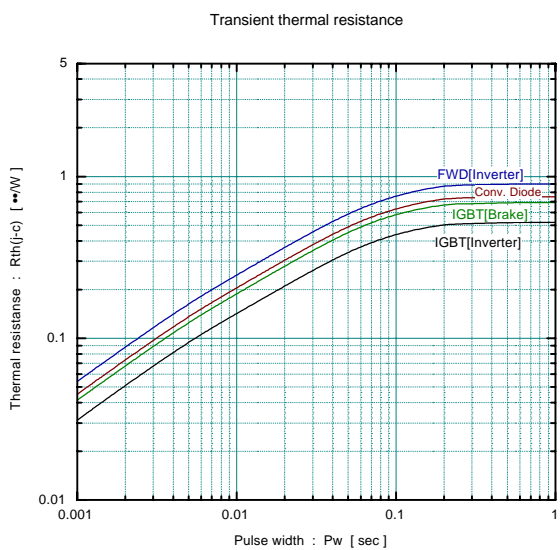
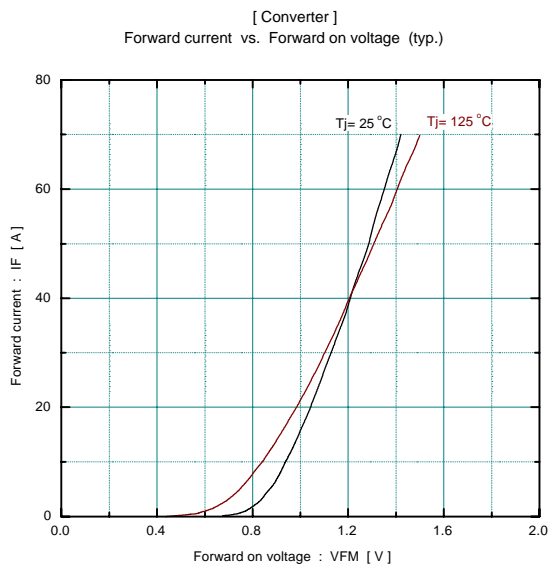
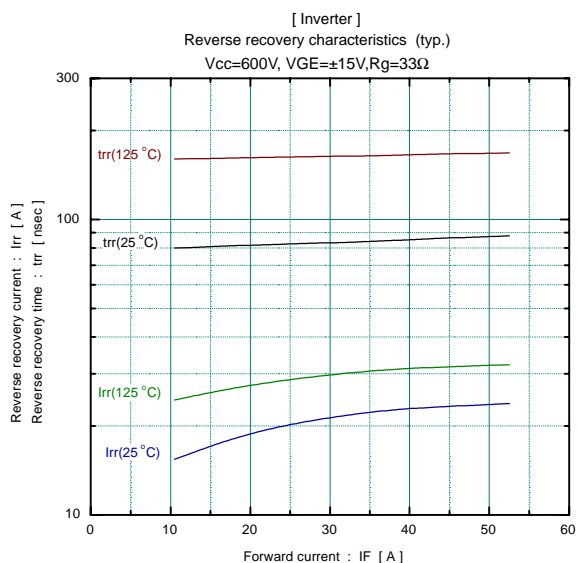
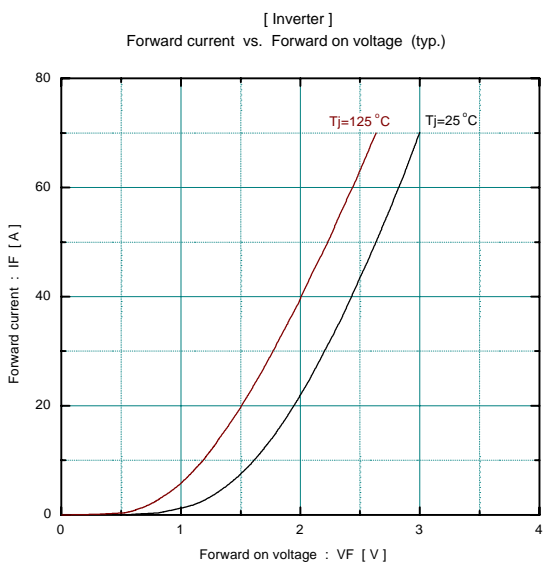

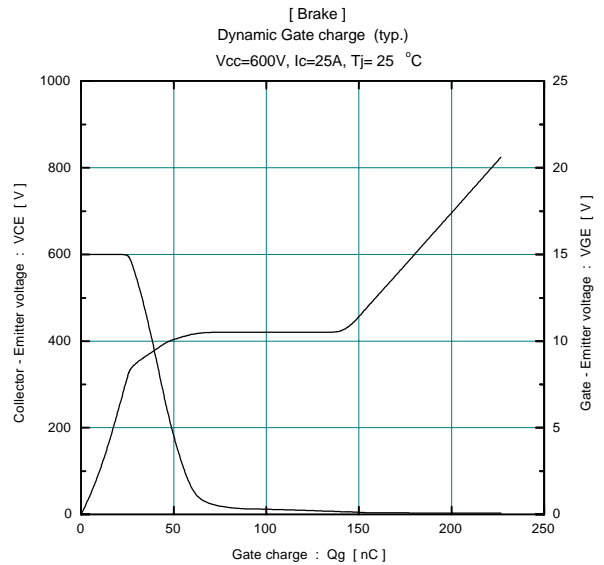
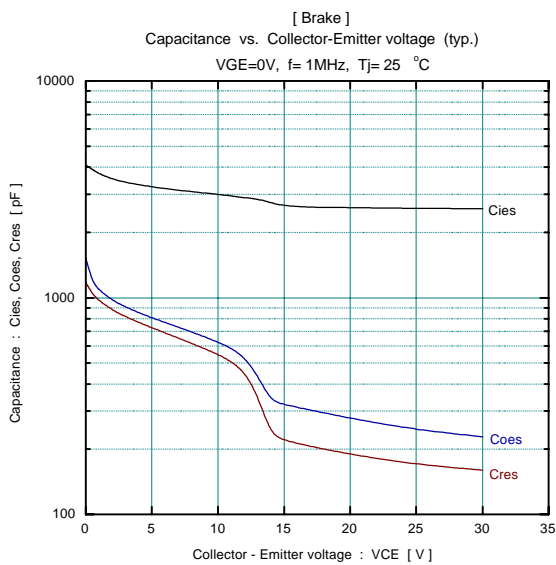
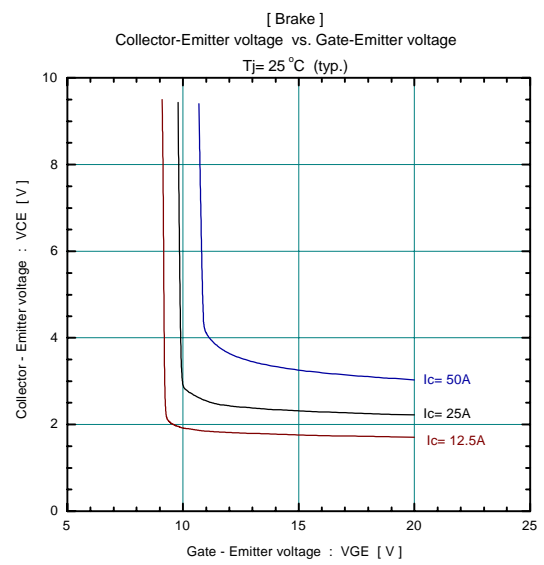
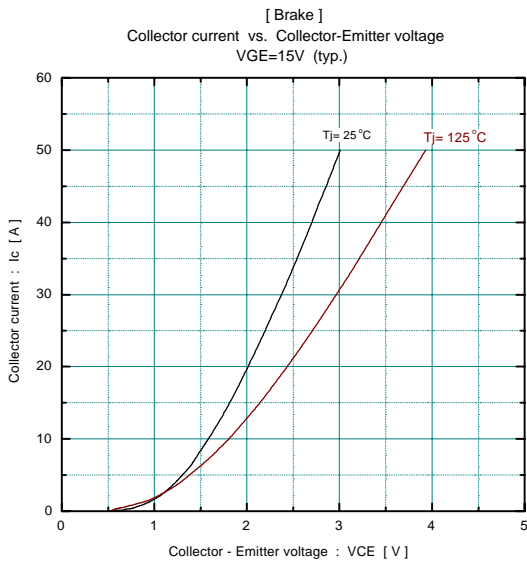
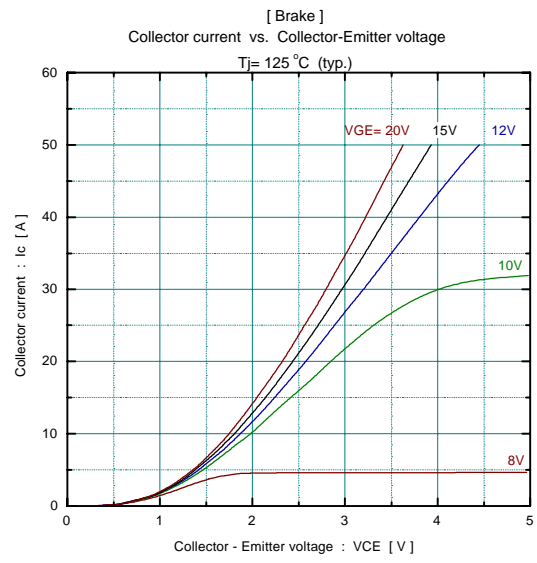
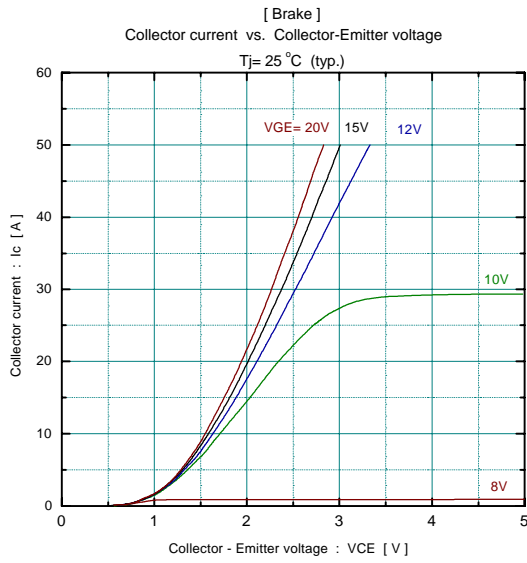

■ Outline Drawings, mm

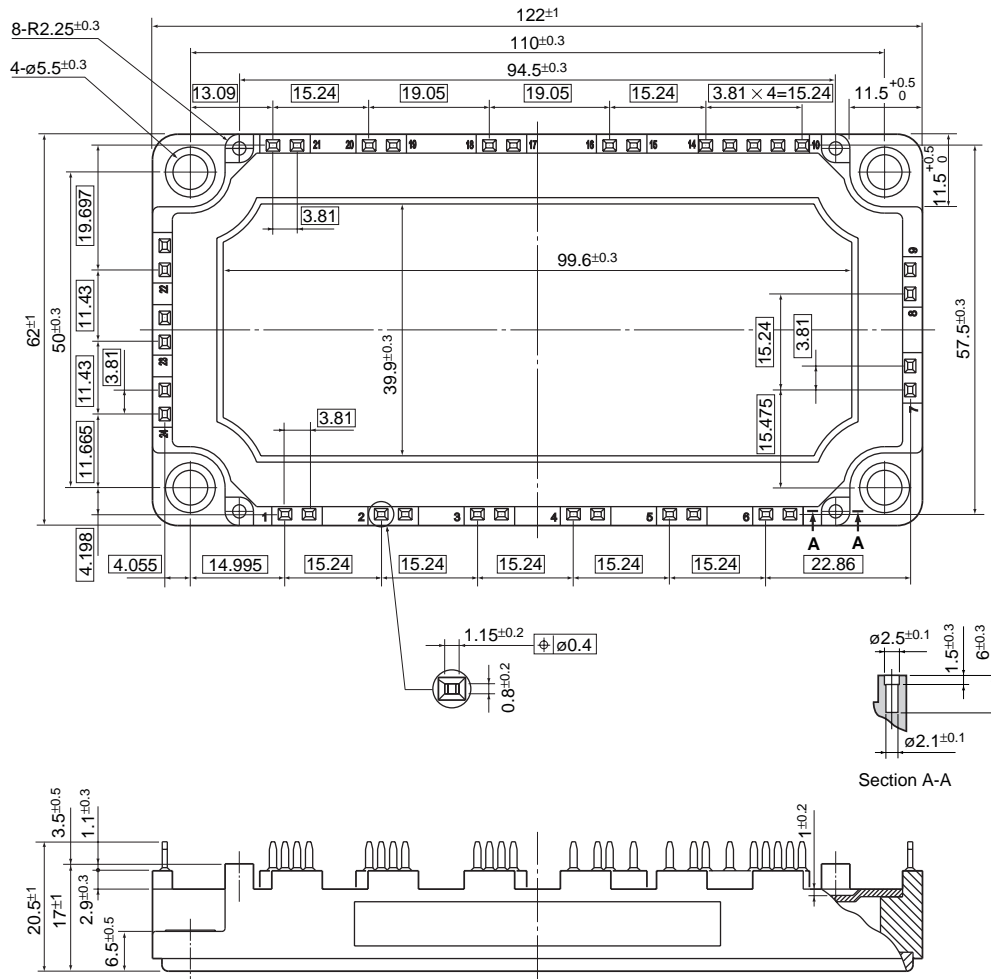

□ Shows theory dimensions