

FM-Tuner

TUA 4310X
TUA 4310XS

Preliminary Data

Bipolar IC

Features

- Double-balanced mixer
- High RF-input impedance
- Sym. and unsym. operation
- AGC-generation for PIN-Diodes and MOSFET's
- Strictly symmetrical RF-parts
- Decoupled counter output
- High supply voltage ripple rejection
- 2-pin oscillator
- First IF-amplifier adjustable gain
- Second IF-amplifier adjustable temperature coefficient

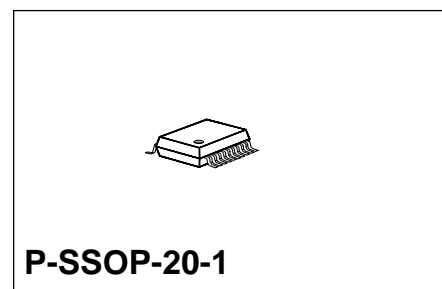
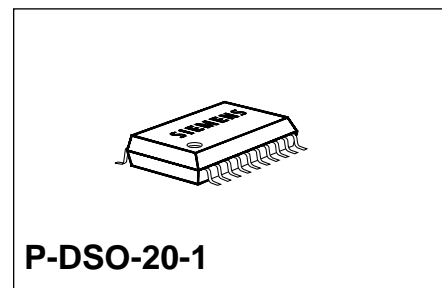

Type	Ordering Code	Package
TUA 4310X	Q67006-A5054	P-DSO-20-1 Tape and Reel
TUA 4310XS	Q67006-A5203	P-SSOP-20-1 Tape and Reel

Circuit Description

The TUA 4310X has been designed as integrated tuner with strictly symmetrical RF-parts for use in car radios. In addition the IC provides a prestage control and an IF post amplification.

The IC is especially suitable for use in car radios with prestage control and distributed IF-selection.

The integrated circuit includes an 2-pin oscillator with symmetrical input, buffered output and a double balanced mixer for frequency conversion. The RF-input stage allows symmetrical and unsymmetrical operation. The resulting IF is amplified in a first linear IF-driver with adjustable gain and in a second IF-driver with an adjustable temperature coefficient. Between these drivers an additional IF-selection is recommended. The AGC-stage integrated for prestage control can drive PIN-Diodes as well as MOSFET's. The IC also includes a reference voltage source with high supply voltage ripple rejection.

Pin Function

Pin No.	Function
1	RF-input for mixer
2	RF-input for mixer
3	AGC-threshold
4	Ground
5	Reference voltage
6	Oscillator
7	Oscillator
8	Decoupled oscillator output (counter)
9	IF-driver temperature coefficient adjust
10	IF-driver 2 output
11	IF-driver 2 input
12	IF-driver 1 gain adjust
13	IF-driver 1 output
14	IF-driver 1 decouple
15	IF-driver 1 input
16	Supply voltage
17	AGC-time constant
18	AGC-output for the prestage control
19	Mixer output
20	Mixer output

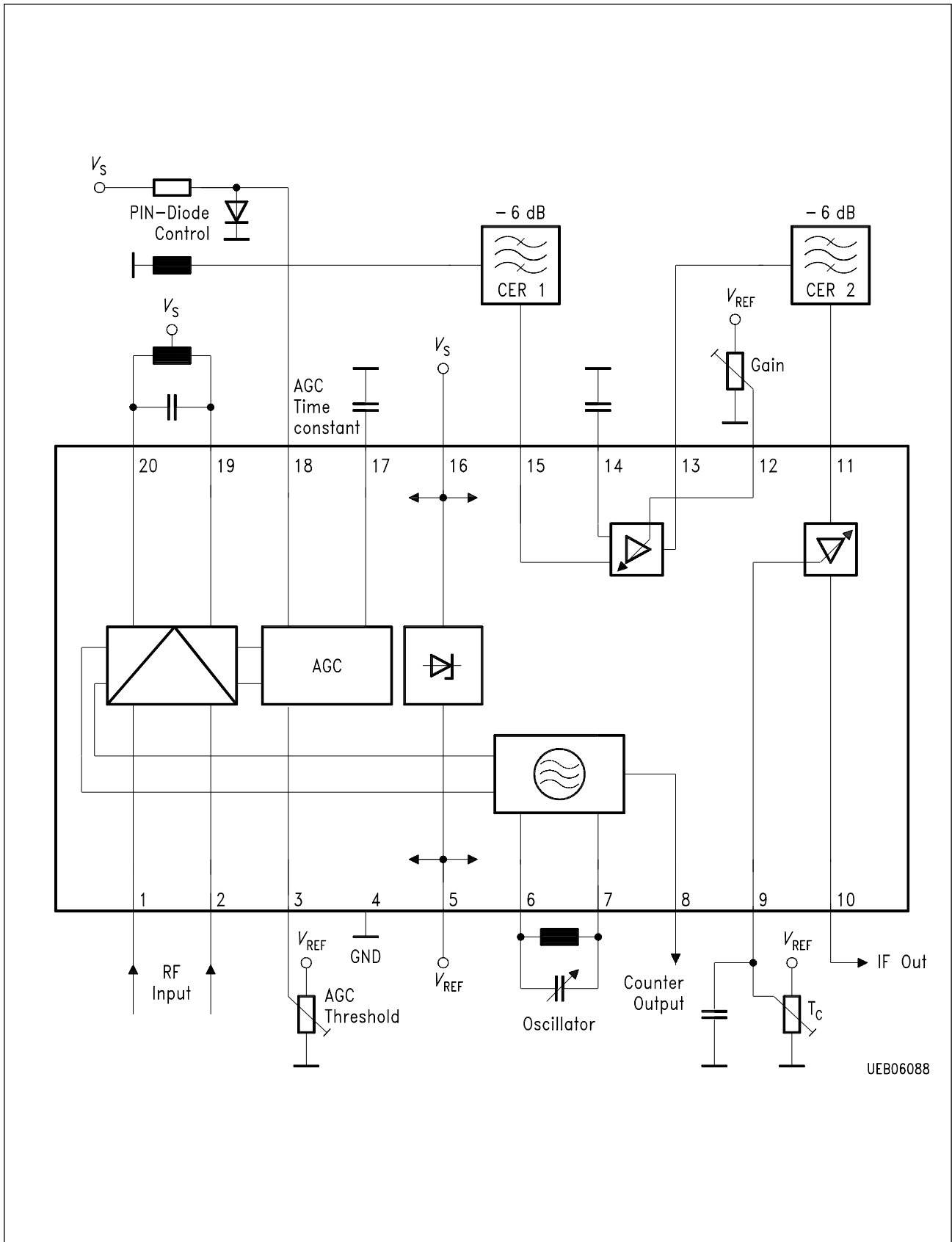

Block Diagram

Absolute Maximum Ratings

$T_A = -40$ to 85 °C

Parameter	Symbol	Limit Values		Unit	Remarks
		min.	max.		
Supply voltage	V_{16}	0	13.2	V	
Mixer	V_{19}, V_{20}	0	13.2	V	

Currents: All pins are short-circuit protected against ground.

ESD-Protection	V_{ESD}	- 4	4	kV	HBM (1.5 kΩ, 100 pF)
IF2-DC	I_9		5	mA	
Thermal resistance system-air	$R_{th SA}$		105	K/W	

Operating Range

Supply voltage	V_{16}	7.5	13.2	V	
Ambient temperature	T_A	- 40	85	°C	

Absolute Maximum Ratings

$T_A = -40$ to 85 °C

Parameter	Symbol	Limit Values		Unit	Test Condition
		min.	max.		
Supply voltage	V_{16}	0	42	mA	$I_{16} + I_{19} + I_{20}; V_{12} = 1.2$ V; $a = 0; V_3 = 4$ V
Reference voltage	V_5	4.5	5.1	V	
Total gain	G_0	21	37	dB	$G_0 = 20 \lg (V_{10}/V_{1,2}); a = 0;$ $G_{IF1} = 15$ dB; $G_{IF2} = 15$ dB (incl. - 12 dB CER1 + CER2) ¹⁾

Notes see page 5.

Absolute Maximum Ratings (cont'd)

$T_A = -40$ to 85 °C

Parameter	Symbol	Limit Values		Unit	Test Condition
		min.	max.		

Mixer

Interceptpoint third order	I_{P3}	110		dB/ μ V	$V_{1,2} \geq 100$ mVrms
Noise figure	NF		10	dB	
Mixer gain	G			dB	$G_{mix} = 20 \lg (V_{15}/V_{1,2})$ (incl. -6 dB CER1) ¹⁾
Input impedance ²⁾	R			k Ω	
Input impedance ³⁾	R_{sym}			k Ω	
Input impedance ⁴⁾	C_{sym}			pF	
Input impedance ⁵⁾	R_{asym}			k Ω	
Input impedance ⁶⁾	C_{asym}			pF	
Optimum generator for noise matching ⁷⁾	X_N			Ω	

Oscillator

Interference modulation	Δf		5	Hz	
Output signal	V_8	115		mVrms	$R_L = 300$ Ω
Output impedance (resistive)	R_8	270	390	Ω	
Operating frequency	f_{OSC}		160	MHz	

- 1) CER-filters SFE 10.7 + additional correction to -6 dB.
- 2) Internal resistance between input pin and internal V_{REF} .
- 3) Real part of sym. input impedance.
- 4) Imaginary part of sym. input impedance.
- 5) Real part of asym. input impedance.
- 6) Imaginary part of asym. input impedance.
- 7) Optimum generator impedance for noise minimum.

AC/DC Characteristics

$T_A = 25\text{ °C}$; $V_{16} = 10\text{ V}$; $f_{IF} = 10.7\text{ MHz}$, $f_{HF} = 100\text{ MHz}$; $Q_{IF} = 10$ ($C_{LC} = 100\text{ pF}$)

Parameter	Symbol	Limit Values			Unit	Test Condition
		min.	typ.	max.		

Control Voltage Generation (see diagram 4)

Control voltage for prestage	V_{17}	5.3	5.9	6.5	V	$V_3 = 2.5\text{ V}$; $V_{1,2} = 0\text{ mVrms}$
	V_{17}	0		0.1	V	$V_3 = 2.5\text{ V}$; $V_{1,2} = 30\text{ mVrms}$
Output current	I_{18}	7	10	14	mA	$V_3 = 2.5\text{ V}$; $V_{1,2} = 0\text{ mVrms}$
	I_{18}	0		0.1	mA	$V_3 = 2.5\text{ V}$; $V_{1,2} = 50\text{ mVrms}$
Saturation voltage	V_{18}			0.250	V	$V_{17} = 6\text{ V}$; $R_{16,18} = 1\text{ k}\Omega$

IF-Amplifier 1 (see diagram 2 and 5)

Input resistance	R_{15}	270	330	390	Ω	
Input capacitance	C_{15}		5		pF	
Output resistance	R_{13}	270	330	390	Ω	
Output capacitance	C_{13}		3		pF	
Voltage gain	$G_{IF1\text{ min}}$	2	5	8	dB	$G_u = 20\text{ lg} \frac{ V_{13} }{ V_{15} }$ $R_L = 330\text{ }\Omega$, $V_{12} = 4\text{ V}$
Voltage gain	$G_{IF1\text{ max}}$	21	25	29	dB	$G_u = 20\text{ lg} \frac{ V_{13} }{ V_{15} }$ $R_L = 330\text{ }\Omega$, $V_{12} = 1.2\text{ V}$
Noise figure	NF_{IF1}			10	dB	$R_6 = 330\text{ }\Omega$, $V_{12} = 1.2\text{ V}$

AC/DC Characteristics (cont'd)

$T_A = 25\text{ °C}$; $V_{16} = 10\text{ V}$; $f_{IF} = 10.7\text{ MHz}$, $f_{HF} = 100\text{ MHz}$; $Q_{IF} = 10$ ($C_{LC} = 100\text{ pF}$)

Parameter	Symbol	Limit Values			Unit	Test Condition
		min.	typ.	max.		
IF-Amplifier 2 (see diagram 1 and 3)						
Input resistance	R_{11}		330		Ω	
Input capacitance	C_{11}		6		pF	
Output resistance	R_{10}	270	330	390	Ω	
Output capacitance	C_{10}		3		pF	
Voltage gain	G_{IF2}	13	15	17	dB	$G_u = 20 \lg \frac{ V_{10} }{ V_{11} }$ $R_L = 330\ \Omega, a = 0, T_A = 300\text{ K}$
Noise figure	NF_{IF2}		6	8	dB	$R_G = 330\ \Omega, R_L = 330\ \Omega$
Temp. coefficient range	a	0		3		$V/V_Q = (T/T_A) a$
Gain versus range temp.	G/G_0		0.09		dB/K	$a = 3$
Gain versus range temp.	G/G_0		0		dB/K	$a = 0$

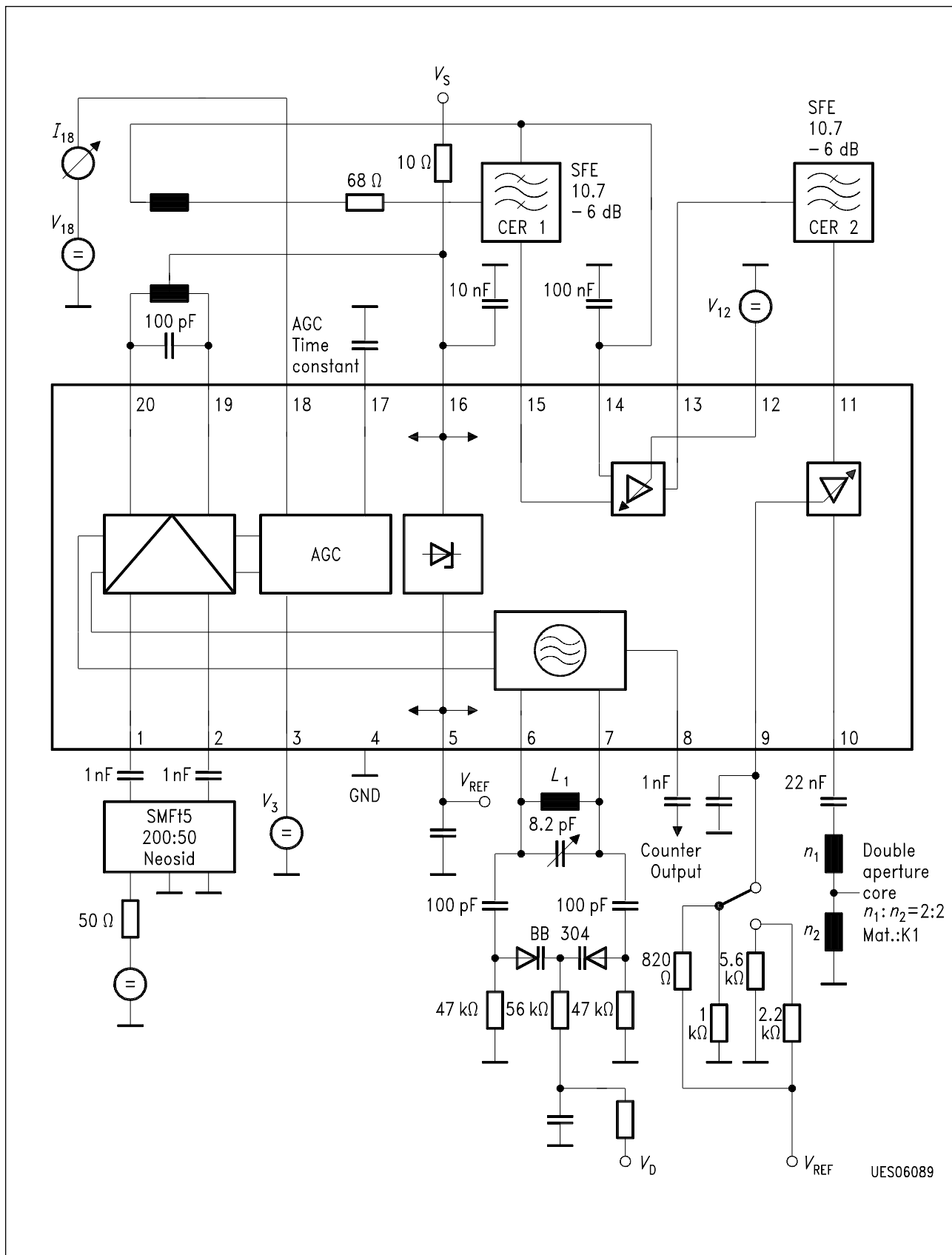

UES06089

Test Circuit

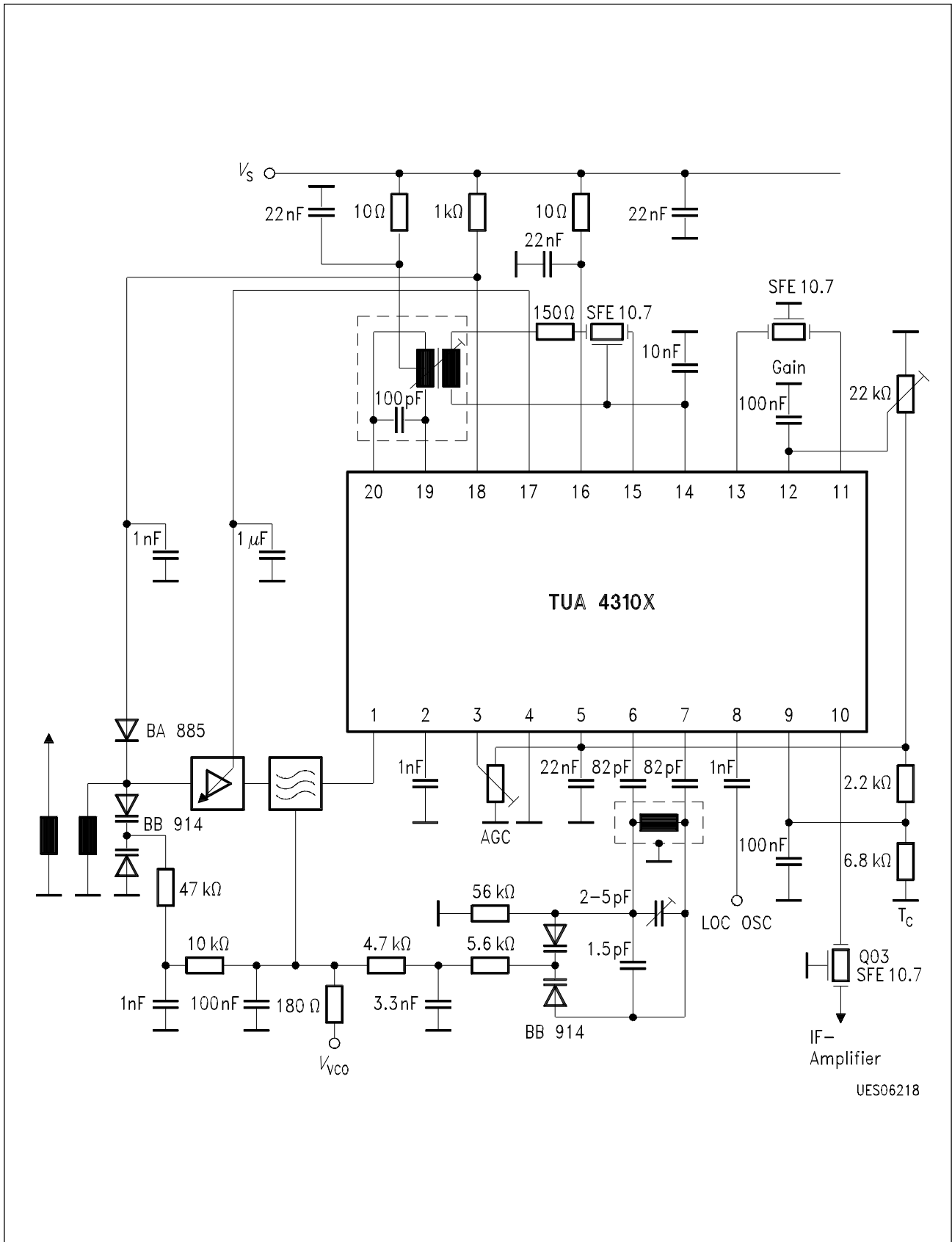

Application Circuit

Diagram 1
Computing the T_C Compensator
IF-Amplifier

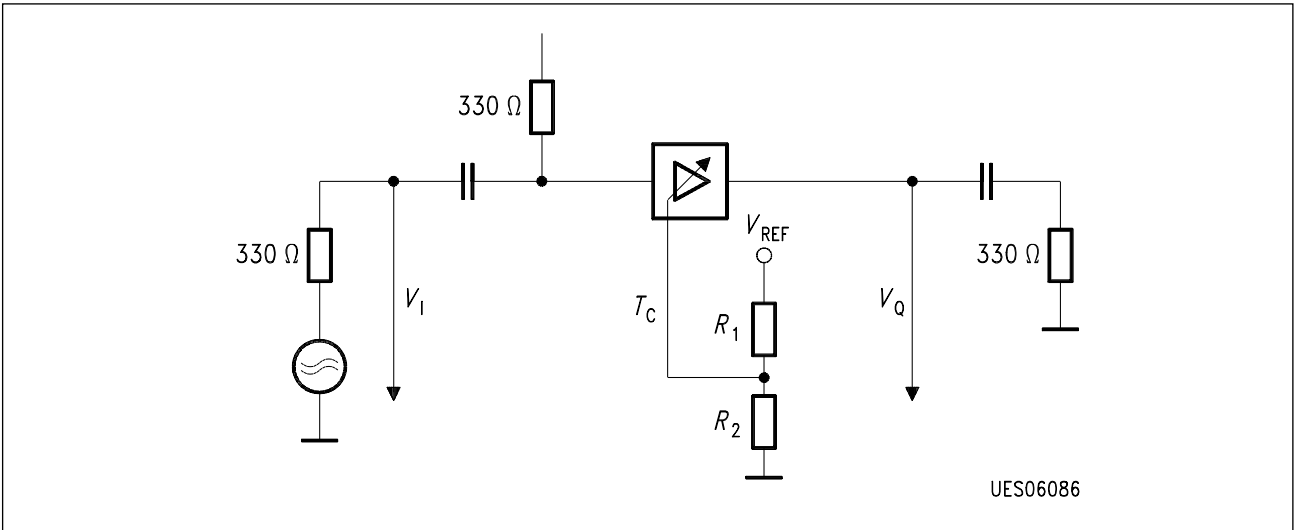

G_0 : Gain (15 dB = 5.62) $T_A = 300$ K
 α : T_C gradient ($\alpha = 0 \dots 3$)

$$R_1 = \frac{15231}{G_0 (1.2 + 0.8 \alpha)} = \begin{matrix} [2558 \Omega \text{ for } \alpha = 0] \\ [753 \Omega \text{ for } \alpha = 3] \end{matrix}$$

$$R_2 = \frac{2R_1 (1.5 + \alpha)}{1 + 2\alpha} = \begin{matrix} [6775 \Omega \text{ for } \alpha = 0] \\ [968 \Omega \text{ for } \alpha = 3] \end{matrix}$$

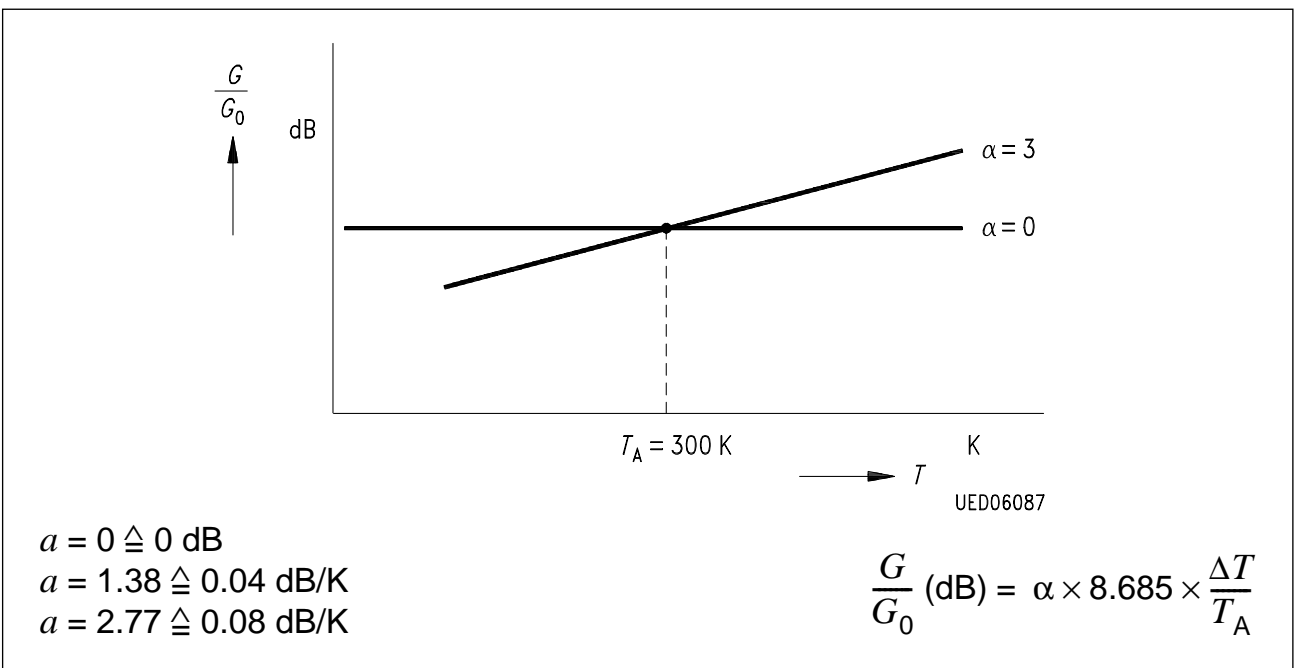

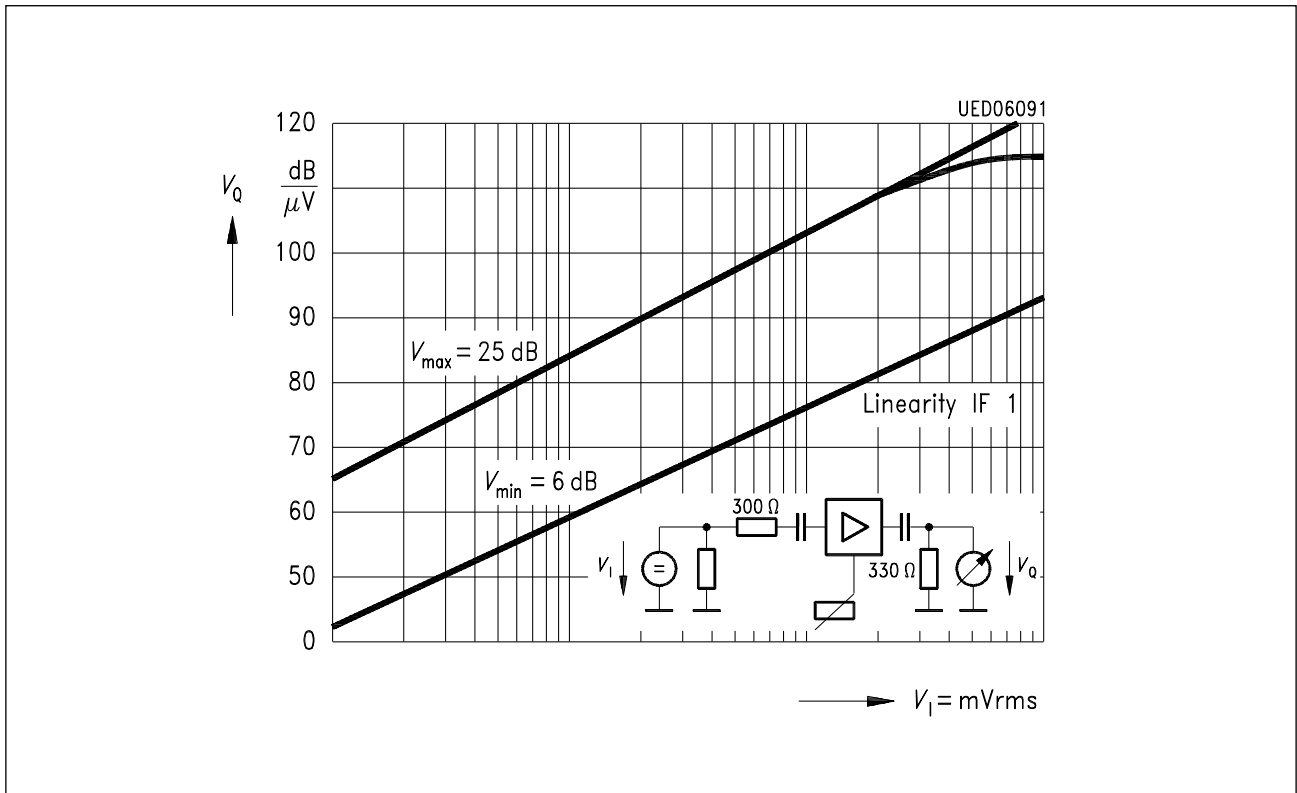

Diagram 2

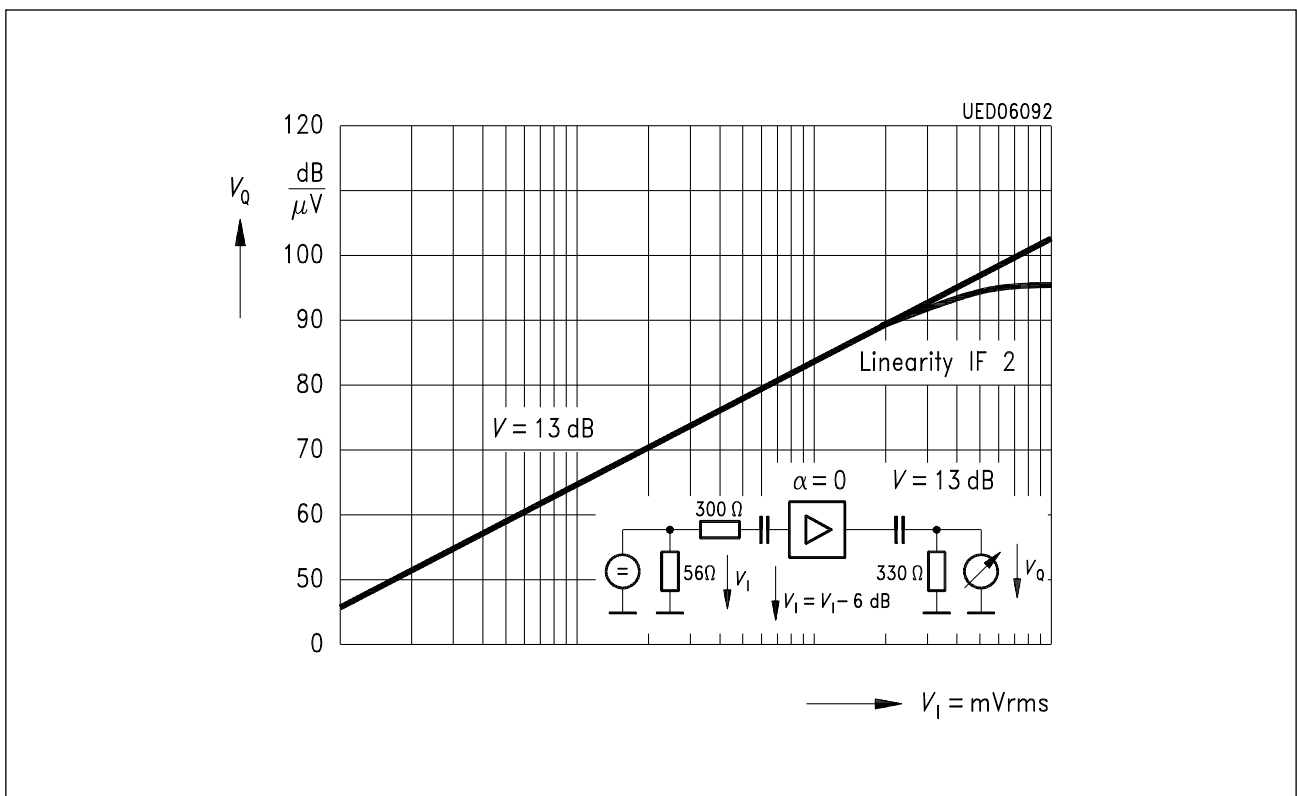

Diagram 3

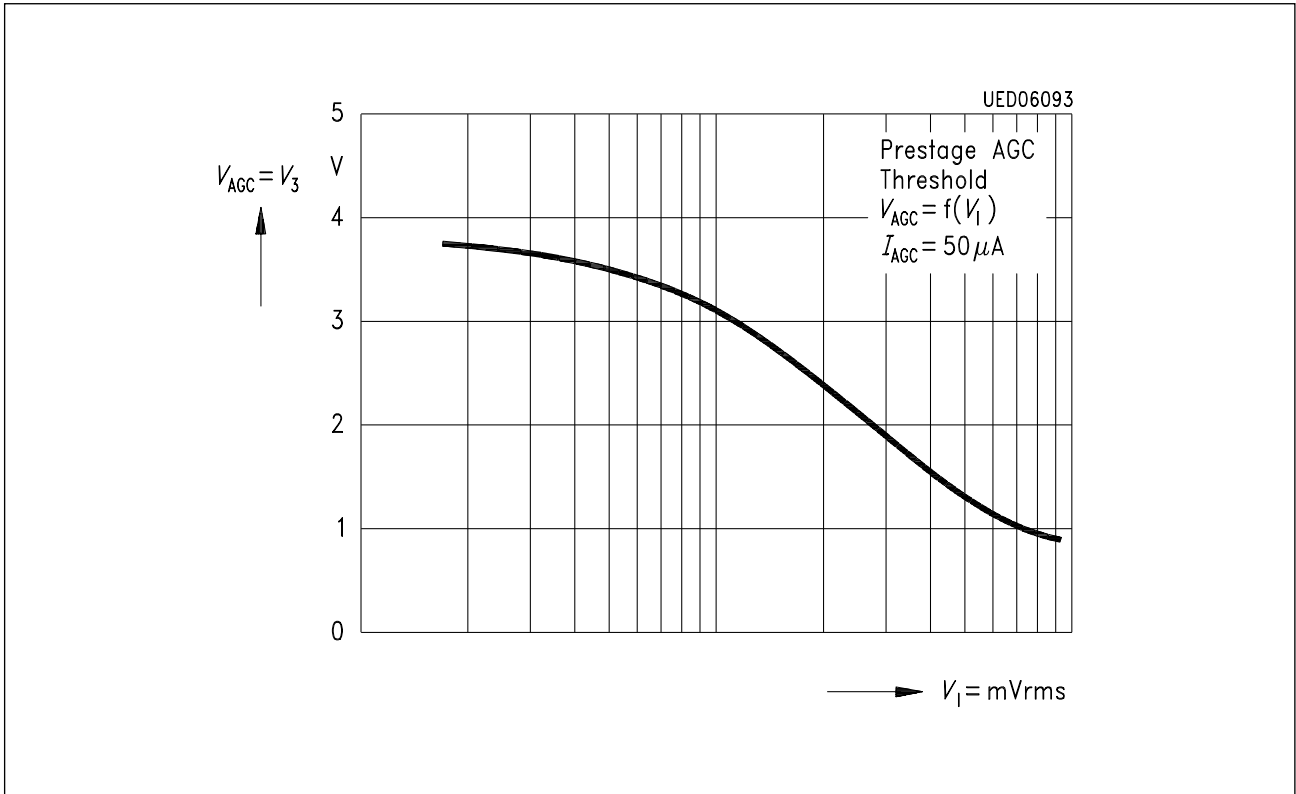

Diagram 4

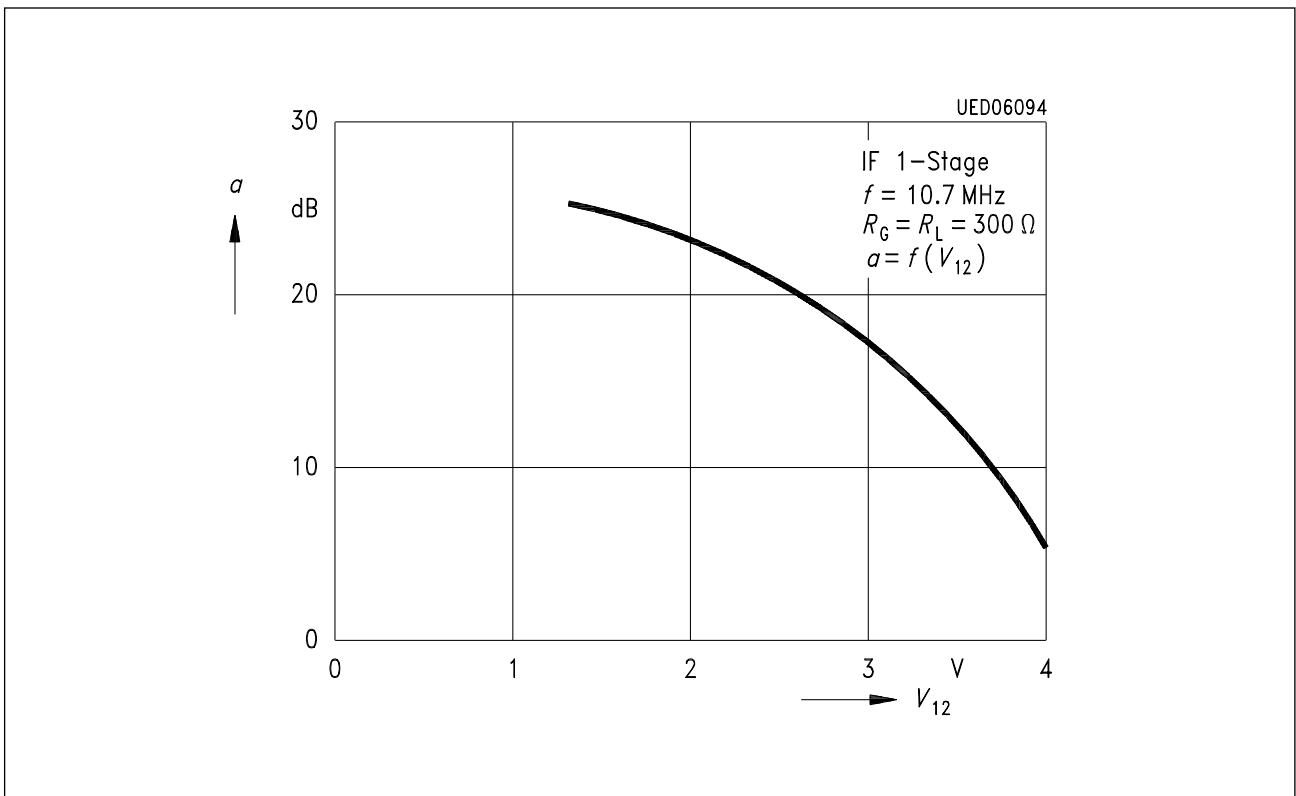

Diagram 5

