

High-Power NPN Silicon Transistors

... designed for use in industrial–military power amplifier and switching circuit applications.

- High Collector–Emitter Sustaining Voltage —
 $V_{CEO(sus)} = 100 \text{ Vdc (Min) — 2N6338}$
 $= 120 \text{ Vdc (Min) — 2N6339}$
 $= 140 \text{ Vdc (Min) — 2N6340}$
 $= 150 \text{ Vdc (Min) — 2N6341}$
- High DC Current Gain —
 $h_{FE} = 30 - 120 @ I_C = 10 \text{ Adc}$
 $= 12 \text{ (Min) } @ I_C = 25 \text{ Adc}$
- Low Collector–Emitter Saturation Voltage —
 $V_{CE(sat)} = 1.0 \text{ Vdc (Max) } @ I_C = 10 \text{ Adc}$
- Fast Switching Times @ $I_C = 10 \text{ Adc}$
 $t_r = 0.3 \mu\text{s (Max)}$
 $t_s = 1.0 \mu\text{s (Max)}$
 $t_f = 0.25 \mu\text{s (Max)}$
- Complement to 2N6436–38

*MAXIMUM RATINGS

Rating	Symbol	2N6338	2N6339	2N6340	2N6341	Unit
Collector–Base Voltage	V_{CB}	120	140	160	180	Vdc
Collector–Emitter Voltage	V_{CEO}	100	120	140	150	Vdc
Emitter–Base Voltage	V_{EB}	6.0				Vdc
Collector Current Continuous	I_C					A
Peak						
Base Current	I_B	10				A
Total Device Dissipation @ $T_C = 25^\circ\text{C}$ Derate above 25°C	P_D	200				Watts
Operating and Storage Junction Temperature Range	T_J, T_{stg}	–65 to +200				$^\circ\text{C}$

THERMAL CHARACTERISTICS

Characteristic	Symbol	Max	Unit
Thermal Resistance, Junction to Case	θ_{JC}	0.875	$^\circ\text{C/W}$

* Indicates JEDEC Registered Data.

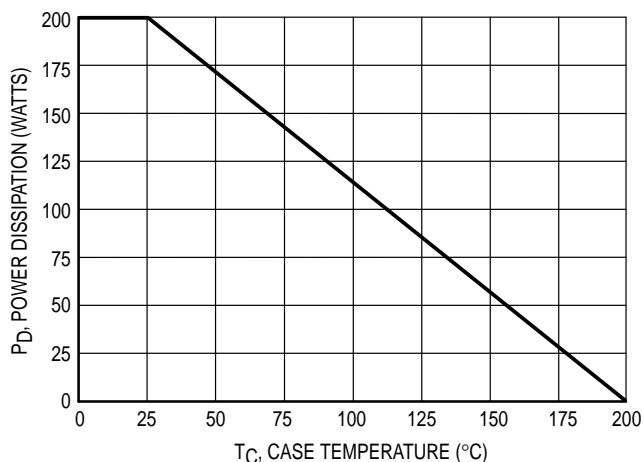

Figure 1. Power Derating

Preferred devices are Motorola recommended choices for future use and best overall value.

REV 7

2N6338
2N6339
2N6340
2N6341*

*Motorola Preferred Device

25 AMPERE
POWER TRANSISTORS
NPN SILICON
100, 120, 140, 150 VOLTS
200 WATTS

CASE 1–07
TO–204AA
(TO–3)

2N6338 2N6339 2N6340 2N6341

*ELECTRICAL CHARACTERISTICS ($T_C = 25^\circ\text{C}$ unless otherwise noted)

Characteristic	Symbol	Min	Max	Unit	
OFF CHARACTERISTICS					
Collector–Emitter Sustaining Voltage (1) ($I_C = 50 \text{ mAdc}$, $I_B = 0$)	2N6338 2N6339 2N6340 2N6341	$V_{CEO(sus)}$	100 120 140 150	— — — —	Vdc
Collector Cutoff Current ($V_{CE} = 50 \text{ Vdc}$, $I_B = 0$) ($V_{CE} = 60 \text{ Vdc}$, $I_B = 0$) ($V_{CE} = 70 \text{ Vdc}$, $I_B = 0$) ($V_{CE} = 75 \text{ Vdc}$, $I_B = 0$)	2N6338 2N6339 2N6340 2N6341	I_{CEO}	— — — —	50 50 50 50	μAdc
Collector Cutoff Current ($V_{CE} = \text{Rated } V_{CEO}$, $V_{EB(off)} = 1.5 \text{ Vdc}$) ($V_{CE} = \text{Rated } V_{CEO}$, $V_{EB(off)} = 1.5 \text{ Vdc}$, $T_C = 150^\circ\text{C}$)		I_{CEX}	— —	10 1.0	μAdc mAdc
Collector Cutoff Current ($V_{CB} = \text{Rated } V_{CB}$, $I_E = 0$)		I_{CBO}	—	10	μAdc
Emitter Cutoff Current ($V_{BE} = 6.0 \text{ Vdc}$, $I_C = 0$)		I_{EBO}	—	100	μAdc

ON CHARACTERISTICS (1)

DC Current Gain ($I_C = 0.5 \text{ Adc}$, $V_{CE} = 2.0 \text{ Vdc}$) ($I_C = 10 \text{ Adc}$, $V_{CE} = 2.0 \text{ Vdc}$) ($I_C = 25 \text{ Adc}$, $V_{CE} = 2.0 \text{ Vdc}$)	h_{FE}	50 30 12	— 120 —	—
Collector Emitter Saturation Voltage ($I_C = 10 \text{ Adc}$, $I_B = 1.0 \text{ Adc}$) ($I_C = 25 \text{ Adc}$, $I_B = 2.5 \text{ Adc}$)	$V_{CE(sat)}$	— —	1.0 1.8	Vdc
Base–Emitter Saturation Voltage ($I_C = 10 \text{ Adc}$, $I_B = 1.0 \text{ Adc}$) ($I_C = 25 \text{ Adc}$, $I_B = 2.5 \text{ Adc}$)	$V_{BE(sat)}$	— —	1.8 2.5	Vdc
Base–Emitter On Voltage ($I_C = 10 \text{ Adc}$, $V_{CE} = 2.0 \text{ Vdc}$)	$V_{BE(on)}$	—	1.8	Vdc

DYNAMIC CHARACTERISTICS

Current–Gain — Bandwidth Product (2) ($I_C = 1.0 \text{ Adc}$, $V_{CE} = 10 \text{ Vdc}$, $f_{test} = 10 \text{ MHz}$)	f_T	40	—	MHz
Output Capacitance ($V_{CB} = 10 \text{ Vdc}$, $I_E = 0$, $f = 0.1 \text{ MHz}$)	C_{ob}	—	300	pF

SWITCHING CHARACTERISTICS

Rise Time ($V_{CC} \approx 80 \text{ Vdc}$, $I_C = 10 \text{ Adc}$, $I_{B1} = 1.0 \text{ Adc}$, $V_{BE(off)} = 6.0 \text{ Vdc}$)	t_r	—	0.3	μs
Storage Time ($V_{CC} \approx 80 \text{ Vdc}$, $I_C = 10 \text{ Adc}$, $I_{B1} = I_{B2} = 1.0 \text{ Adc}$)	t_s	—	1.0	μs
Fall Time ($V_{CC} \approx 80 \text{ Vdc}$, $I_C = 10 \text{ Adc}$, $I_{B1} = I_{B2} = 1.0 \text{ Adc}$)	t_f	—	0.25	μs

* Indicates JEDEC Registered Data.

(1) Pulse Test: Pulse Width $\leq 300 \mu\text{s}$, Duty Cycle $\leq 2.0\%$.

(2) $f_T = |h_{fe}| \cdot f_{test}$.

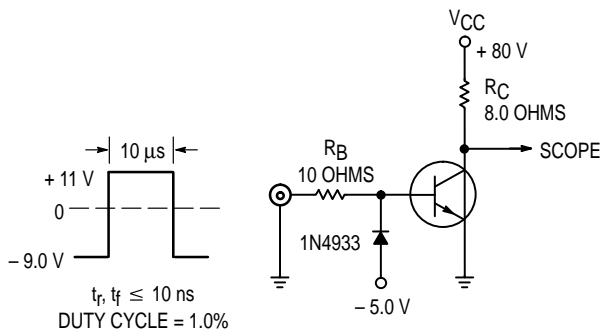

NOTE: For information on Figures 3 and 6, R_B and R_C were varied to obtain desired test conditions.

Figure 2. Switching Time Test Circuit

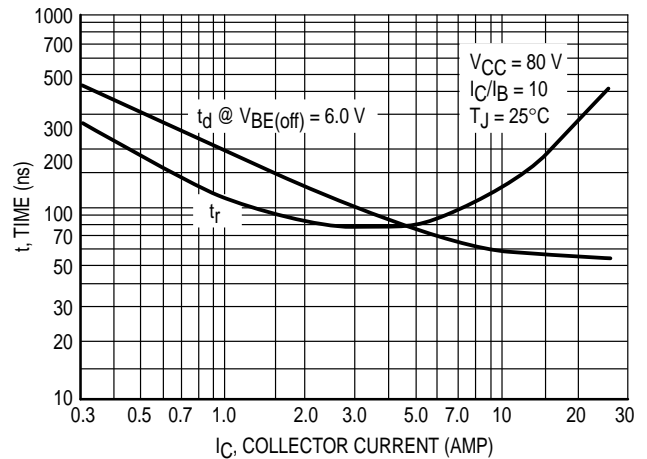

Figure 3. Turn–On Time

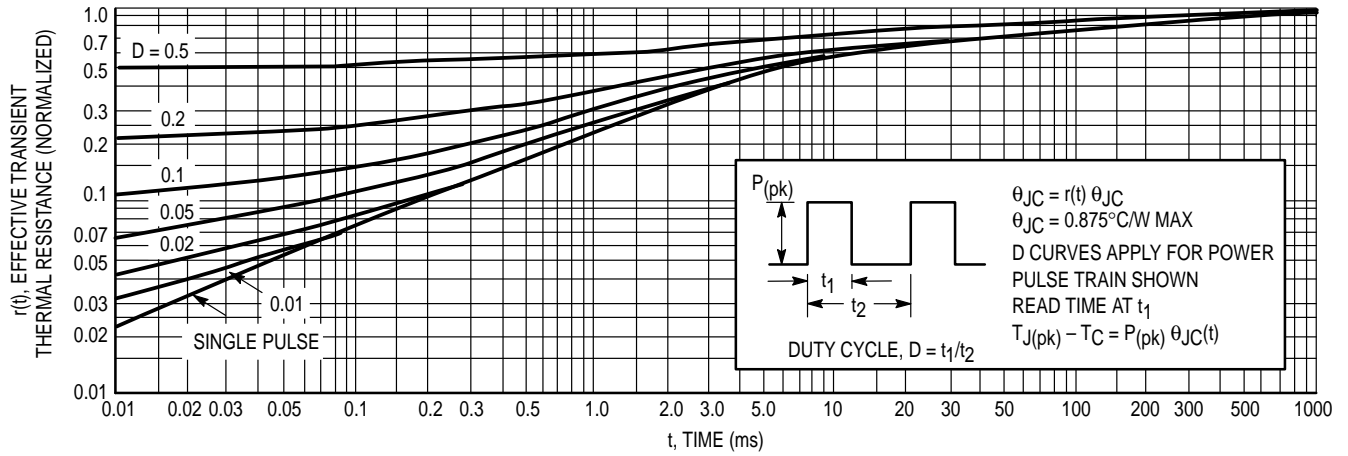

Figure 4. Thermal Response

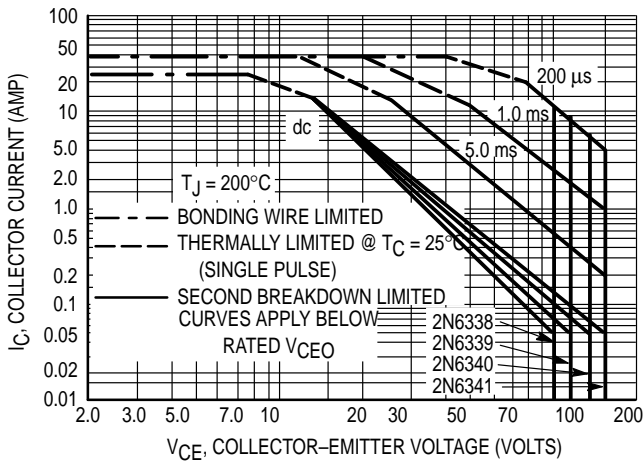

Figure 5. Active Region Safe Operating Area

There are two limitations on the power handling ability of a transistor: average junction temperature and second breakdown. Safe operating area curves indicate I_C - V_{CE} limits of the transistor that must be observed for reliable operation; i.e., the transistor must not be subjected to greater dissipation than the curves indicate.

The data of Figure 5 is based on $T_{J(pk)} = 200^\circ\text{C}$; T_C is variable depending on conditions. Second breakdown pulse limits are valid for duty cycles to 10% provided $T_{J(pk)} \leq 200^\circ\text{C}$. $T_{J(pk)}$ may be calculated from the data in Figure 4. At high case temperatures, thermal limitations will reduce the power that can be handled to values less than the limitations imposed by second breakdown.

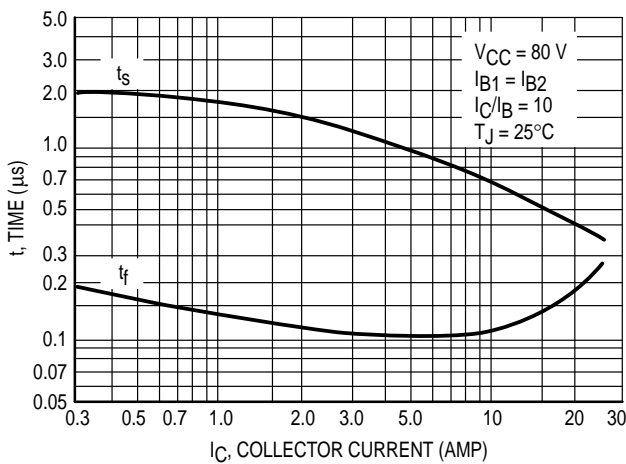

Figure 6. Turn-Off Time

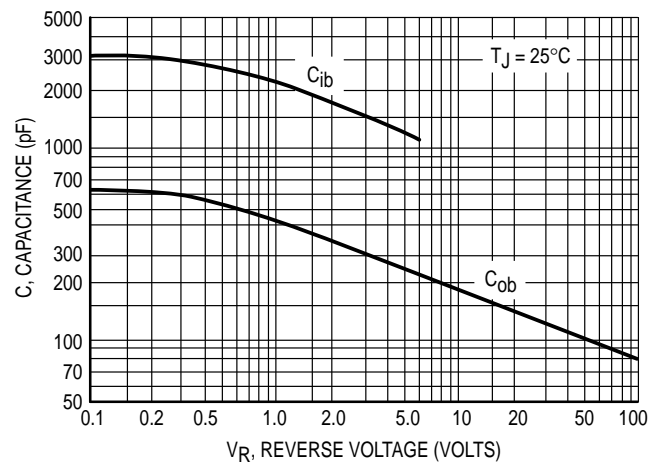
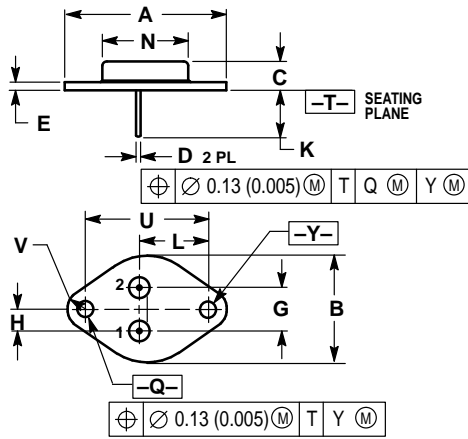

Figure 7. Capacitance

PACKAGE DIMENSIONS



- NOTES:
 1. DIMENSIONING AND TOLERANCING PER ANSI Y14.5M, 1982.
 2. CONTROLLING DIMENSION: INCH.
 3. ALL RULES AND NOTES ASSOCIATED WITH REFERENCED TO-204AA OUTLINE SHALL APPLY.

DIM	INCHES		MILLIMETERS	
	MIN	MAX	MIN	MAX
A	1.550 REF		39.37 REF	
B	—	1.050	—	26.67
C	0.250	0.335	6.35	8.51
D	0.038	0.043	0.97	1.09
E	0.055	0.070	1.40	1.77
G	0.430 BSC		10.92 BSC	
H	0.215 BSC		5.46 BSC	
K	0.440	0.480	11.18	12.19
L	0.665 BSC		16.89 BSC	
N	—	0.830	—	21.08
Q	0.151	0.165	3.84	4.19
U	1.187 BSC		30.15 BSC	
V	0.131	0.188	3.33	4.77

STYLE 1:
 PIN 1: BASE
 2: EMITTER
 CASE: COLLECTOR

CASE 1-07
 TO-204AA (TO-3)
 ISSUE Z

Motorola reserves the right to make changes without further notice to any products herein. Motorola makes no warranty, representation or guarantee regarding the suitability of its products for any particular purpose, nor does Motorola assume any liability arising out of the application or use of any product or circuit, and specifically disclaims any and all liability, including without limitation consequential or incidental damages. "Typical" parameters can and do vary in different applications. All operating parameters, including "Typicals" must be validated for each customer application by customer's technical experts. Motorola does not convey any license under its patent rights nor the rights of others. Motorola products are not designed, intended, or authorized for use as components in systems intended for surgical implant into the body, or other applications intended to support or sustain life, or for any other application in which the failure of the Motorola product could create a situation where personal injury or death may occur. Should Buyer purchase or use Motorola products for any such unintended or unauthorized application, Buyer shall indemnify and hold Motorola and its officers, employees, subsidiaries, affiliates, and distributors harmless against all claims, costs, damages, and expenses, and reasonable attorney fees arising out of, directly or indirectly, any claim of personal injury or death associated with such unintended or unauthorized use, even if such claim alleges that Motorola was negligent regarding the design or manufacture of the part. Motorola and are registered trademarks of Motorola, Inc. Motorola, Inc. is an Equal Opportunity/Affirmative Action Employer.

How to reach us:
 USA / EUROPE: Motorola Literature Distribution;
 P.O. Box 20912; Phoenix, Arizona 85036. 1-800-441-2447

JAPAN: Nippon Motorola Ltd.; Tatsumi-SPD-JLDC, Toshikatsu Otsuki,
 6F Seibu-Butsuryu-Center, 3-14-2 Tatsumi Koto-Ku, Tokyo 135, Japan. 03-3521-8315

MFAX: RMFAX0@email.sps.mot.com - TOUCHTONE (602) 244-6609
 INTERNET: http://Design-NET.com

HONG KONG: Motorola Semiconductors H.K. Ltd.; 8B Tai Ping Industrial Park,
 51 Ting Kok Road, Tai Po, N.T., Hong Kong. 852-26629298

