

## Silicon Switching Diode Array

- For high speed switching applications
- Common anode

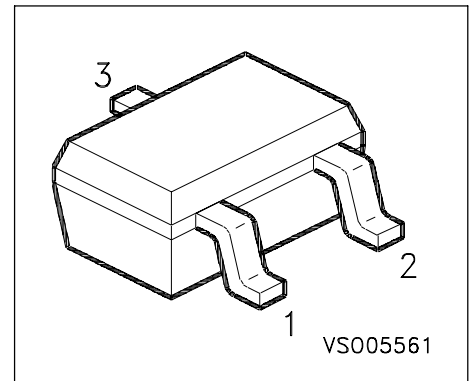
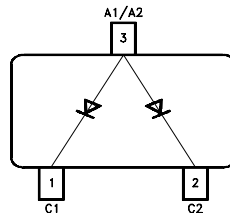

Type	Marking	Ordering Code	Pin Configuration			Package
BAW 56W	A1s	Q62702-A1031	1 = C1	2=C2	3=A1/A2	SOT-323

### Maximum Ratings per Diode

Parameter	Symbol	Values	Unit
Diode reverse voltage	$V_R$	70	V
Peak reverse voltage	$V_{RM}$	70	
Forward current	$I_F$	200	mA
Surge forward current, $t = 1 \mu s$	$I_{FS}$	4.5	A
Total Power dissipation $T_S = 103 \text{ }^\circ\text{C}$	$P_{tot}$	250	mW
Junction temperature	$T_j$	150	$^\circ\text{C}$
Storage temperature	$T_{stg}$	- 65 ... + 150	

### Thermal Resistance

Junction ambient <sup>1)</sup>	$R_{thJA}$	$\leq 460$	K/W
Junction - soldering point	$R_{thJS}$	$\leq 190$	

1) Package mounted on epoxy pcb 40mm x 40mm x 1.5mm / 0.5cm<sup>2</sup> Cu

**Electrical Characteristics** at  $T_A=25^\circ\text{C}$ , unless otherwise specified

Parameter	Symbol	Values			Unit
		min.	typ.	max.	

**DC characteristics per Diode**

Breakdown voltage $I_{(BR)} = 100 \mu\text{A}$	$V_{(BR)}$	70	-	-	V
Forward voltage $I_F = 1 \text{ mA}$	$V_F$	-	-	715	
$I_F = 10 \text{ mA}$		-	-	855	
$I_F = 50 \text{ mA}$		-	-	1000	
$I_F = 150 \text{ mA}$		-	-	1250	
Reverse current $V_R = 70 \text{ V}, T_A = 25^\circ\text{C}$	$I_R$	-	-	2.5	$\mu\text{A}$
$V_R = 25 \text{ V}, T_A = 150^\circ\text{C}$		-	-	30	
$V_R = 70 \text{ V}, T_A = 150^\circ\text{C}$		-	-	50	

**AC characteristics per Diode**

Diode capacitance $V_R = 0 \text{ V}, f = 1 \text{ MHz}$	$C_D$	-	-	2	pF
Reverse recovery time $I_F = 10 \text{ mA}, I_R = 10 \text{ mA}, R_L = 100 \Omega$ $t_{rr}$ measured at 1 mA	$t_{rr}$	-	-	6	ns

### Forward current $I_F = f(T_A^*; T_S)$

\* Package mounted on epoxy

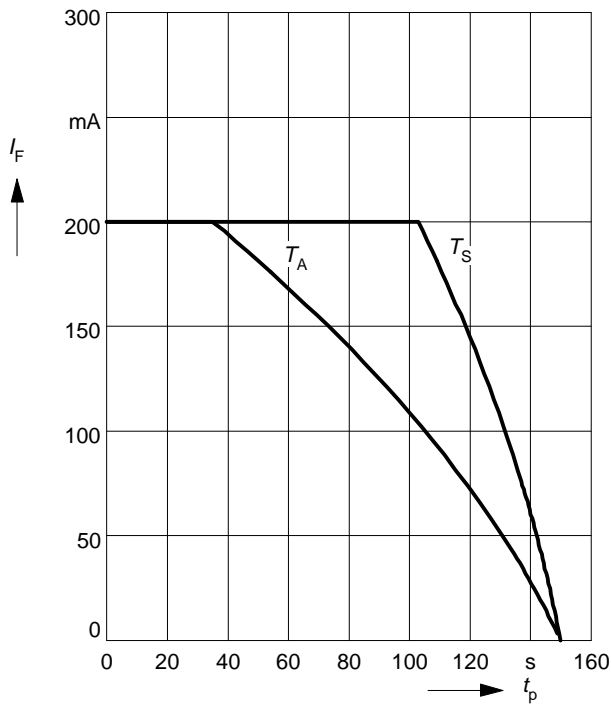

### Permissible Pulse Load $R_{thJS} = f(t_p)$

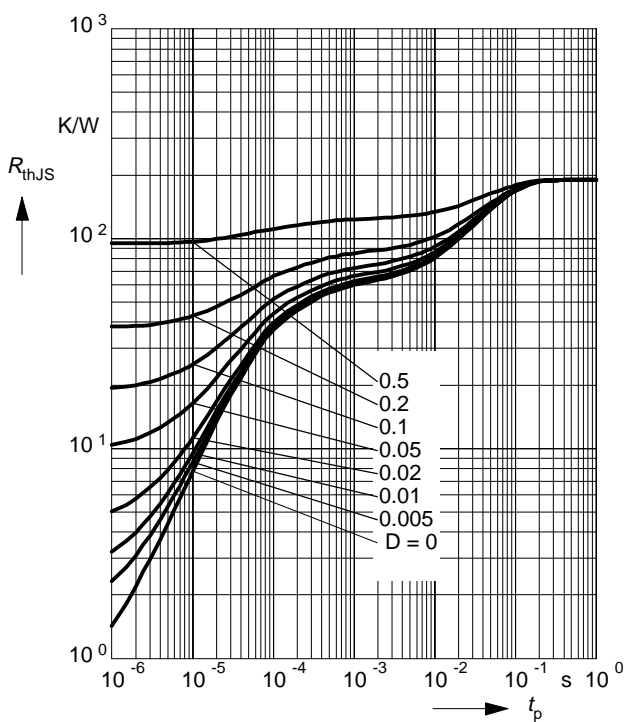

### Forward current $I_F = f(V_F)$

$T_A = 25^\circ\text{C}$

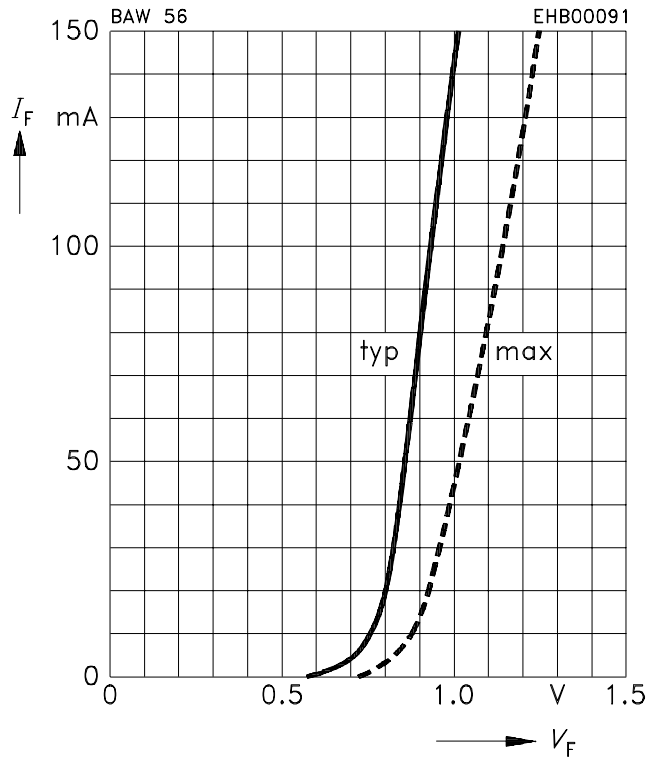

### Permissible Pulse Load $I_{Fmax}/I_{FDC} = f(t_p)$

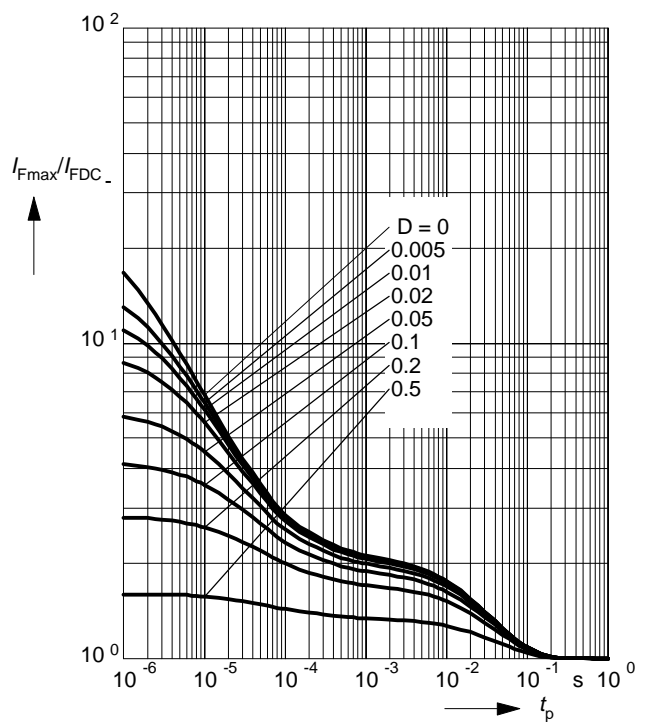

**Forward voltage  $V_F = f(T_A)$**

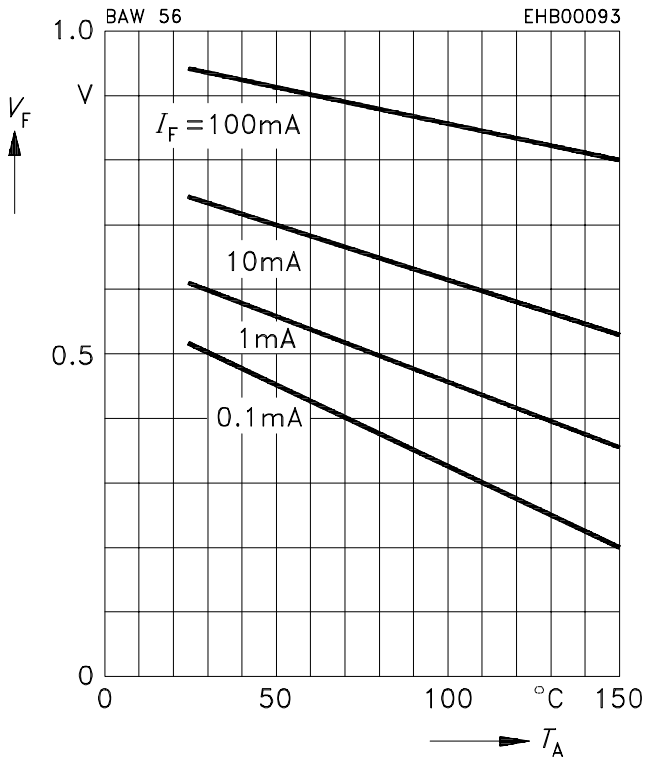

**Reverse current  $I_R = f(T_A)$**

